



## The Audi A1

Pricing and Specification Guide  
Valid from August 2011

# Personalising your Audi A1

This guide has been designed to help you tailor and price your Audi A1 quickly and logically. At the back, you will find information on CO2 emissions-based taxation and the other services offered by Audi, including Finance and Insurance. You can also configure your Audi A5 Coupé online at [audi.co.uk](http://audi.co.uk).

You might also like to consider Audi Complete: a simple way to take care of servicing and maintenance costs for your Audi in a single package. You pay a one-off or monthly fee and we'll cover all your servicing, maintenance and tyres for the next three years including your first MOT and a full 5-year warranty. It means you only have to pay for fuel, insurance and your Road Fund Licence. So you can be reassured that your car will be maintained by trained Audi Technicians, using genuine Audi parts.

## Audi Complete™

### The Audi A1

Efficiency	8
Engines	10
Transmission	11
Technology	12

### Model details and prices

SE model equipment	14
Sport model equipment	15
S line model equipment	16
A1 Editions: Competition Line	18
Model prices	20

### Colour and upholstery

Paint	22
Roof contrast line	24
Upholstery	26
Audi exclusive	28
Media Style package	34
Colour and trim guide	36
Air vent sleeves	38

### Options

Wheels, tyres and suspension	40
Packages	42
Audio and communication	44
Steering wheels	46
Safety and security	46
Exterior equipment	47
Interior equipment	48
Service plan and warranty	50
Merchandise	51
Accessories	52

### Technical details

Technical data	53
Dimensions	55
Additional information	56
Pricing information	58





## Vorsprung durch Technik

Three words that express the very essence of Audi. Vorsprung durch Technik isn't a slogan. It's our way of seeing the world. It is the driving force behind our history of innovation that continues into the 21st century. Indeed, many technologies that Audi pioneered remain in our cars today. Some are milestones in the history of the motorcar.

From our beginnings in 1899, to the Auto Union team's Grand Prix successes in the 1930s and our more recent wins at Le Mans, we have always been at the forefront of the motor industry.

Vorsprung durch Technik makes us who we are. To see more of its influence, just read on.

## The Audi A1

Sometimes it's the smallest things that contain the biggest ideas: the humble paper clip, the tungsten filament, the pocket army knife. The Audi A1 is no exception. This car is a distillation of all the great technologies which came before it – many of which appear in the flagship A8.

Featuring TDI® and FSI® engines born and bred on the racetrack and cutting edge technologies such as Start-Stop and S tronic,® this is amongst our most efficient cars.





## Efficiency

At Audi, doing less is something we're trying to do more of. We're working to use less fuel, release less CO<sub>2</sub> and waste less energy. It's why we've incorporated a number of more efficient technologies into the Audi A1.

### **TDI® and FSI®**

Inside the engine of the A1 you'll find the same advanced fuel-injection technology that's driven us to win after win at Le Mans. With TDI® and FSI®, fuel is injected directly into the engine's chambers so that combustion is timed right down to the millisecond. As a result, waste is minimised and you get the most from every last drop of fuel.

### **Automatic Start-Stop function**

In traffic, your car still uses fuel and releases CO<sub>2</sub>, even when it's stationary. The automatic Start-Stop function is a smart new technology that counteracts this problem by being able to switch off the engine when your A1 comes to a standstill. As soon as you touch the clutch (or brake pedal on S tronic® models), the car restarts. By only using the engine when it's needed, it helps to save fuel and reduce emissions – especially in heavy urban traffic.





### **Recuperation**

When a vehicle brakes, the discs convert the kinetic energy into thermal energy, which is wasted as it cannot be used. With a recuperation system, like the one in the Audi A1, the kinetic energy is converted into useful electrical energy. The way it works is simple. While the car is coasting or braking, the alternator voltage is raised above the level of the basic electrical system, which enables the alternator to generate electrical energy and store it temporarily in the battery. When the vehicle accelerates, this energy is used to relieve the load on the alternator, resulting in a fuel saving of up to 3%.



## Engines

### Petrol

FSI® direct-injection technology is a unique Audi innovation that was originally developed for the Le Mans 24-hour endurance race to deliver more power and torque, as well as enhanced fuel efficiency. Precisely the right amount of fuel and air are injected into the combustion chambers, enabling the engine to 'breathe' more easily. It results in reduced heat loss and increased output, with around a 15% reduction in fuel consumption and significantly lower exhaust emissions. We've also developed TFSI®, with turbocharging – giving cars an extra injection of power.

### Diesel

We introduced TDI® to the roads in 1989, marking a departure from the noisy, fuel-thirsty diesel engines of the past. And since then, we've continuously refined it, recently developing common rail technology. Under this system, a series of piezo injectors use electrical charge to precisely control the amount of fuel injected into the engine. As well as reducing noise, this allows combustion to happen at a lower temperature, with less oxygen, which lowers emissions.





## Transmission

### **S tronic®**

Driving is all about thinking ahead, which is just what the S tronic® dual-clutch transmission does. It works almost as two separate systems, one engaging the odd-numbered and the other the even-numbered gears. So when you're accelerating in second, it has third gear waiting for you. And once you make the switch, it's already thinking about fourth. With two clutches working together, you can change gears almost instantly while experiencing smooth, uninterrupted power. S tronic® is available on 1.4 TFSI models.

# Technology

## Concert radio

A technologically advanced car needs a sound system to match – one designed to enhance the thrilling experience of every drive. The standard Concert radio incorporates an MP3-compatible CD player, AUX-IN socket, SD memory card reader and a 6.5-inch retractable display. Six high-performance speakers complete with two ‘tweeters’ work together to produce a sound to enliven any journey.

## BOSE® surround sound system

The A1’s exterior is a perfect example of modern design. This is complemented inside, where you’ll find state-of-the-art technology throughout the cabin. Options include a BOSE® surround sound system with 14 high performance speakers and a sub-woofer. The speaker housings are enhanced with bevelled edges. Thanks to a 10-channel amplifier, the speakers deliver 465 Watts of rich and clear sound, creating a rewarding listening experience – whatever kind of music you’re listening to. For more information, please see page 44.

## LED technology

Xenon headlights are available on all trim levels of the Audi A1. Upgrade to Xenon Plus headlights and you’ll also benefit from LED daytime running lights, which provide a distinctive look with a unique, flowing design. Special reflectors focus the light emitted by each diode to create a powerful, uniform beam. And this technology also features in the rear lights, creating a striking design that is unmistakably Audi. For more information, please see pages 42 and 47.

## Technology package

The Audi A1 keeps many of its most impressive technologies concealed beneath sculptured bodywork and interior finishing. The optional technology package, with its HDD-based Satellite Navigation system, for example, gives you intuitive control of your car’s communication, information, navigation and entertainment functions. The MMI eight-way joystick lets you navigate maps quickly and easily in both 2D and 3D, while you can also use the Audi Music Interface to connect your iPod or the Bluetooth interface to stream music wirelessly from your mobile phone. There’s plenty of room to store your favourites too, as 20GB of the 40GB hard drive can be used to store up to 8,000 songs. For more information, please see page 42.

## Mobile telephone preparation – High with online services

If you choose the technology package, you can also specify mobile telephone preparation – High, with online services. A world first in this class of car, it lets you keep completely up to date with the latest online services and turns your A1 into a Wi-Fi hotspot. So when you take a trip, you won’t just be able to check the weather before you leave, you’ll also have access to the latest forecast throughout your journey. Thanks to Wi-Fi connectivity, your passengers can access the internet while you drive, so they can check emails and browse the web using a laptop or smart phone. And finding your destination is easier too, as navigation through Google Earth makes it possible to identify real-life details and search for local landmarks and other points of interest. For more information please see page 45.





## SE model equipment

All A1 models have the following items of standard equipment

### Engine

Automatic Start-Stop function\* for greater fuel and CO<sub>2</sub> efficiency. Comprising;

- Recuperation for optimal energy utilisation
- Energy saving tips feature in Driver's Information System: including gearshift indicator (if Driver's Information System is fitted)

### Wheels, tyres and suspension

15" x 6.5J '7-arm' design alloy wheels with 205/55 R15 tyres

Locking wheel bolts

Dynamic suspension with McPherson front axle and twist-beam rear suspension

Tyre repair kit

### Audio and communication

6.5" display screen – manually retractable

AUX-IN socket

Concert radio/single CD player with MP3 file compatibility, 6 speakers in front and rear and 2 tweeters

SD memory card reader

### Seats

Driver and front passenger seats with manual height, forwards and backwards adjustment

Easy-entry front seats

Split folding rear seats

'Zeitgeist' cloth upholstery

### Safety and security

Driver, front passenger, front side and head airbag system

Front passenger airbag deactivation switch

ISOFIX child seat preparation for rear seats

Electronic Stability Programme (ESP), including ABS, EBD, ASR and EDL

First aid kit

Halogen headlights

Rear fog light

Rear head restraints (adjustable)

Seat belts – 3-point on all seats

Seat belt reminder for all seats

Thatcham Category 1 alarm and immobiliser

Remote central locking with 2 foldaway keys

Tool kit and car jack

Warning triangle

### Exterior equipment

Body-coloured door mirrors with integrated indicators

Electrically operated door mirrors

### Interior equipment

3-spoke Sports steering wheel

Steering wheel adjustable for height and reach

Air vent sleeves in matt black

Electric front windows

Heat-insulating glass windscreen and side windows

Front floor mats

Heated rear windscreen

Manual air conditioning

Non-smoking package

Washer fluid level indicator

Contrasting colour panels on doors, door armrest and centre console (see page 26)



15" x 6.5J '7-arm' design alloy wheels



Body-coloured door mirrors with integrated indicators

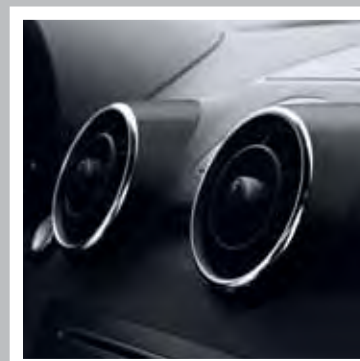

Air vent sleeves in matt black

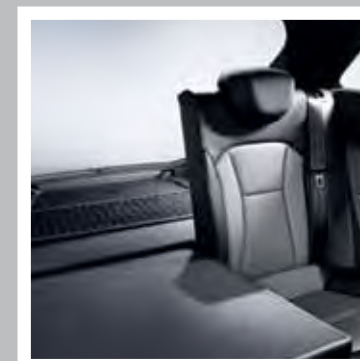

Split folding rear seats

# Sport model equipment

In addition to SE model equipment

<p><b>Basic RRP</b> £1,533.33</p> <hr/> <p><b>Total RRP inc VAT</b> £1,840.00</p>
---

### Wheels, tyres and suspension

16" x 7J '10-spoke' design alloy wheels with 215/45 R16 tyres

Sports suspension with stiffer spring and damper settings. Dynamic (SE) suspension is available in lieu of Sports suspension at no charge

### Audio and communication

Mobile phone preparation – Bluetooth interface

Voice control of key telephone and radio functions

### Seats

Front Sports seats

Manually adjustable lumbar support in front seats

'Tornado' cloth upholstery

### Exterior equipment

Front fog lights

Polished tailpipe(s)

### Interior equipment

3-spoke leather Sports multi-function steering wheel with aluminium inlay

Driver's Information System

Air vent sleeves in high gloss black

Aluminium trim for control switches, glove compartment, door handles and door sills

Leather handbrake grip and Sports gear knob with aluminium trim



16" x 7J '10-spoke' design alloy wheels



Front fog lights

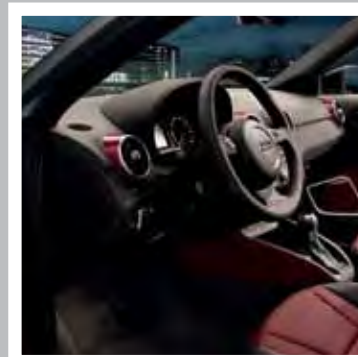

3-spoke leather Sports multi-function steering wheel



Air vent sleeves in high gloss black

# S line model equipment

## In addition to Sport model equipment

**Basic RRP**  
£1,287.50

**Total RRP inc VAT**  
£1,545.00

### Wheels, tyres and suspension

17" x 7.5J '5-twin-spoke' design alloy wheels with 215/40 R17 tyres

S line Sports suspension

### Seats

Black 'Sprint' cloth/leather upholstery with embossed S line logo in front seats

### Exterior equipment

S line badges on front wings

S line body styling, comprising radiator grille in high gloss black, front sports bumper, side skirts and rear bumper with diffuser

S line roof spoiler

### Interior equipment

3-spoke leather Sports multi-function steering wheel with aluminium inlay, S line badging and perforated leather trim

### Black cloth headlining

Door sills with aluminium inlays and S line lettering

**LED interior light package.** Includes illuminated door handles, footwell lighting, illuminated vanity mirrors, illuminated glovebox, front reading lights and ambient lighting of the centre console

**Centre console and door armrest in mono. pur.** Only available on 1.4 TFSI (185PS)



Door sills with aluminium inlays and S line lettering



Black 'Sprint' cloth/leather upholstery



17" x 7.5J '5-twin-spoke' design alloy wheels





# A1 Editions

## In addition to Sport model equipment

**Basic RRP**  
£1,500.00

**Total RRP inc VAT**  
£1,800.00

### Competition Line

Competition Line is inspired by famous models from Audi's motorsport heritage, such as the legendary Audi quattro rally car which delivered numerous world championships in the early 1980s. It combines aerodynamic body styling with a striking, motorsport-inspired design both inside and out.

### Wheels

18" x 7.5J '5-arm Polygon' design alloy wheels in matt black, with 225/35 R18 tyres

### Interior equipment

#### Interior styling package:

- Centre console trim
- Door handles
- Floor mats
- Rear-view mirror trim\*
- Air vent sleeves in high gloss white

### Exterior equipment

#### Exterior styling package:

- Front spoiler
- Double-blade roof spoiler
- Side skirts
- Rear diffuser in gloss black

#### Exterior design features on:

- Roofline
- Shoulder line with 'Audi Sport' lettering
- Number '1' on the bonnet and doors
- Boot lid
- Front spoiler lip, side skirts, wheel arch surrounds and double-blade roof spoiler
- Rear sills with Audi rings



Exterior design features



Competition Line interior styling

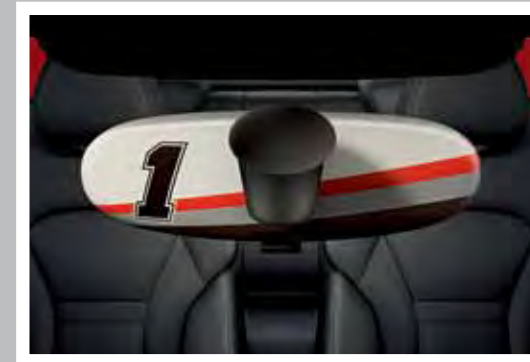

Rear-view mirror trim\*



## A1 SE

Engines	Power	Transmissions	CO <sub>2</sub> g/km	Basic RRP	Total RRP inc VAT	Recommended OTR
1.2 TFSI	86PS	5-speed manual	118	£10,645.83	£12,775.00	£13,420.00
1.6 TDI	105PS	5-speed manual	99	£11,529.17	£13,835.00	£14,480.00

## A1 Sport

Engines	Power	Transmissions	CO <sub>2</sub> g/km	Basic RRP	Total RRP inc VAT	Recommended OTR
1.2 TFSI	86PS	5-speed manual	118	£12,179.17	£14,615.00	£15,260.00
1.4 TFSI	122PS	6-speed manual	124	£12,520.83	£15,025.00	£15,670.00
1.4 TFSI	122PS	7-speed S tronic	119	£13,729.17	£16,475.00	£17,120.00
1.6 TDI	105PS	5-speed manual	99	£13,062.50	£15,675.00	£16,320.00

## A1 S line

Engines	Power	Transmissions	CO <sub>2</sub> g/km	Basic RRP	Total RRP inc VAT	Recommended OTR
1.2 TFSI	86PS	5-speed manual	118	£13,466.67	£16,160.00	£16,805.00
1.4 TFSI	122PS	6-speed manual	124	£13,808.33	£16,570.00	£17,215.00
1.4 TFSI	122PS	7-speed S tronic	122	£15,016.67	£18,020.00	£18,665.00
1.4 TFSI	185PS	7-speed S tronic	139	£16,625.00	£19,950.00	£20,710.00
1.6 TDI	105PS	5-speed manual	99	£14,350.00	£17,220.00	£17,865.00

For engine and model availability please speak to your Audi Centre.

**Please note:** The maximum power output figures are quoted in PS (or Pferdestärke, which is the metric equivalent of brake horsepower). To convert to brake horsepower, divide the PS figure by 1.0139.

**Recommended On-The-Road (OTR) retail prices include:** delivery charge, half a tank of fuel, number plates at £590.00 (inc. VAT), Road Fund Licence (which may vary depending on model/transmission – see page 56 for details) and first registration fee at £55.00. Vehicle Excise Duty correct at time of going to print, but this may alter to reflect any change in the applicable VED rate.

RRP – Recommended Retail Price. VAT is calculated at 20% but this may alter to reflect any change in the applicable VAT rate.

## A1 Competition Line

Engines	Power	Transmissions	CO <sub>2</sub> g/km	Basic RRP	Total RRP inc VAT	Recommended OTR
1.4 TFSI	122PS	6-speed manual	124	£14,020.83	£16,825.00	£17,470.00
1.4 TFSI	122PS	7-speed S tronic	119	£15,229.17	£18,275.00	£18,920.00
1.6 TDI	105PS	5-speed manual	99	£14,562.50	£17,475.00	£18,120.00



# Paint

You can select one of the standard colours shown opposite or, for a different look, choose from the range of optional gloss, metallic or pearl-effect finishes.

## Standard colours

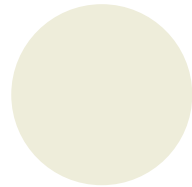

Amalfi white, gloss - Y5

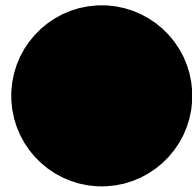

Brilliant black, gloss - A2

## Optional colours

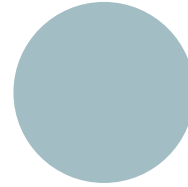

Cumulus blue, gloss - U4

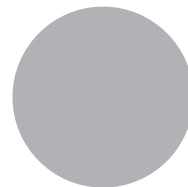

Ice silver, metallic - P5

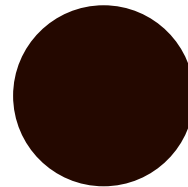

Teak brown, metallic\*\* - 4U

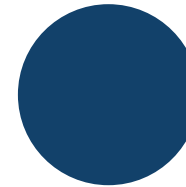

Scuba blue, metallic\*\* - S9

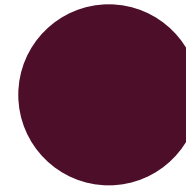

Shiraz red, metallic\*\* - 3A

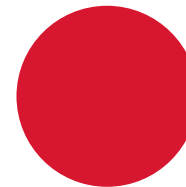

Misano red, pearl effect\*\* - N9

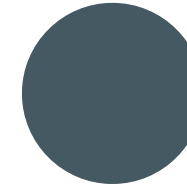

Sphere blue, metallic\*\* - 9F

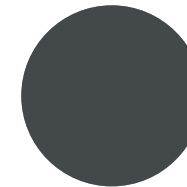

Daytona grey, pearl effect\* - 6Y

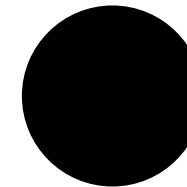

Phantom black, pearl effect - L8



Glacier white, metallic - 2Y

Options are subject to availability and may extend delivery.

All the colour swatches on this page are matched as accurately as possible to the actual paint colours used. However, due to print processes, Audi UK cannot guarantee that colours shown are 100% accurate.

Visit your local Audi Centre for a more accurate colour swatch.

\*S line colour only.

\*\*Not available on Competition Line

RRP - Recommended Retail Price.

VAT is calculated at 20% but this may alter to reflect any change in the applicable VAT rate.

**Cumulus blue optional colour**

**Basic RRP**  
£166.67

---

**Total RRP inc VAT**  
£200.00

**Other optional colours**

**Basic RRP**  
£425.00

---

**Total RRP inc VAT**  
£510.00



# Roof contrast line

Choose one of the optional roof contrast line colours opposite to complement your paint, enhancing the design of your A1.



Amalfi white, gloss - Y5

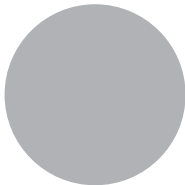

Ice silver, metallic - P5

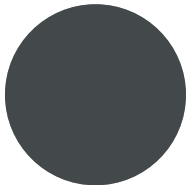

Daytona grey, pearl effect - 6Y

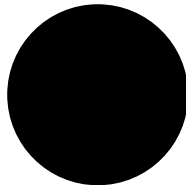

Brilliant black, gloss - A2

<b>Roof contrast line</b>
<b>Basic RRP</b> £291.67
<hr/>
<b>Total RRP inc VAT</b> £350.00



Roof contrast line is not available on Competition Line.

# Roof contrast line

## Paint and roof contrast line combinations

To help you choose the exterior design of your A1, please use this guide which shows possible paint and roof contrast line combinations.

Order Code		Amalfi white, gloss (Y5)	Ice silver, metallic (P5)	Daytona grey, pearl effect (6Y)	Brilliant black, gloss (A2)
Y5	Amalfi white, gloss	–	●	●	●
A2	Brilliant black, gloss	–	–	–	–
U4	Cumulus blue, gloss	●	●	●	–
P5	Ice silver, metallic	–	–	–	●
S9	Scuba blue, metallic	●	●	●	–
3A	Shiraz red, metallic	●	●	●	●
9F	Sphere blue, metallic	●	●	–	●
4U	Teak brown, metallic	●	●	–	–
2Y	Glacier white, metallic	–	●	●	●
L8	Phantom black, pearl effect	●	●	●	–
6Y	Daytona grey, pearl effect	–	●	–	–
N9	Misano red, pearl effect	●	●	–	●

Options are subject to availability and may extend delivery.

- = Not available
- = Available
- S = Standard





# Upholstery

## A1 SE models

Your chosen upholstery will be complemented with a contrasting centre console, door armrest and door panels including speaker housings. When black upholstery is chosen, these panels will be trimmed in black.

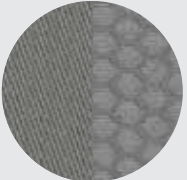
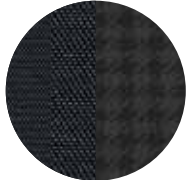
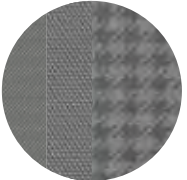
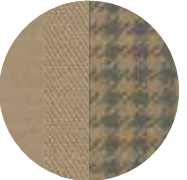
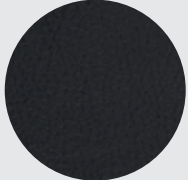
Air vent sleeves are also available to complement your upholstery colour – see page 38 for more details.

	SE	Sport	S line	Competition Line	Basic RRP	Total RRP inc VAT
<b>Zeitgeist cloth</b>  	S	-	-	-	No charge	No charge
<b>Style cloth</b>    <p>Only available in combination with Media Style package – see page 34 for further details</p>	P	-	-	-	No charge	No charge
<b>Milano leather</b>    <p>Only available in combination with Media Style package – see page 34 for further details</p>	P	-	-	-	£1,020.83	£1,225.00

Options are subject to availability and may extend delivery.

- = Not available
- = Available
- S = Standard
- P = Available as part of a package – see page 34 for details

RRP – Recommended Retail Price.

VAT is calculated at 20% but this may alter to reflect any change in the applicable VAT rate.



Black Zeitgeist cloth – YM



Black/Titanium grey Tornado cloth – FK



Velvet beige Style cloth – YQ

# Upholstery

## A1 Sport models/ A1 Editions

Choose your favourite upholstery from the swatches shown opposite to give your car's interior the look and feel you want.

All Sport model upholstery colours receive contrast colour seat stitching.

## A1 S line models



Options are subject to availability and may extend delivery.

- = Not available
- = Available
- S = Standard
- P = Available as part of a package
- see page 34 for details

\*Not available on Competition Line.

RRP - Recommended Retail Price.

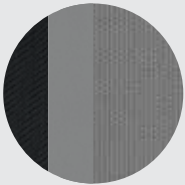
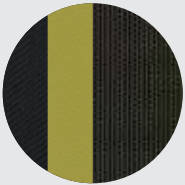
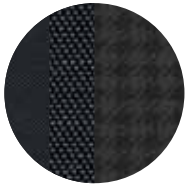
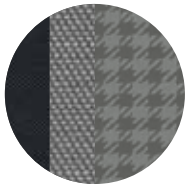
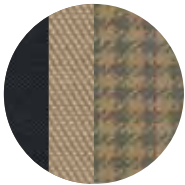
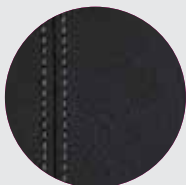
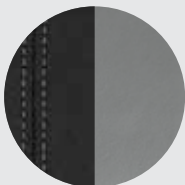
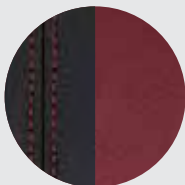
VAT is calculated at 20% but this may alter to reflect any change in the applicable VAT rate.

					SE	Sport	S line	Competition Line	Basic RRP	Total RRP inc VAT
Tornado cloth					-	S	-	S	No charge	No charge
	Black - YS	Black/Titanium grey - FK*	Black/Wasabi green - YP*							
	Style cloth					-	P	-	-	No charge
Black/Black - YS		Black/Titanium grey - FK	Black/Velvet beige - YR	Only available in combination with Media Style package - see page 34 for further details						
Milano leather						-	•	-	•	£1,020.83
	Black/Black - YS	Black/Titanium grey - FK*	Black/Red - YN*							
	Sprint cloth/leather					-	-	S	-	No charge
Black - QZ										
Silk Nappa leather					-	-	•	-	£916.67	£1,100.00
	Black - QZ		Only in combination with Super Sports seats (Q4Q) - see page 48 for further details							

## Audi exclusive



Every Audi is intrinsically exclusive.  
It's the breathtaking design, the exceptional  
engineering, the Vorsprung durch Technik.  
But for that special touch you can specify  
your new A1 with options from Audi exclusive.  
It means that you'll be able to drive the car  
you've always imagined.

Both the exclusive and standard options can  
be found on the following pages.



# Upholstery

## Audi exclusive

With Audi exclusive, you can specify your seats in Fine Nappa leather in an array of different colours shown to the right.

Select just one all-over shade for each seat, or customise each panel in two or more complementary colours from the distinctive Audi exclusive palette. You can even choose the colour of the decorative stitching – to match or contrast with your chosen upholstery – from this varied collection. Whatever combination you decide upon, we think you'll be extremely comfortable with the result.



Chestnut brown

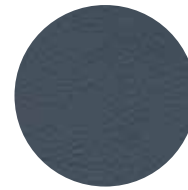

Jet grey



Alabaster white

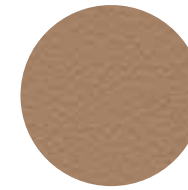

Sand beige

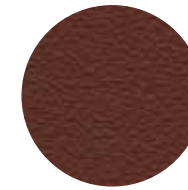

Saddle brown

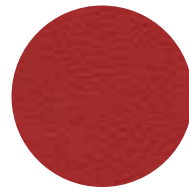

Crimson red



Magnolia white



Havanna brown

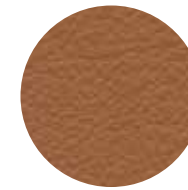

Cognac brown

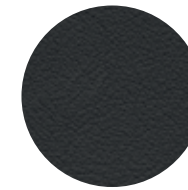

Night blue

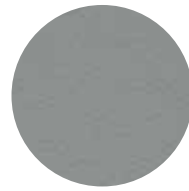

Cloudy grey

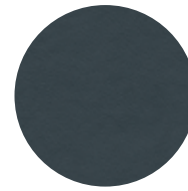

Smoky blue

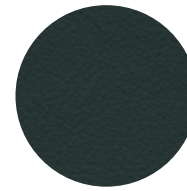

Iceland green

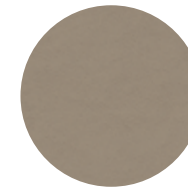

Powder beige

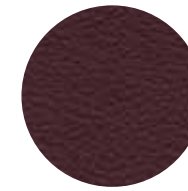

Classic red

# Upholstery

## Audi exclusive

Order Code		SE	Sport	S line	Competition Line	Basic RRP	Total RRP inc VAT
PYA S3G	<b>Audi exclusive leather package 1 in Fine Nappa leather with Sports seats.</b> Includes leather-covered seat upholstery, door trim inserts and floor mats with leather piping. Backrest covers and seat add-on parts come in the interior trim colour*	-	●	-	-	£2,108.33	£2,530.00
		-	-	●	-	£1,691.67	£2,030.00
YS1 7HB S3G	<b>Audi exclusive extended leather.</b> Lower centre console and door armrests in Audi exclusive leather	-	●	●	-	£925.00	£1,110.00

Options are subject to availability and may extend delivery.

- = Not available
- = Available
- S = Standard

\*Leather, stitching and piping (where applicable) colours can be specified in a variety of colours from the Audi exclusive range.

RRP – Recommended Retail Price.

VAT is calculated at 20% but this may alter to reflect any change in the applicable VAT rate.

# Upholstery

## Audi exclusive line

Audi exclusive is ultimately about choice – but if you'd rather leave some of the decisions in the capable hands of our designers, the expert team at quattro GmbH have compiled Audi exclusive line, combining some of the most popular elements of the exclusive range in one, beautifully coordinated package.

Options are subject to availability and may extend delivery.

– = Not available  
 ● = Available  
 S = Standard

RRP – Recommended Retail Price.

VAT is calculated at 20% but this may alter to reflect any change in the applicable VAT rate.

Order Code		SE	Sport	S line	Competition Line	Basic RRP	Total RRP inc VAT
<b>WQK</b>	<b>Audi exclusive line.</b> Only in conjunction with LED interior light package (QQ1)		●			£1,333.33	£1,600.00

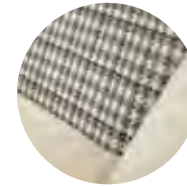

Alabaster white/Jet grey (UG)

### This package includes

- ▶ Sports seats with Jet grey Fine Nappa leather seat side sections. Seat centre section in Style cloth with Sports stripes in Alabaster white Alcantara and contrasting stitching in Alabaster white
- ▶ Black cloth headlining
- ▶ Air vents in high-gloss black
- ▶ Floor mats in black with piping in Jet grey
- ▶ Lower centre console in Jet grey mono.pur with contrasting stitching in Alabaster white
- ▶ Steering wheel rim and gear-lever gaiter come in interior trim colour with contrasting Alabaster white stitching







## Media Style package

This package provides a distinctive look and feel for your car's cabin, enabling you to integrate the audio system with your digital music player and stay in touch using Bluetooth technology.

You can also upgrade to a leather interior and choose contrasting air vent sleeve colours – see page 38.

Options are subject to availability and may extend delivery.

-- = Not available  
 ● = Available  
 S = Standard

\*Navigation function and map data is available as a retrofit solution from Audi Genuine Accessories. Please contact your Audi Centre for full details.

RRP – Recommended Retail Price.

VAT is calculated at 20% but this may alter to reflect any change in the applicable VAT rate.

Order Code		SE	Sport	S line	Competition Line	Basic RRP	Total RRP inc VAT
WMS 1XW	<b>Media Style package:</b> Includes Audi Music Interface, Bluetooth interface, Driver's Information System, leather multi-function steering wheel and LED interior light package. Also includes Style cloth upholstery, air vent sleeves in high gloss black, white or contrasting colour to your interior. Centre console, door armrest, door panels and speaker housings in contrasting mono.pur. Also including additional SD card reader and preparation for Satellite Navigation.* Not available in combination with Competition Line interior styling package or Connectivity package	●	–	–	–	£1,137.50	£1,365.00
		–	●	–	–	£450.00	£540.00

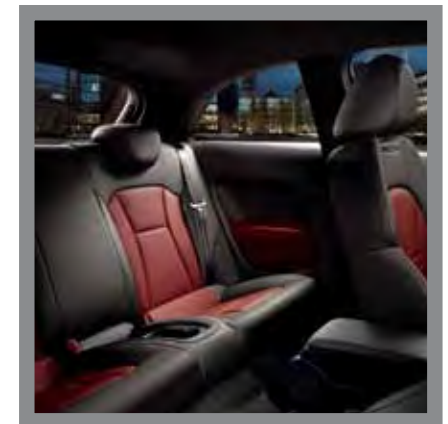
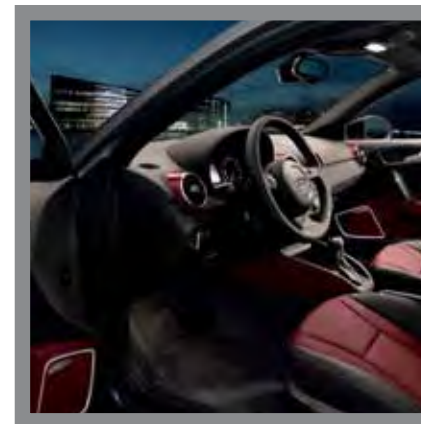
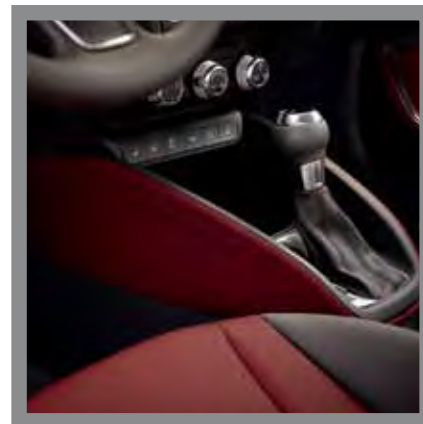

Media Style package with optional Milano leather in black/red – YN



# Colour and trim guide

## Interior trim colours

### SE models

To help you choose the right interior for your new Audi A1, please use this guide, showing the carpet, dashboard and headlining colours that have been matched to your chosen upholstery.

Order Code	Seat centre section	Seat side section	Contrast stitching	Dashboard	Carpet	Centre console, armrest, map pocket, speaker grilles	Headlining	Zeitgeist cloth (N0L)	Media Style package	
									Style cloth (N2D)	Milano leather (N5W)
<b>YM</b>	Black	Black	—	Black	Black	Black	Titanium grey	●	●	●
<b>FH</b>	Titanium grey	Titanium grey	—	Black	Titanium grey	Titanium grey	Titanium grey	●	●	●
<b>YQ</b>	Velvet beige	Velvet beige	—	Black	Black	Velvet beige	Titanium grey	—	●	●

### Sport models/ A1 Editions

Order Code	Seat centre section	Seat side section	Contrast stitching	Dashboard	Carpet	Centre console, armrest, map pocket, speaker grilles	Headlining	Tornado cloth (N2T)	Milano leather (N5W)	Media Style package	
										Style cloth (N2D)	Milano leather (N5W)
<b>YS</b>	Black	Black	Grey	Black	Black	Black	Titanium grey	●	●	●	●
<b>FK*</b>	Titanium grey	Black	Titanium grey	Black	Black	Titanium grey	Titanium grey	●	●	●	●
<b>YP*</b>	Wasabi green	Black	Wasabi green	Black	Black	Wasabi green	Titanium grey	●	—	—	—
<b>YN*</b>	Red	Black	Red	Black	Black	Red	Titanium grey	—	●	—	●
<b>YR*</b>	Velvet beige	Black	Velvet beige	Black	Black	Velvet beige	Titanium grey	—	—	●	—

### S line models

Order Code	Seat centre section	Seat side section	Contrast stitching	Dashboard	Carpet	Centre console, armrest, map pocket, speaker grilles	Headlining	Sprint cloth/leather (N7V)	Silk Nappa leather (N0R)

Options are subject to availability and may extend delivery.

- = Not available
- = Available
- S = Standard

\*Not available on Competition Line.



Tornado cloth, Black/Wasabi green (YP)

# Air vent sleeves

Choose an air vent sleeve to complement or contrast with your chosen interior colour.

## Matt finish



Matt black – 5MA

## High gloss finish



Black – 5MB



Titanium grey – 5MC



White – 5MJ

## Metallic finish



Aluminium look – 5MD\*



Velvet beige – 5MQ



Red – 5ML



Wasabi green – 5MN

Options are subject to availability and may extend delivery.

\*Only available on S line models.

– = Not available  
• = Available  
S = Standard

RRP – Recommended Retail Price.

VAT is calculated at 20% but this may alter to reflect any change in the applicable VAT rate.

# Air vent sleeves

Order Code		SE	Sport	S line	Competition Line	Basic RRP	Total RRP inc VAT
<b>SMA</b>	<b>Matt black</b>	S	-	-	-	No charge	No charge
<b>SMB</b>	<b>High gloss black</b>	●	S	S	-	£83.33	£100.00
<b>SMD</b>	<b>Aluminium look</b>	-	-	●	-	£83.33	£100.00
-	<b>High gloss colour contrast.</b> Available in 5 colours. See opposite page for colour availability. Please note that colour contrast air vent sleeves can be selected to complement corresponding interior colour or contrast with black upholstery	●	●	-	-	£83.33	£100.00
	In combination with Media Style package	S	S	-	-	No charge	No charge

Options are subject to availability and may extend delivery.

- = Not available
- = Available
- S = Standard

RRP - Recommended Retail Price.

VAT is calculated at 20% but this may alter to reflect any change in the applicable VAT rate.

## Wheels, tyres and suspension

Choose a set of specially-selected alloy wheels to subtly enhance the way your A1 looks.



15" x 6.5J '6-hole' design  
bi-colour alloy wheels - CSL



16" x 7J '7-arm dynamic'  
design alloy wheels - CQ3



17" x 7.5J '5-arm'  
design bi-colour alloy wheels - CP2



17" x 7.5J '5-V-spoke' design  
bi-colour alloy wheels - CP3



18" x 7.5J '7-twin-spoke'  
design alloy wheels - C6I

# Wheels, tyres and suspension

Order Code		SE	Sport	S line	Competition Line	Basic RRP	Total RRP inc VAT
C5L	15" x 6.5J '6-hole' design bi-colour alloy wheels with 205/55 R15 tyres	●	–	–	–	£129.17	£155.00
CQ3	16" x 7J '7-arm dynamic' design alloy wheels with 215/45 R16 tyres	–	●	–	–	£129.17	£155.00
CP2	17" x 7.5J '5-arm' design bi-colour alloy wheels with 215/40 R17 tyres	–	●	–	–	£383.33	£460.00
CP3	17" x 7.5J '5-V-spoke' design bi-colour alloy wheels with 215/40 R17 tyres	–	●	–	–	£466.67	£560.00
C6I	18" x 7.5J '7-twin-spoke' design alloy wheels with 225/35 R18 tyres	–	–	●	–	£341.67	£410.00
UC0	Dynamic suspension. McPherson front axle and twist-beam rear suspension	S	●	–	●	No charge	No charge

Options are subject to availability and may extend delivery.

– = Not available  
● = Available  
S = Standard

RRP – Recommended Retail Price.

VAT is calculated at 20% but this may alter to reflect any change in the applicable VAT rate.



# Packages

Some items work well together, which is why we've created these special packages. They provide increased convenience and value by combining several of our most popular options.

Options are subject to availability and may extend delivery.

- = Not available
- = Available
- S = Standard

RRP - Recommended Retail Price.

VAT is calculated at 20% but this may alter to reflect any change in the applicable VAT rate.

Order Code		SE	Sport	S line	Competition Line	Basic RRP	Total RRP inc VAT
<b>WBI</b>	<b>Comfort package.</b> Acoustic parking system (rear only), cruise control, auto-dimming rear-view mirror and light and rain sensors	•	•	•	•	£504.17	£605.00
<b>PNQ</b>	<b>Technology package.</b> Satellite Navigation system - HDD-based with Audi Music Interface. Route planning and guidance using voice, pictogram and 3D mapping. 7-digit postcode recognition. Includes AM/FM tuner with TP memo function. Single front-loading CD/DVD player with MP3 compatibility, suitable for audio and DVD playback. Third generation MMI system including high resolution (800x480) 6.5" colour TFT display, two SD card readers and 40GB hard drive, 20GB of which can be used to store up to 8,000 songs. HDD Navigation functionality includes advanced speech recognition, 3D and topographical mapping display and advanced 3D building display	-	•	•	•	£1,145.83	£1,375.00
	In combination with Media Style package	-	•	-	-	£1,020.83	£1,225.00
<b>XE1</b>	<b>Xenon light package.</b> Includes Xenon Plus headlights with headlight washers (PX4), LED interior light package (QQ1) and light and rain sensors (8N6/4GP). Not available in combination with Comfort package or on 1.4 TFSI Sport S tronic	•	•	-	•	£912.50	£1,095.00
	In combination with Media Style package	•	•	-	-	£795.83	£955.00
<b>XE2</b>	<b>Xenon light package.</b> Includes Xenon Plus headlights (PX5), LED interior light package (QQ1) and light and rain sensors (8N6/4GP). Only available on 1.4 TFSI Sport S tronic. Not available in combination with Comfort package	-	•	-	•	£829.17	£995.00
	In combination with Media Style package	-	•	-	-	£712.50	£855.00



3-spoke leather Sports multi-function steering wheel



Satellite Navigation - HDD-based



# Audio and communication

Stay in touch using our range of communication functions, and give each journey its own soundtrack with our advanced audio equipment.

You can also opt for the technology package, which combines some of the features shown here with the Satellite Navigation system – HDD-based. See page 42 for further details.

Options are subject to availability and may extend delivery.

– = Not available  
• = Available  
S = Standard

\*When combined with technology package.  
\*\*Navigation function and map data is available as a retrofit solution from Audi Genuine Accessories. Please contact your Audi Centre for full details.

RRP – Recommended Retail Price.

VAT is calculated at 20% but this may alter to reflect any change in the applicable VAT rate.

Order Code		SE	Sport	S line	Competition Line	Basic RRP	Total RRP inc VAT
9Q7	<b>Driver's Information System (DIS)</b>	•	S	S	S	£158.33	£190.00
9V3	<b>DAB digital radio.</b> Integrated into MMI, receives digitally-transmitted radio stations in addition to the range of analogue stations. Displays music track, artist and radio program. Capable of 'DAB Slideshow' where transmitted. Reception dependent on local digital network. Automatic switch from DAB to FM reception if the network signal is not strong enough. Only in combination with mobile telephone preparation, Driver's Information System (DIS), multi-function steering wheel and upgraded sound system or Satellite Navigation system	•	•	•	•	£254.17	£305.00
9VD	<b>Audi sound system.</b> Includes 6-channel amplifier, 6 loudspeakers in front and rear, 2 tweeters in A-posts, centre speaker in dashboard and subwoofer. Total output of 180 Watts	•	•	•	•	£212.50	£255.00
9VK	<b>BOSE® surround sound system.</b> 5.1 surround sound* with dynamic noise-compensation, 10-channel amplifier, 14 loudspeakers including centre speaker in the dashboard and 2 surround loudspeakers in the rear shelf. Total output of 465 Watts. Speaker housings with bevelled edge plus lighting for door speakers (only available in combination with LED interior light package). Please note luggage capacity is reduced with this option	•	•	•	•	£575.00	£690.00
PNU	<b>Satellite Navigation system – SD card-based.</b> Route planning and guidance using voice, pictogram and 2D mapping. 7-digit postcode recognition. Includes AM/FM tuner with TP memo function. Single front-loading CD player with MP3 compatibility. Third generation MMI system including high resolution (400x240) 6.5" colour TFT display and two SD card readers (one of which is used by the Navigation SD card). Navigation functionality includes advanced speech recognition. Also includes Audi Music Interface and Bluetooth interface with Bluetooth audio streaming. Only in combination with Driver's Information System and multi-function steering wheel. Not in combination with Connectivity package	•	–	–	–	£979.17	£1,175.00
		–	•	•	•	£729.17	£875.00
PNV	<b>Connectivity package.</b> Audi Music Interface, Bluetooth interface including voice control and Bluetooth audio streaming. Also includes additional SD card reader and preparation for Satellite Navigation.** Only in combination with Driver's Information System and multi-function steering wheel. Not in combination with Media Style package, technology package or Satellite Navigation – SD card-based	•	–	–	–	£504.17	£605.00
		–	•	•	•	£254.17	£305.00

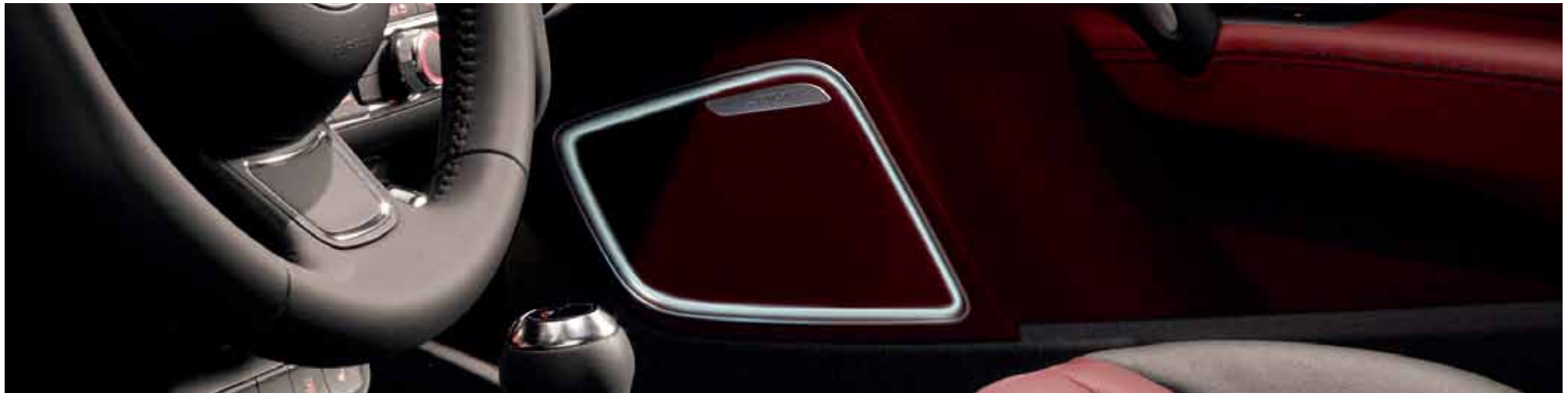

BOSE® surround sound system

# Audio and communication

\*Online services are only available for mobile phone contracts including a data option and only within the coverage of the mobile phone network; there may be additional costs for the use of these services (charges and billing correspond to the personal mobile phone contract). Due to high data volumes, a mobile phone contract including a data flat rate is strongly recommended. The content and scope of the online-based services offered may vary.

Options are subject to availability and may extend delivery.

- = Not available  
 • = Available  
 S = Standard

RRP – Recommended Retail Price.

VAT is calculated at 20% but this may alter to reflect any change in the applicable VAT rate.

Order Code		SE	Sport	S line	Competition Line	Basic RRP	Total RRP inc VAT
<b>9ZX</b>	<b>Mobile telephone preparation – Bluetooth interface.</b> Provides handsfree connection via Bluetooth using mobile phone aerial. Please contact your Audi Centre for phone compatibility. Only in combination with Driver's Information System and multi-function steering wheel	•	S	S	S	£250.00	£300.00
<b>9ZF</b>	<b>Mobile telephone preparation – Low with Bluetooth.</b> Provides handsfree connection via Bluetooth using mobile phone aerial. Alternatively, it can use a cradle with charging facility for optimal reception via external aerial. Cradle available at extra cost – please contact your Audi Centre for phone compatibility. Includes front centre armrest. Only in combination with Driver's Information System and multi-function steering wheel	•	-	-	-	£508.33	£610.00
<b>6E3</b>		-	•	•	•	£254.17	£305.00
<b>9ZW</b>	<b>Mobile telephone preparation – High with online services.</b> A Bluetooth-capable mobile phone can be conveniently connected to the internal UMTS module (provided the mobile telephone has a SIM Access profile). An additional SIM card reader is located in the surround of the MMI Navigation Plus. It's possible to transfer phone book entries to the vehicle and manage call lists. Includes online services such as point of interest search, navigation using Google Earth images, destination entry, information services, e.g. weather and Wi-Fi hotspot for convenient internet access using a mobile device (e.g.laptop).* The system is simply operated via the MMI Navigation Plus, a multi-function leather steering wheel or the speech dialogue system. Only in combination with technology package (PNQ)	-	•	•	•	£600.00	£720.00
<b>7A2</b>	<b>CD changer.</b> For six CDs with MP3 compatibility	•	•	•	•	£320.83	£385.00



Mobile telephone preparation – Low with Bluetooth

# Steering wheels

You can choose from a selection of advanced leather multi-function steering wheels, allowing you to control your audio system at the touch of a button.

Order Code		SE	Sport	S line	Competition Line	Basic RRP	Total RRP inc VAT
<b>2PV</b>	<b>3-spoke leather Sports steering wheel</b>	●	—	—	—	£137.17	£165.00
<b>1XW</b>	<b>3-spoke leather Sports multi-function steering wheel.</b> Only in combination with Driver's Information System	●	S	S	S	£266.67	£320.00
<b>1XX</b>	<b>3-spoke leather Sports multi-function steering wheel</b> with gear-shift paddles (S tronic models only)	—	●	●	●	£79.17	£95.00
<b>YRB S3G</b>	<b>Audi exclusive controls package.*</b> Includes leather-covered steering wheel rim, handbrake grip and gear-shift gaiter. Only available in conjunction with 3-spoke leather Sports multi-function steering wheel (1XW) or 3-spoke leather Sports steering wheel (2PV). Not available in conjunction with Audi exclusive leather-covered steering wheel rim (YRH/S3G)	●	●	●	●	£512.50	£615.00
<b>YRH S3G</b>	<b>Audi exclusive leather-covered steering wheel rim.*</b> Only available in conjunction with 3-spoke leather Sports multi-function steering wheel (1XW) or 3-spoke leather Sports steering wheel (2PV). Not available in conjunction with Audi exclusive Controls package (YRB/S3G)	●	●	●	●	£304.17	£365.00

# Safety and security

Intelligent technology designed to give you better all-round awareness and safety on the road.

<b>7X1</b>	<b>Acoustic parking system (rear only).</b> Aids parking by acoustically indicating distances to obstacles. Also available as part of the Comfort package – see page 42 for details	●	●	●	●	£254.17	£305.00
<b>7X4</b>	<b>Audi parking system plus (front and rear).</b> Aids parking by acoustically and visually indicating distances to obstacles	●	●	●	●	£445.83	£535.00
<b>8WB</b>	<b>Front fog lights</b>	●	S	S	S	£116.67	£140.00
<b>7K6</b>	<b>Tyre pressure loss indicator.</b> A visual and acoustic warning when the system detects a potential loss of tyre pressure	●	●	●	●	£45.83	£55.00
<b>UG4</b>	<b>Audi hill-hold assist.</b> Prevents roll-back on hills for up to 5 seconds by maintaining brake force (standard with S tronic transmission)	●	●	●	●	£54.17	£65.00

Options are subject to availability and may extend delivery.

— = Not available  
● = Available  
S = Standard

\*Leather and stitching (where applicable) can be selected from any of the Audi exclusive colours shown on page 30.

RRP – Recommended Retail Price.

VAT is calculated at 20% but this may alter to reflect any change in the applicable VAT rate.

# Exterior equipment

Make sure your car looks exactly as you want it to by selecting some of our striking options.

Options are subject to availability and may extend delivery.

- = Not available  
• = Available  
S = Standard

RRP – Recommended Retail Price.

VAT is calculated at 20% but this may alter to reflect any change in the applicable VAT rate.

Order Code		SE	Sport	S line	Competition Line	Basic RRP	Total RRP inc VAT
PAF	<b>Door mirrors – heated and folding.</b> Includes heated washer nozzles	•	•	•	•	£187.50	£225.00
PX4	<b>Xenon Plus headlights.</b> Includes LED daytime-running lights, rear LED lights, automatic headlight adjustment, dynamic range control and headlight washers	-	-	•	-	£637.50	£765.00
3FB	<b>Open sky panoramic sunroof.</b> Comprising glass roof with electric slide-and-tilt control and sunshade at front and rear. Also includes convenience closing from outside via the central locking system. Only in combination with LED interior light package. Not available on 1.4 TFSI Sport S tronic	•	•	•	•	£745.83	£895.00
2Z0	<b>Deletion of model and engine technology designation at rear</b>	•	•	•	•	No charge	No charge
2Z7	<b>Deletion of engine technology designation at rear</b>	•	•	•	•	No charge	No charge
4ZM	<b>Black styling package.</b> Radiator grille-frame in highly polished black, with radiator grille, number plate holder and fog light surrounds in matt black. On S line models the air inlet blade and diffuser insert are in platinum grey	•	•	•	•	£295.83	£355.00
4KF	<b>Privacy glass.</b> Dark tinted glass from B pillar backwards	•	•	•	•	£329.17	£395.00
1D7	<b>Tow-bar preparation.</b> Please consult your local Audi Centre for full details on complete tow-bar fitting costs. Only in combination with luggage package. Not available on 1.4 TFSI S tronic (185PS)	•	•	•	•	£91.67	£110.00
YNE CP2 YNH	<b>Aerodynamic exterior styling package.</b> Includes front spoiler, double-blade roof spoiler, side skirts, rear diffuser in gloss black, stainless steel tailpipe trims and 17" '5-arm' design alloy wheels	-	•	-	-	£1,658.33	£1,990.00
YNH	<b>Double-blade roof spoiler</b>	-	•	-	S	£337.50	£405.00



Xenon Plus headlights with LED daytime-running lights



LED rear lights (included with Xenon Plus headlights)

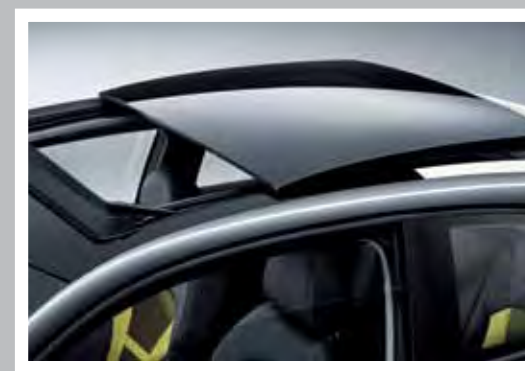

Open sky panoramic sunroof

# Interior equipment

Specify every detail of your car's interior with this wide range of options.

Order Code		SE	Sport	S line	Competition Line	Basic RRP	Total RRP inc VAT
<b>4F2</b>	<b>Advanced key.</b> Access and authorisation system which automatically exchanges data between key and vehicle, allowing the driver to keep the key in their pocket or bag at all times. To unlock and open, simply lift the driver door handle. To lock, press the button on the handle. Pressing the start/stop button integrated in the centre console starts and stops the engine	●	●	●	●	£250.00	£300.00
<b>6Q6</b>	<b>Aluminium gear knob.</b> Only on manual models	●	●	●	—	£108.33	£130.00
<b>8T2</b>	<b>Cruise control.</b> For holding any speed above 25mph. Also available as part of the Comfort package – see page 42 for details	●	●	●	●	£195.83	£235.00
<b>9AK</b> <b>8N6</b> <b>4GP</b>	<b>Electronic climate control.</b> Automatically controls the air temperature, flow rate, distribution and air recirculation, including humidity sensor and defrost button for rapid defrosting of windscreen. Also includes light and rain sensors	●	●	●	●	£275.00	£330.00
	In combination with Comfort package or Xenon light package	●	●	●	●	£170.83	£205.00
<b>Q4Q</b>	<b>Super Sports seats.</b> With integrated headrests and shaped side bolsters giving increased lateral support. Easy-entry front seats with 2-way lumbar support. Manually adjustable height, forwards and backwards position, headrest and seat back angle. Only in combination with Silk Nappa leather (NÖR)	—	—	●	—	£500.00	£600.00
<b>4A3</b>	<b>Heated front seats.</b> Individually controlled variable temperature adjustment	●	●	●	●	£212.50	£255.00
<b>QQ1</b>	<b>LED interior light package.</b> Includes illuminated door handles, footwell lighting, illuminated vanity mirrors, illuminated glovebox, front reading lights and ambient lighting of the centre console	●	●	S	●	£116.67	£140.00
<b>8N6</b> <b>4GP</b>	<b>Light and rain sensors.</b> Automatic headlight activation, automatic windscreen wipers, coming home/leaving home function and sun band for windscreen	●	●	●	●	£104.17	£125.00
<b>4L6</b> <b>8N6</b> <b>4GP</b>	<b>Auto-dimming rear-view mirror.</b> Includes light and rain sensors	●	●	●	●	£204.17	£245.00
	In combination with electronic climate control or Xenon light package	●	●	●	●	£100.00	£120.00
<b>8N7</b> <b>4L6</b> <b>4GP</b>	<b>High-beam assist.</b> Automatically adjusts headlights from high-beam to dipped-beam when another vehicle is approaching. Includes auto-dimming rear-view mirror and light and rain sensors. Only in combination with Driver's Information System	●	●	●	●	£287.50	£345.00
	In combination with Comfort package	●	●	●	●	£83.33	£100.00
	In combination with Xenon light package	●	●	●	●	£183.33	£220.00

Options are subject to availability and may extend delivery.

— = Not available  
● = Available  
S = Standard

RRP – Recommended Retail Price.

VAT is calculated at 20% but this may alter to reflect any change in the applicable VAT rate.

# Interior equipment

Order Code		SE	Sport	S line	Competition Line	Basic RRP	Total RRP inc VAT
QE4	<b>Luggage package.</b> Comprising combi-net for fixing into luggage compartment, 12V socket, additional light within luggage compartment, bag hooks, tensioning strap and storage compartment under load floor	●	●	●	●	£79.17	£95.00
QE1	<b>Storage package.</b> Storage compartment under front passenger seat, net on side of centre console, bag hooks on left and right in rear passenger compartment, lockable glove compartment and storage tray with 3 cupholders between rear passenger seats	●	●	●	●	£91.67	£110.00
6NQ	<b>Cloth headlining – Black.</b> Only in combination with LED interior light package	●	●	S	●	£137.50	£165.00
6E3	<b>Front centre armrest</b> with storage compartment	●	●	●	●	£104.17	£125.00
0TD	<b>Rear floor mats</b>	●	●	●	●	£37.50	£45.00
9JD	<b>Smoker's package.</b> Includes ashtray and cigarette lighter. Replaces storage compartment and 12V socket	●	●	●	●	£12.50	£15.00
YIA	<b>Interior styling package.</b> Includes Competition Line design floor mats, door handles, centre console trim and rear-view mirror trim. Also includes air vent sleeves in high gloss white. Not available in combination with Media Style package. Only in combination with black upholstery. Rear-view mirror trim not available in combination with auto-dimming rear-view mirror	–	●	–	S	£362.50	£435.00

Options are subject to availability and may extend delivery.

- = Not available
- = Available
- S = Standard

RRP – Recommended Retail Price.

VAT is calculated at 20% but this may alter to reflect any change in the applicable VAT rate.



Electronic climate control

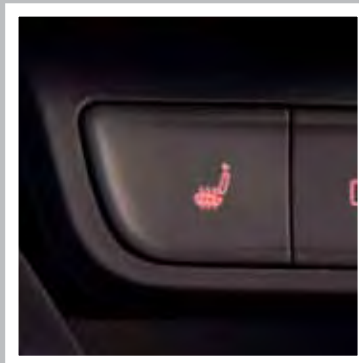

Heated front seats

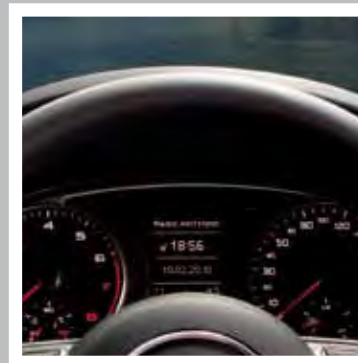

Driver's Information System (DIS)

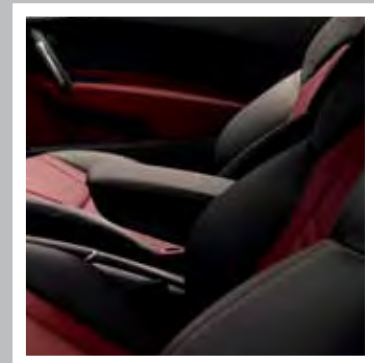

Front centre armrest



## Service Plan

Choosing an Audi Service Plan provides an easy way to cover all your car's scheduled servicing with a one-off payment. It can take care of everything from fluid and filter changes to your full service, ensuring you retain a full Audi service history. There are no servicing bills to plan for and you'll continue to benefit from today's prices for the length of your agreement.

\* For further details on Service Schedules please see page 56

Order Code		SE	Sport	S line	Competition Line	Basic RRP	Total RRP inc VAT
-	<b>Audi Service Plan - Longlife Service Schedule*</b> . Comprehensive package covering servicing costs for 5 years or 50,000 miles, whichever comes sooner. Your A1 should be placed on the Longlife Service Schedule if you drive over 10,000 miles per annum. Visit <a href="http://audi.co.uk">audi.co.uk</a> or your local Audi Centre for full details, including terms and conditions. For retail customers only	●	●	●	●	£208.33	£250.00
-	<b>Audi Service Plan - Fixed Inspection Service Schedule*</b> . Comprehensive package covering servicing costs for 5 years or 50,000 miles, whichever comes sooner. Your A1 should be placed on the Fixed Inspection Service Schedule if you drive under 10,000 miles per annum. Visit <a href="http://audi.co.uk">audi.co.uk</a> or your local Audi Centre for full details, including terms and conditions. For retail customers only	●	●	●	●	£375.00	£450.00

Please ask at your Audi Centre or visit [audi.co.uk/audicomplete](http://audi.co.uk/audicomplete) to find out about Audi Complete, an alternative plan including maintenance and tyres.

## Warranty

Order Code		SE	Sport	S line	Competition Line	Basic RRP	Total RRP inc VAT
-	<b>Audi Warranty</b> , covering you for unlimited mileage in the first 2 years of ownership, and up to 60,000 miles in the third year. Transferable between owners**	S	S	S	S	No charge	No charge
EA6	<b>Audi Warranty</b> , covering you for up to 4 years or 75,000 miles, whichever comes soonest. Cover includes a 2-year unlimited mileage warranty, and up to 75,000 miles in the third and fourth years. Transferable between owners**	●	●	●	●	£195.83	£235.00
EA9	<b>Audi Warranty</b> , covering you for up to 5 years or 90,000 miles, whichever comes soonest. Cover includes a 2-year unlimited mileage warranty, and up to 90,000 miles in the third, fourth and fifth years. Transferable between owners**	●	●	●	●	£416.67	£500.00

\*\*Only available prior to registration of your Audi A1. Speak to your Audi Centre for full details.

Options are subject to availability and may extend delivery.

- = Not available  
● = Available  
S = Standard

RRP - Recommended Retail Price.

VAT is calculated at 20% but this may alter to reflect any change in the applicable VAT rate.

# Merchandise

From the enthusiasts' motorsport collection to the sophisticated Audi collection, there's a wide variety of adults' and children's clothing, lifestyle accessories and collectables, all of which bear the Audi name.

Please speak to a member of our team at your local Audi Centre to see the full Audi collection and to place an order. A selection of Audi merchandise is also available to buy from [audi.co.uk/merchandise](http://audi.co.uk/merchandise).



Audi kids



Bags and leather goods



Clothing



Motorsports



Sport and travel



Model cars

# Accessories

Choosing an Audi isn't just a matter of deciding on the model you want; it's about creating a car that suits your needs perfectly. And that's why we've developed a whole range of accessories to enhance your A1, enabling you to customise it down to the last detail. Like your Audi, all these accessories are developed to the highest possible standards. And they're all available exclusively from Audi. To find out more, just visit your local Audi Centre.

## Warranty

All of the accessories available on the A1 are covered by a three-year warranty\* if they are ordered and included in the purchase price of the car at date of delivery. Any accessories ordered and installed after delivery include a two-year warranty.\*



Sport and design



Transport and touring



Entertainment and communication

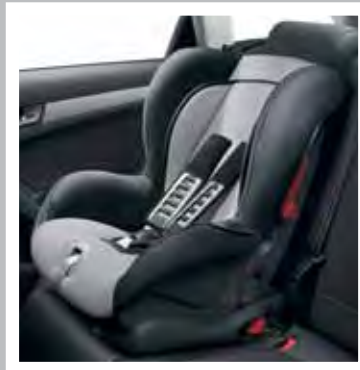

Family



Transport and touring



Safety and security

\*Excluding Road Angel products.

Audi Accessories warranty terms and conditions can be found at [audi.co.uk](http://audi.co.uk)

# A1

## technical data

Engine	Petrol					Diesel
	1.2 TFSI	1.4 TFSI	1.4 TFSI Sport	1.4 TFSI S line	1.4 TFSI S line	1.6 TDI
Transmission	5-speed manual	6-speed manual	7-speed S tronic	7-speed S tronic	7-speed S tronic	5-speed manual
Cylinder	4-cylinder	4-cylinder	4-cylinder	4-cylinder	4-cylinder	4-cylinder
Displacement, cubic cm (valves per cylinder)	1197	1390	1390	1390	1390	1598
Max. power <sup>1</sup> , PS at rpm	86/4800	122/5000	122/5000	122/5000	185/6200	105/4400
Max. torque, Nm at rpm	160/1500-3500	200/1500-4000	200 / 1500-4000	200 / 1500-4000	250/2000-4500	250/1500-2500
0-62mph acceleration, seconds	11.7	8.9	8.9	8.9	6.9	10.5
Top speed <sup>2</sup> , mph	112	126	126	126	141	118
CO <sub>2</sub> emissions <sup>3</sup> , g/km	118	124	119	122	139	99
Benefit in kind (BIK)%	10%	15%	10%	15%	17%	13%
Fuel consumption <sup>3</sup> , mpg (l/100km) Urban	45.6 (6.2)	41.5 (6.8)	43.5 (6.5)	43.5 (6.5)	37.7 (7.5)	64.2 (4.4)
Fuel consumption <sup>3</sup> , mpg (l/100km) Extra Urban	64.2 (4.4)	64.2 (4.4)	64.2 (4.4)	61.4 (4.6)	55.4 (5.1)	83.1 (3.4)
Fuel consumption <sup>3</sup> , mpg (l/100km) Combined	55.4 (5.1)	53.3 (5.3)	54.3 (5.2)	53.3 (5.3)	47.9 (5.9)	74.3 (3.8)
ABI insurance group 1-50 <sup>4</sup>	9 E	15 E / 16 E*	15 E / 16 E*	16 E	28 E	14 E / 15 E*
Unladen weight <sup>4</sup> , kg	1040	1100	1125	1125	1190	1140
Gross weight limit, kg	1490	1550	1575	1575	1640	1590
Roof load limit/nose weight, kg	75	75	75	75	75	75
Max trailer load unbraked <sup>5</sup> , kg	550	580	600	600	630	600
Max trailer load with 12% gradient <sup>5</sup> , kg	1000	1200	1200	1200	1200	1200
Max trailer load with 8% gradient <sup>5</sup> , kg	1200	1200	1200	1200	1200	1200
Luggage compartment capacity, rear seats upright, litres**	270	270	270	270	270	270
Luggage compartment capacity, rear seats folded, litres**	920	920	920	920	920	920
Fuel tank capacity approx, litres	45	45	45	45	45	45

\*Competition Line.

\*\*Please note that luggage capacity is reduced when BOSE® surround sound is fitted.

<sup>4</sup>Highest insurance group rating shown. Group may be lower dependent on trim level. Please visit [www.thatcham.org/abigruprating](http://www.thatcham.org/abigruprating) for details.

**Please note:** The maximum power output figures are quoted in PS (or Pferdestärke, which is the metric equivalent of brake horsepower). To convert to brake horsepower, divide the PS figure by 1.0139.

<sup>1</sup>The given value was obtained in accordance with the specified measurement procedure (the respective current version of the Directive 80/1269/EEC).

<sup>2</sup>Top speed is achieved in top gear.

<sup>3</sup>Fuel consumption and CO<sub>2</sub> emissions figures are obtained under standardised test conditions (Directive 93/116/EEC) using a representative model. This allows direct comparison between different models from different manufacturers, but may not represent the actual fuel consumption achieved in 'real world' driving conditions. More information is available at [www.vca.gov.uk](http://www.vca.gov.uk).

<sup>4</sup>Vehicle's unladen weight without driver (calculated in accordance with the current version of Directive 80/1268/EEC). The fitting of additional equipment may increase the vehicle's unladen weight and drag coefficient, whereupon the potential carrying capacity and top speed will be correspondingly reduced.

<sup>5</sup>The engine's power output always goes down with increasing altitude. At 1,000m above sea level, and for every additional 1,000m, deduct 10% from the weight of the outfit (trailer load limit + gross weight of the towing vehicle).



# A1 dimensions

The technical drawings opposite show the exact dimensions of the A1, so you can check everything – from whether the car will fit in your garage to whether your luggage will fit in the boot.

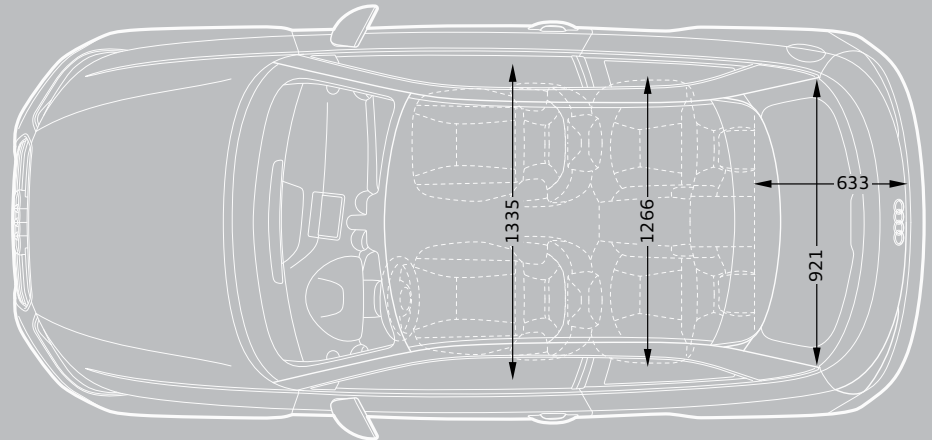
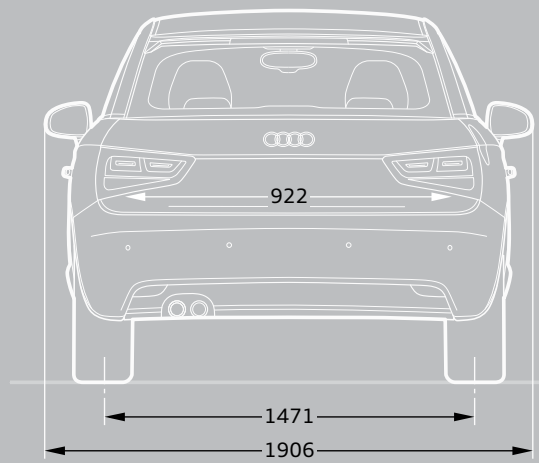
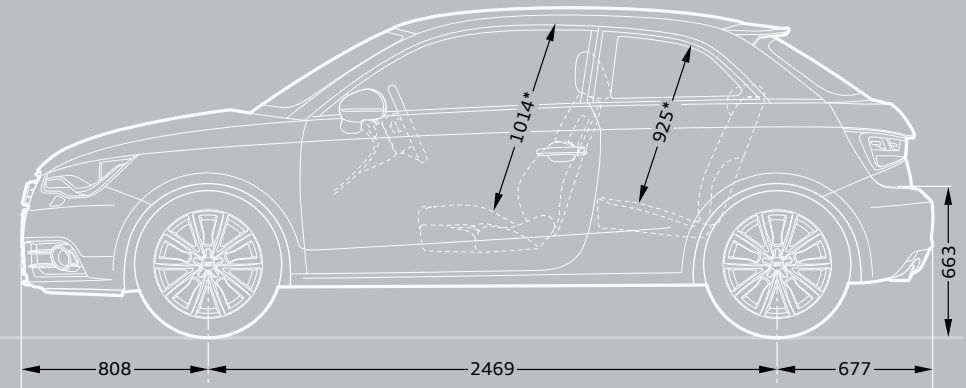
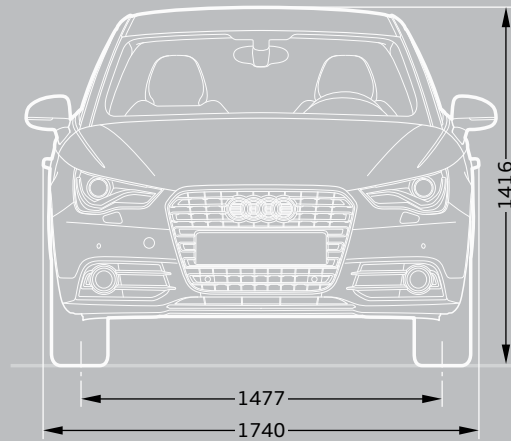

Dimensions were measured with vehicle at unladen weight.

Turning circle approx 10.7m.

Dimensions in millimetres.

\*Maximum headroom.

# Additional information

## CO<sub>2</sub> data and information

### CO<sub>2</sub> emissions-based Vehicle Excise Duty

Vehicle Excise Duty (Road Fund Licence) is based upon the amount of Carbon Dioxide (CO<sub>2</sub>) a vehicle emits, measured in grams per kilometre (g/km).

First year VED rates apply to the first year of ownership. Annual VED rates apply thereafter. The DVLA has created thirteen categories:

Petrol and Diesel engines	First year	Annual rate (second year onwards)
A – up to 100g/km	£0.00	£0.00
B – 101 to 110g/km	£0.00	£20.00
C – 111 to 120g/km	£0.00	£30.00
D – 121 to 130g/km	£0.00	£95.00
E – 131 to 140g/km	£115.00	£115.00
F – 141 to 150g/km	£130.00	£130.00
G – 151 to 165g/km	£165.00	£165.00
H – 166 to 175g/km	£265.00	£190.00
I – 176 to 185g/km	£315.00	£210.00
J – 186 to 200g/km	£445.00	£245.00
K – 201 to 225g/km	£580.00	£260.00
L – 226 to 255g/km	£790.00	£445.00
M – over 255g/km	£1,000.00	£460.00

Vehicle Excise Duty (VED) rates correct at time of going to print, but these may alter to reflect any change in the applicable VED rate

### Servicing tailored to your needs

Regular servicing is key to safeguarding your Audi's performance and a full Audi service history could help you preserve the future re-sale value. To make servicing easy, the Audi Service Schedules have been designed to work with your individual driving style and vehicle.

There are two schedules available and your Audi Centre will advise which schedule is most suited to your needs. The conventional fixed Audi Inspection Service schedule has fixed intervals for the Oil-change and Inspection Service that are based on

time and distance, whichever comes first. With the Audi LongLife Service schedule, sensors take account of driving style and conditions in which the vehicle is used to indicate when the Oil-change Service is required. Oil-change Service intervals are therefore variable and are conveniently indicated via the on-board service interval display.

Fixed Inspection Service Schedule		Variable LongLife Service Schedule	
	Vehicle usage:		Vehicle usage:
Mileage	Less than 10,000 miles per annum	Mileage	More than 10,000 miles per annum
Type of journey	Mainly city/town centre driving. Short journeys	Type of journey	Motorway and main road driving. Mainly longer distance journeys. Constant speeds
Conditions	Frequent cold starts. High engine loading – e.g. frequent hill climbs, vehicle fully loaded, towing	Conditions	Normal engine loading – e.g. with little or no towing, with little or no hill climbs. Normal vehicle loading
Driving style	Uneconomical – e.g. heavy acceleration, heavy braking, constant changes in speed, constant use of high revs, 'sporty' driving	Driving style	Moderate acceleration, moderate braking, engine revs mainly below 3,000
	Service Intervals:		Service Intervals:
Oil-change Service	Fixed to every 9,000* miles/1 year	Oil-change Service	Variable to a maximum of every 19,000* miles/2 years
Inspection Service	Fixed to every 19,000* miles/2 years	Inspection Service	Fixed to every 19,000* miles/2 years

\*As indicated by the service interval display. Mileages are approximate as the Service Indicator system uses kilometres as its distance measurement.

# Additional information

## Welcome to Audi

By placing an order for your Audi, you're choosing to get behind the wheel of one of the most sophisticated cars on the road. And because we believe the service we offer should be just as advanced, we wanted to let you know exactly what you can expect from us, now and in the future.

We've agreed a set of standards with all our Centres, which governs the way we do business with you. It outlines the kind of service we promise to deliver for every customer, right down to filling each new Audi we sell with half a tank of fuel.

So whether you're interested in the date your car will arrive in the UK or the way we'll dispose of non-biodegradable materials after we service your Audi, you can have total confidence in us.

## Audi Promise

### Audi Centres

We guarantee that all of our Centres will be open as follows:

Sales: Monday to Friday 9am–6pm  
Saturday 9am–5pm

Service: Monday to Friday 8am–6pm  
Saturday 8.30am–1pm

Sunday opening is at local discretion.

### New car delivery

Once we've confirmed a delivery date for your car, we'll keep you informed of progress. Subject to reasonable notice, we'll then deliver it to a place of your choice, whether that's your home or place of work. In the unlikely event of a delay, we'll provide a courtesy car to minimise inconvenience and keep you mobile.

### The experts in Vorsprung durch Technik

Would you entrust your Audi to anyone who hasn't been regularly trained to Audi standards? Our network of Audi Approved Master Technicians have undergone an impressive 100,000 hours of training over a 10-year programme to ensure they have the latest technical expertise for maintaining and servicing your Audi. All of our Service Advisors undergo a specialist induction and training to ensure they are Audi professionals and able to talk to you about any issues you may have with your Audi vehicle. What's more, we have so much expertise and experience in looking after Audi vehicles that we are able to make a note of your mileage and the state of your vehicle as and when we see it and predict when certain key events may occur. As part of our commitment to you, we will notify you in plenty of time so you can make an appointment with us.

### Your convenience comes first

At Audi you can choose from a range of convenient services that suit your needs. Why not book a 'service while you wait' appointment\* and enjoy our complimentary refreshments while your car is with us? Or, if you need to be mobile, take advantage of one of our courtesy cars which we can even collect and deliver to you.\* We guarantee we can service your Audi within 5 days without a courtesy car, or within 10 days if you need transport. We will also ensure your car is returned to you with a full valet.

### Audi Genuine Parts

Would you put a part into your Audi that wasn't the same quality as the factory fitted original? You can rest assured that only Audi Genuine Parts will be used on your vehicle. What's more, Audi parts and labour come with a 2-year guarantee.\*\* We stock a wide variety of parts, so we are well covered. However, if we don't have a part in stock at our Centre we have the back-up of parts at other Audi Centres, at our national warehouse and our factory and can usually source the relevant part very quickly.

### We don't like surprises either

We believe strongly in transparency and there will be no hidden costs. For added peace of mind, we will give you a quotation over the phone for the work you have requested and email you the price confirmation. We'll consult you if any additional work on your car is needed when it is with us. We won't carry out any extra work without asking your permission first.

### The Audi Stamp

Regular servicing is key to safeguarding your Audi's performance and a full Audi service history could help you preserve the future re-sale value of your car. Only the Audi Stamp will prove your approved Audi service history.

### Getting better every time

We continually gather feedback from our Audi Trained Technicians, as well as our customers, to ensure our vehicles are running as they should. Whenever we see an Audi for a service, we connect it directly to our headquarters in Ingolstadt which enables us to check your car's software and make sure it's as up-to-date as possible. If the factory has released a software upgrade for your model, it can be applied immediately – improving anything from your car's efficiency to the precision of its parking system.

### Environmental commitment

We promise to dispose of all non-biodegradable materials from your vehicle in a responsible manner.

\*Subject to availability.

\*\*Excludes wear and tear.



# Pricing information

## Pricing

Prices and specifications given are correct at the time of printing. Always check details with your Audi Centre, as Audi policies are continually developing. We reserve the right to change prices or specifications at any time.

All prices are subject to VAT, currently charged at 20%, but this may alter to reflect any change in the applicable VAT rate.

Delivery charges and number plates are not included in the vehicle price.

Delivery charge	£471.66
Number plate	£20.00
VAT	£98.34
Total	£590.00

## Audi Roadside Assistance

Your new car comes complete with 3 years' complimentary roadside assistance and recovery across the UK provided by RAC Motoring Services. Also included is roadside assistance throughout Europe, managed by RAC Motoring Services.

For further information and terms and conditions, please visit [audi.co.uk](http://audi.co.uk)

## Audi Customer Care

Every new Audi benefits from the comprehensive Audi Customer Care Package, which comprises:

- ▶ A 3-year Audi warranty, which covers you for unlimited mileage in the first 2 years of ownership, with a full mechanical and electrical warranty which covers you for up to 60,000 miles in the 3rd year

- ▶ A 3-year paint warranty
- ▶ A 12-year anti-corrosion warranty
- ▶ 3 years' UK roadside assistance and recovery

You also have the option when ordering your new car of choosing a four-year or five-year Audi warranty. Speak to a member of the sales team for more information.

## Audi Tax-Free Sales

If you are entitled to purchase a vehicle free of VAT, normally through Military or Diplomatic privilege, please contact your local Audi Centre for full details.

Should you have any difficulty obtaining the information you require, please call Freephone 0800 585878.

## Audi Finance

Audi Finance specialise in providing funding solutions for Audi drivers. Whether your Audi is for private or business use, there are a range of funding options to choose from

Below is the full range of finance products.

- ▶ Solutions – a Personal Contract Plan
- ▶ Hire purchase
- ▶ Lease purchase
- ▶ Finance lease
- ▶ Contract hire

With all products, you can choose a fixed-cost maintenance plan designed to help you budget accurately.

No matter what Audi model you choose, your local Audi Centre can provide you with a personalised quote which could fit your budget and motoring needs.

Audi Finance is a trading name of Volkswagen Financial Services (UK) Limited. An offer of finance depends on certain conditions. Available to people over 18 in the UK only.

## Audi Insurance

We want you to start enjoying your new car from day one and thanks to Audi Insurance complimentary seven day cover, you can. Call free on 0800 316 7893 (lines are open Monday to Friday 8am - 9pm, and Saturday 9am - 5pm), provide a few details and a cover note will be sent to your Audi Centre. They will then tax your car and you can drive it away.

Audi Insurance is a trading name of Volkswagen Insurance Service (Great Britain) Limited, an appointed representative of Volkswagen Financial Services (UK) Limited, Brunswick Court, Yeomans Drive, Blakelands, Milton Keynes MK14 5LR. Registered in England number 2835230. Audi Insurance is sold, underwritten and administered by Allianz Insurance plc registered in England number 84638. Registered office 57 Ladymead, Guildford, Surrey GU1 1DB. Volkswagen Financial Services (UK) Limited and Allianz Insurance plc are authorised and regulated by the Financial Services Authority. Volkswagen Financial Services (UK) Limited and Allianz Insurance plc are not part of the same corporate group.

**Audi UK**  
Customer Services  
Selectapost 29  
Sheffield  
S97 3FG  
0800 699888  
audi.co.uk

Specifications and prices subject  
to change without notice.

© Audi (UK)

Printed in the UK  
Edition 5.3 08/11  
2012 Model Year

Images are for illustrative purposes only. Models shown are left hand drive.