



**The Audi A7 Sportback**

Pricing and Specification Guide

Valid from May 2011



# Personalising your Audi A7 Sportback

This guide has been designed to help you tailor and price your Audi A7 Sportback quickly and logically. At the back, you will find information on CO<sub>2</sub> emissions-based taxation and the other services offered by Audi, including Finance and Insurance. Alternatively, you can go to [audi.co.uk](http://audi.co.uk) and configure your Audi A7 Sportback online.

## The Audi A7 Sportback

Efficiency	8
Engines	10
Transmissions	11
quattro®	12

## Model details and prices

SE model equipment	14
S line model equipment	16
Model prices	18

## Audi exclusive

20

## Colour and upholstery

Paint	22
Upholstery	24
Colour and trim guide	30
Inlays	34

## Options

Wheels, tyres and suspension	36
Packages	38
Audio and communication	40
Interior equipment	42
Exterior equipment	44
Safety and security	46
Steering wheels	49
Service Plan and Warranty	50
Merchandise	51
Accessories	52

## Technical details

Technical data	53
Dimensions	54
Additional information	55
Pricing information	57





## Vorsprung durch Technik

Three words that express the very essence of Audi. Vorsprung durch Technik isn't a slogan. It's our way of seeing the world. It is the driving force behind our history of innovation that continues into the 21st century. Indeed, many technologies that Audi pioneered remain in our cars today. Some are milestones in the history of the motorcar.

From our beginnings in 1899, to the Auto Union team's Grand Prix successes in the 1930s and our more recent wins at Le Mans, we have always been at the forefront of the motor industry.

Vorsprung durch Technik makes us who we are. To see more of its influence, just read on.

## The Audi A7 Sportback

The Audi A7 Sportback combines sleek lines with a practical four-door design – its innovative shape and lightweight construction make our latest model as refined and elegant as it is versatile. It incorporates technologies like a cockpit-style ‘head-up display’ and optional MMI touchpad control for the Satellite Navigation system. A number of engine options are available – TDI®, FSI® and TFSI® – which combine remarkable performance with fuel-efficient direct-injection technology.





## Efficiency

At Audi, doing less is something we're trying to do more of. We're working to use less fuel, release less CO<sub>2</sub> and waste less energy. It's why we've incorporated a number of more efficient technologies into the Audi A7 Sportback.

## Recuperation

When a vehicle brakes, the discs convert the kinetic energy into thermal energy, which is wasted as it cannot be used. With a recuperation system, like the one in the Audi A7 Sportback, the kinetic energy is converted into useful electrical energy. The way it works is simple. While the car is coasting or braking, the alternator voltage is raised above the level of the basic electrical system, which enables the alternator to generate electrical energy and store it temporarily in the battery. When the vehicle accelerates, this energy is used to relieve the load on the alternator, resulting in a fuel saving of up to 3%.







### **Efficiency programme**

The Driver's Information System in the Audi A7 Sportback comes as standard with a special efficiency programme, which offers up-to-the-minute advice on ways to help improve fuel economy as you drive. It also shows you which items in your car are using energy, and how much they are using, so you can make an informed choice about which ones to switch off.

### **Automatic Start-Stop function**

In heavy traffic, your car still uses fuel and releases CO<sub>2</sub>, even when it's stationary. The automatic Start-Stop function counteracts this problem by switching off the engine when your car comes to a standstill. As soon as you release the brake pedal, the car restarts.

## Engines

### Petrol

FSI® direct-injection technology is a unique Audi innovation that was originally developed for the Le Mans 24-hour endurance race to deliver more power and torque, as well as enhanced fuel efficiency. Precisely the right amount of fuel and air are injected into the combustion chambers, enabling the engine to 'breathe' more easily. It results in reduced heat loss and increased output, with around a 15% reduction in fuel consumption and significantly lower exhaust emissions. We've also developed TFSI®, with turbocharging, which combines FSI® technology with forced induction – giving cars an extra injection of power.

### Diesel

We introduced TDI® to the roads in 1989, marking a departure from the noisy, fuel-thirsty diesel engines of the past. And since then, we've continuously refined it, recently developing common-rail technology. Under this system, a series of piezo injectors use electrical charge to precisely control the amount of fuel injected into the engine. As well as reducing noise, this allows combustion to happen at a lower temperature, with less oxygen, which lowers emissions.





## Transmissions

### **multitronic®**

Translating a driver's preferences and intentions into road performance, the multitronic® transmission system entertains no compromises – whether in terms of dynamism, convenience or economy. multitronic® automatic transmission is available on models without quattro® permanent all-wheel-drive. A continuously variable transmission, multitronic® can transmit up to 400 Nm of torque and permits an exceptionally wide range of gear ratios. The result is smooth, powerful acceleration and a high level of driving comfort. And thanks to its lightweight design and a number of advanced electronic control systems that monitor gradient, road conditions and the way the driver is using the accelerator pedal, multitronic® also plays an instrumental role in reducing fuel consumption.

### **S tronic®**

Driving is all about thinking ahead, which is just what the S tronic® dual-clutch transmission does. It works almost as two separate systems, one engaging the odd-numbered and the other the even-numbered gears. So when you're accelerating in second, it has third gear waiting for you. And once you make the switch, it's already thinking about fourth. With two clutches working together, you can change gears almost instantly while experiencing smooth, uninterrupted power.

## quattro®

It's the technology that has given Audi the edge on the racetrack ever since it was first introduced over 30 years ago – a technology that delivers ultimate control whilst enhancing the sporty characteristics which make the A7 Sportback so thrilling to drive. It's called quattro® permanent all-wheel-drive. The principle is simple: in the same way that four brakes ensure better deceleration, four permanently-driven wheels deliver better acceleration and road-holding, pushing or pulling the car as needed, for a driving experience that's both dynamic and safe.

In the A7 Sportback, asymmetric dynamic torque distribution continuously distributes drive power between the front and rear axles, depending on weather conditions, road surface and gradient. This leads to greater flexibility and an enhanced, sportier drive.

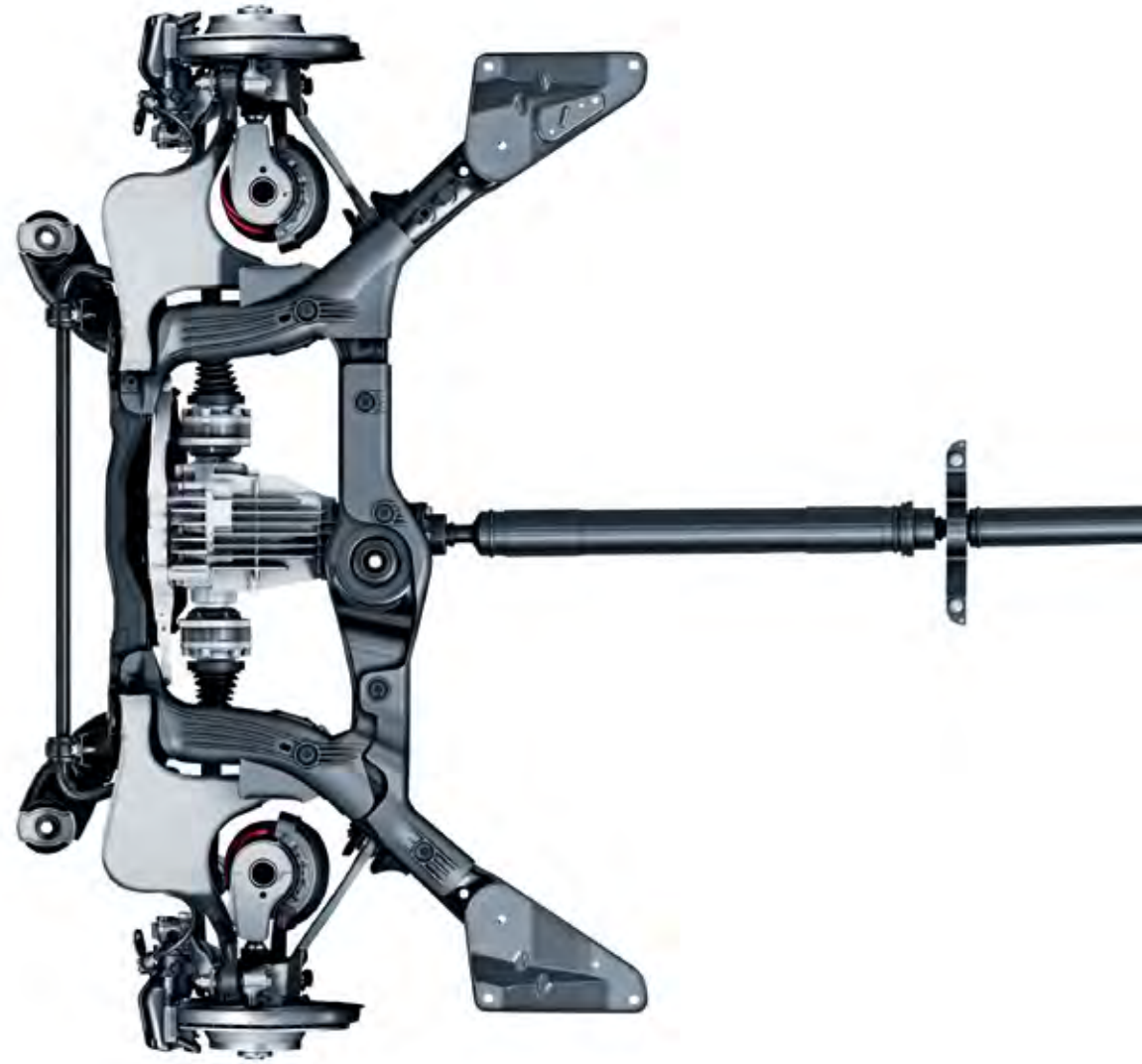

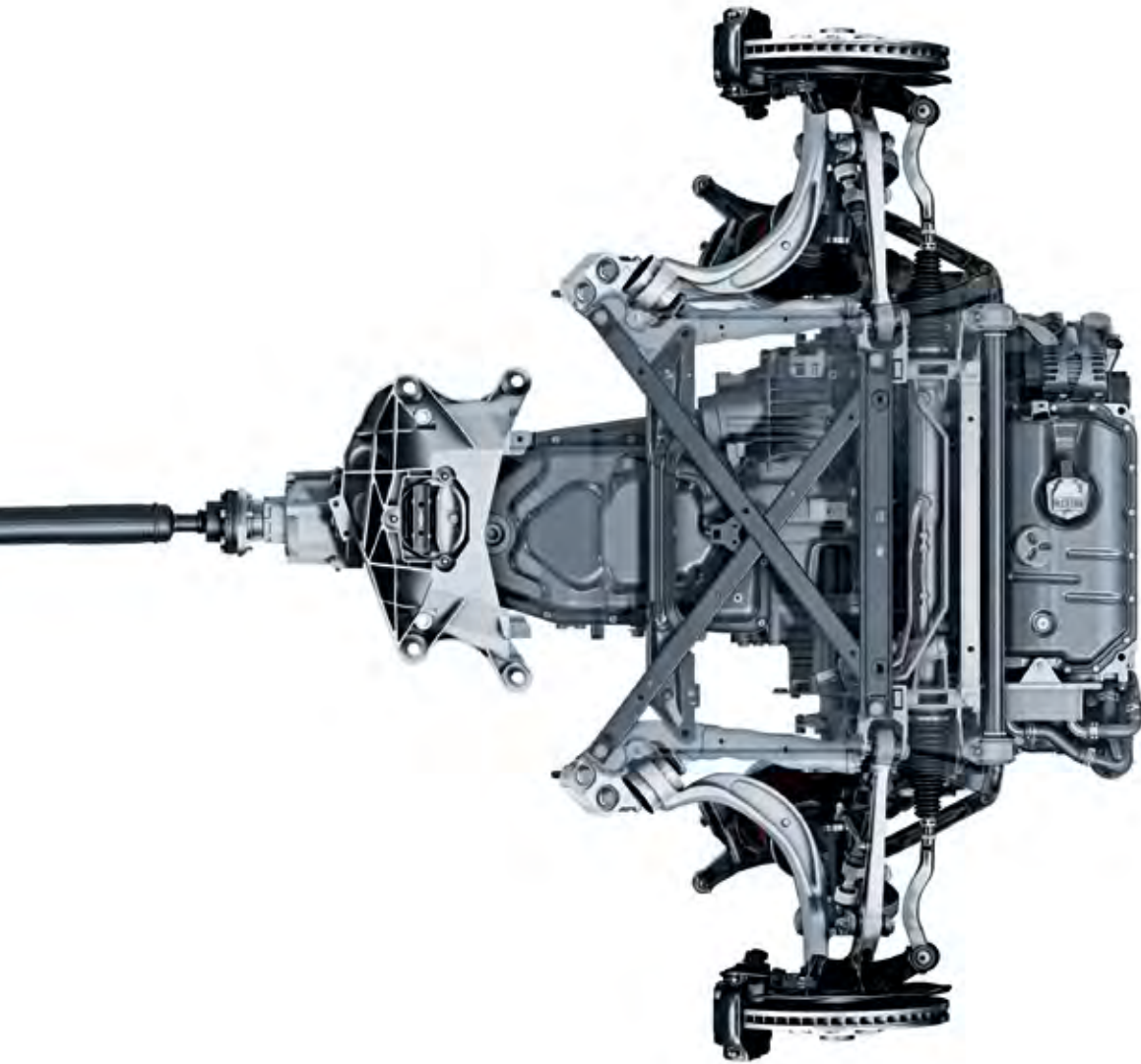

### **quattro® with Sports differential**

The optional electronically regulated Sports differential distributes variable amounts of drive force to each rear wheel, ensuring outstanding acceleration performance in corners and stabilising the vehicle's response to load change. It also brings better direct steering characteristics and, as it requires less steering effort, more agile handling.

## SE model equipment

All A7 Sportback SE models have the following items of standard equipment

### Engines

Start-Stop system with energy recovery

### Wheels, tyres and suspension

18" x 8.5J '7-arm Dynamic' design alloy wheels, with 255/45 tyres

Audi drive select with four pre-configured modes (Comfort, Auto, Dynamic and Efficiency), allowing the driver to electronically adjust the engine, transmission and steering. The new efficiency mode influences the shift program, electromechanical power steering, engine, cruise control, and where fitted: deluxe automatic air conditioner, adaptive air suspension, quattro® with Sports differential

Locking wheel bolts

Space-saver spare wheel

### Audio and communication

Audi Music Interface – universal connection for use with stereo audio sources, USB and MP3 devices including Apple iPod generation 4 onwards (iPod, iPod classic, iPod mini, iPod nano, iPod photo, iPod video, iPod touch). Provides intuitive control through the audio system and multi-function steering wheel. It also replicates the iPod display on the audio screen and Driver's Information System (DIS), including track titles. The interface provides charging function (dependent on device)

Audi sound system

- 6-channel amplifier
- 180-Watt amplifying capacity
- 10 loudspeakers including subwoofer located in spare wheel well

DAB digital radio – includes a second DAB tuner that permanently searches for alternative reception frequencies of the set station and also updates the station list

Colour Driver's Information System (DIS) with 7-inch high resolution TFT screen

MMI Radio Plus including:

- MMI control panel operating the MMI display (6.5-inch colour display on the dashboard)
  - 2 x SDHC memory card readers (up to 32GB)
  - single CD player and memory card reader that supports MP3, WMA and AAC
  - TP memo – automatically saves traffic news when driving
- MMI Navigation (SD card based) including:
- 6.5-inch MMI colour display with high quality map display
  - voice control using whole words
  - dynamic route guidance

Mobile telephone preparation – Bluetooth interface. Provides handsfree connection via Bluetooth using the mobile phone aerial. Please contact your Audi Centre for compatibility



18" x 8.5 '7-arm Dynamic' design alloy wheel – PRW



Mobile telephone preparation



Split-folding rear seats with power-operated tailgate

### Safety and security

Auto-dimming rear-view mirror

Anti-theft alarm

Cruise control

Light and rain sensor – automatic activation of windscreen wipers and headlights

Electronic Stability Programme (ESP)

Side air bag (front) with curtain air bag

Tool kit, warning triangle and car jack

Tyre pressure monitoring system

Keyless go – conveniently allows the engine to be started by simply pressing the start/stop button in the centre console. The key just needs to be carried

### Seats

Split-folding rear seat with 3 head restraints and 3 rear seat belts (available with only 2 head restraints and 2 rear seat belts at no extra cost)

Electrically adjustable front seats.

Including adjustment for:

- Forwards/backwards position
- Seat height and angle
- Backrest angle
- Memory function for driver's side

Electrically adjustable 4-way lumbar support

Heated seats for driver and front-passenger seats; heats the seat cushions, backrest surfaces and seat side bolsters and can be individually adjusted in 3 stages for each seat via a direct selection button on the air conditioning controls

ISOFIX child seat mounting for front passenger (with airbag deactivation) and outer rear seats

Milano leather upholstery

### Interior equipment

4-spoke leather-trimmed multi-function steering wheel – with gear-shift paddles

Electronically controlled automatic air conditioning – separate temperature distribution for driver and front passenger

Door sill trims with aluminium inlay

Inlays in matt brushed aluminium

Light package. Includes lighting for:

- Exterior: courtesy lighting on the underside of the door handles and door handle lighting with LED technology; automatically activated when the doors are unlocked; includes active internal door reflectors
- Interior: LED technology – 2 reading lights at front and rear, front footwell, inside door handles, make-up lights, storage compartment in the centre console, ambient lighting of the centre console, ambient reflected light for inside door trims

Floor mats, front and rear, coordinated with the selected interior colour

Front centre armrest for driver and front passenger, movable and with adjustable angle

### Exterior equipment

Audi Parking System Plus: acoustic and visual park assist system for the front and rear with MMI screen display

Exterior mirrors: with memory function, heated, electrically adjustable

Headlight washer system

High gloss package

Power-operated boot lid, electrically opening and closing

LED tail-lights

Xenon Plus headlights with LED daytime-running lights

Retractable rear spoiler



3 rear seats in Velvet beige Valcona leather upholstery

# S line model equipment

## In addition to SE model equipment

**Basic RRP**

£1,491.67

**Total RRP inc VAT**

£1,790.00

### Wheels, tyres and suspension

19" x 9J '5-twin-spoke' design alloy wheels with 255/40 R19 tyres  
Sports suspension lowered by 10mm with more firmly tuned springs and dampers for more direct contact with the road

### Seats

Electrically adjustable front Sports seats including memory function for the driver's side  
Seats upholstered in black Valcona leather with embossed S line logo in the front seat backrests

### Interior equipment

Black headlining  
Door sill trims with S line logo  
Gear lever knob in black perforated leather  
S line 3-spoke leather multi-function Sports steering wheel with paddles and S line badge  
S line inlays in matt brushed aluminium

### Exterior equipment

Platinum grey front spoiler lip and diffuser insert  
S line badges on the front wings  
S line front and rear bumpers, side ventilation grilles, side skirts and diffuser insert



19" x 9J '5-twin-spoke' design alloy wheels – PQG



S line 3-spoke multi-function steering wheel



S line body styling





## A7 Sportback SE

Engines	Power	Transmissions	CO <sub>2</sub> g/km	Basic RRP	Total RRP inc VAT	Recommended OTR
2.8 FSI quattro	204PS	7-speed S tronic	187	£36,791.67	£44,150.00	£45,240.00
3.0 TFSI quattro	300PS	7-speed S tronic	190	£39,166.67	£47,000.00	£48,090.00
3.0 TDI	204PS	8-speed multitronic	135	£35,833.33	£43,000.00	£43,760.00
3.0 TDI quattro	245PS	7-speed S tronic	156	£39,333.33	£47,200.00	£48,010.00

## A7 Sportback S line

Engines	Power	Transmissions	CO <sub>2</sub> g/km	Basic RRP	Total RRP inc VAT	Recommended OTR
2.8 FSI quattro	204PS	7-speed S tronic	187	£38,283.33	£45,940.00	£47,030.00
3.0 TFSI quattro	300PS	7-speed S tronic	190	£40,658.33	£48,790.00	£49,880.00
3.0 TDI	204PS	8-speed multitronic	135	£37,325.00	£44,790.00	£45,550.00
3.0 TDI quattro	245PS	7-speed S tronic	156	£40,825.00	£48,990.00	£49,800.00

**Please note:** The maximum power output figures are quoted in PS (or Pferdestärke, which is the metric equivalent of brake horsepower). To convert to brake horsepower, divide the PS figure by 1.0139.

**Recommended On-The-Road (OTR) retail prices include:** delivery charge, half a tank of fuel, number plates at £590.00 (inc. VAT), Road Fund Licence (which may vary depending on model/transmission – see page 55 for details) and first registration fee at £55.00. Vehicle Excise Duty correct at time of going to print, but this may alter to reflect any change in the applicable VED rate.

RRP - Recommended Retail Price.

VAT is calculated at 20% but this may alter to reflect any change in the applicable VAT rate.





## Audi exclusive



Comfort seats in Audi exclusive leather (Package 2) in Alabaster white and Chesnut brown. Audi exclusive inlays shown in oak sepiá

Every Audi is intrinsically exclusive. It's the breathtaking design, the exceptional engineering, the Vorsprung durch Technik. But for that special touch you can specify your new A7 with options from Audi exclusive. Whether you want a unique, custom-mixed paint colour or seats in a combination of complementary shades, Audi exclusive will enable you to drive the car you've always imagined.

Both the exclusive and standard options can be found on the following pages.

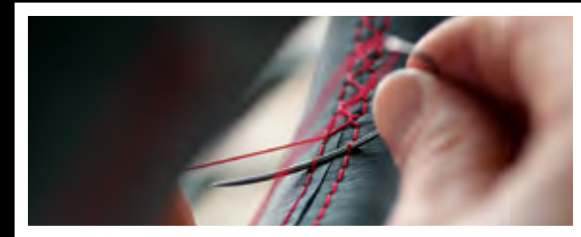
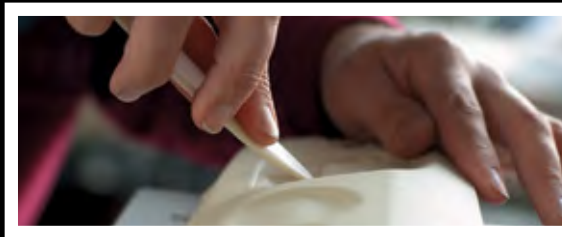
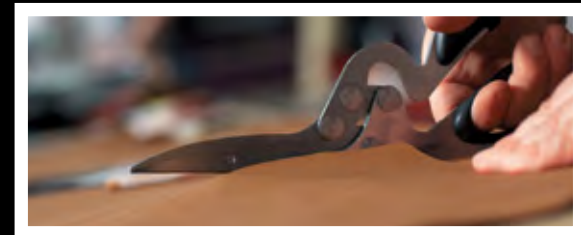
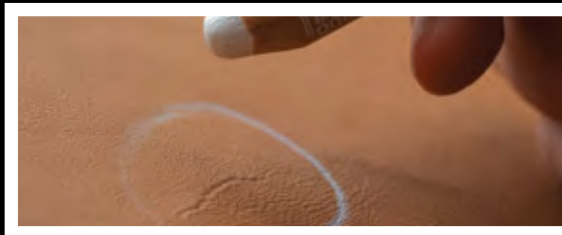

# Paint

You can select one of the standard colours shown opposite or, for a different look, choose from a range of optional finishes.

Options are subject to availability and may extend delivery.

All the colour swatches on this page are matched as accurately as possible to the actual paint colours used. However, due to print processes, Audi UK cannot guarantee that colours shown are 100% accurate.

Visit your local Audi Centre for a more accurate colour swatch.

RRP – Recommended Retail Price.

VAT is calculated at 20% but this may alter to reflect any change in the applicable VAT rate.

## Standard colours



Ibis white – T9

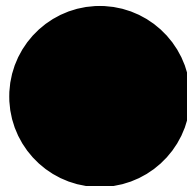

Brilliant black – A2

## Optional colours

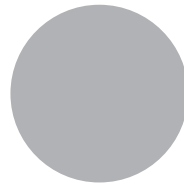

Ice silver, metallic – P5

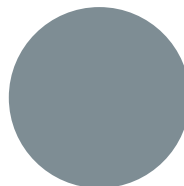

Quartz grey, metallic – Q4

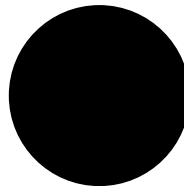

Oolong grey, metallic – 4N



Glacier white, metallic – 2Y

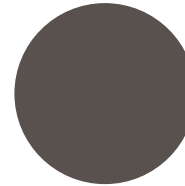

Dakota grey, metallic – Y7

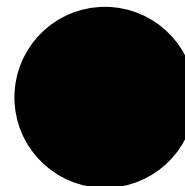

Havana black, metallic – 4J

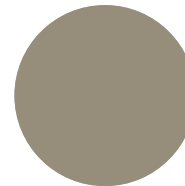

Impala beige, pearl effect – T2

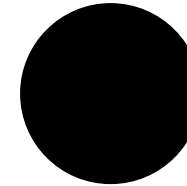

Phantom black, pearl effect – L8

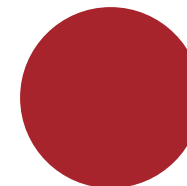

Garnet red, pearl effect – 9C

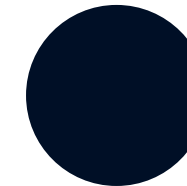

Moonlight blue, metallic – W1

## S line colours

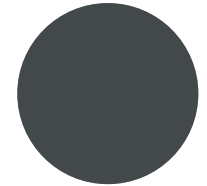

Daytona grey, pearl effect – 6Y

### Optional and S line colours

**Basic RRP**  
£625.00

**Total RRP inc VAT**  
£750.00

# Paint

## Audi exclusive

Everyone has a favourite colour. No matter what yours is, Audi exclusive provides a range of unique colours that have been designed to set your car apart. Choose from the swatches here, or specify any other paint colour in the Audi range – whether it's Jet blue from the Audi R8 or Alpine white from the original Audi quattro. The choice is yours.

## Customised

If you have a particular colour in mind, we'll mix the exact metallic or pearl-effect shade you want.\*

\*Custom paint is subject to factory approval, and is available for metallic and pearl-effect water-based paints only. Three-colour process colours and two-tone schemes are not available.

\*Visit your local Audi Centre for colour samples.

All the colour swatches on this page are matched as accurately as possible to the actual paint colours used. However, due to print processes, Audi UK cannot guarantee that colours shown are 100% accurate.

Visit your local Audi Centre for a more accurate colour swatch.

RRP – Recommended Retail Price.

VAT is calculated at 20% but this may alter to reflect any change in the applicable VAT rate.



Palace blue, pearl effect

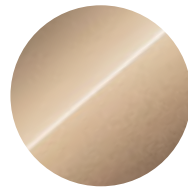

Sand beige, pearl effect

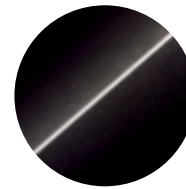

Saddle brown, pearl effect

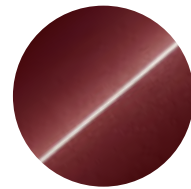

Classic red, pearl effect

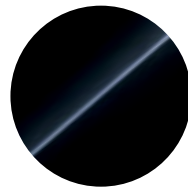

Mamba black, metallic

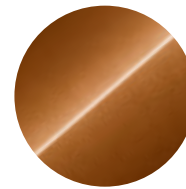

Ipanema brown, metallic



Any colour in the Audi range



100 Audi exclusive colours to choose from\*



Customised paint

### Audi exclusive

Basic RRP  
£1,541.67

Total RRP inc VAT  
£1,850.00

### Customised\*

Basic RRP  
£2,458.33

Total RRP inc VAT  
£2,950.00

# Upholstery

## Standard seats

Choose your favourite upholstery from the swatches shown opposite to give your car's interior the look and feel you want.

Milano leather  
– NSW



Black – FZ



Titanium grey – VC

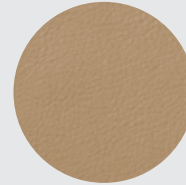

Velvet beige – VD

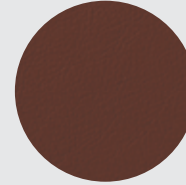

Nougat brown – VB

Valcona leather  
– NSD



Black – FZ



Titanium grey – VC

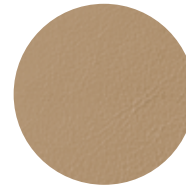

Velvet beige – VD

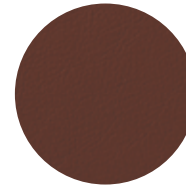

Nougat brown – VB

SE	S line	Basic RRP	Total RRP inc VAT
S	–	No charge	No charge
•	–	£283.00	£340.00

Options are subject to availability and may extend delivery.

- = Not available
- = Available
- S = Standard

All leather upholstery choices include seats, head restraints, door inserts and front centre armrest in leather.

RRP – Recommended Retail Price.

VAT is calculated at 20% but this may alter to reflect any change in the applicable VAT rate.



Standard seat



## Standard seats

Choose your favourite upholstery from the swatches shown opposite to give your car's interior the look and feel you want.

Order Code		SE	S line	Basic RRP	Total RRP inc VAT
-	<b>4 seat option.</b> Includes only 2 rear seat belts and headrests for the rear	●	—	No charge	No charge
<b>4A4</b>	<b>Front and rear heated seats</b> – works in the same way as front seat heating, enabling you to regulate the rear seats separately. Only in combination with deluxe 4-zone climate control (9AQ)	●	—	£300.00	£360.00
<b>4D3</b>	<b>Seat ventilation for front seats</b> – 3 different intensities of cool air are drawn through the seat (for Comfort seats) or a fan (for Standard seats) provides active ventilation of the seat centre section and thigh support. To allow for the seat ventilation, the leather of the seat front is perforated. When ordered in combination with Standard seats, must be combined with deluxe 4-zone climate control (9AQ) and Milano leather (N5W)	●	—	£700.00	£840.00

Options are subject to availability and may extend delivery.

– = Not available  
● = Available  
S = Standard

All leather upholstery choices include seats, head restraints, door inserts and front centre armrest in leather.

RRP – Recommended Retail Price.

VAT is calculated at 20% but this may alter to reflect any change in the applicable VAT rate.

# Upholstery

## Comfort seats (PS8)

18-way adjustable seats with memory function for both front seats and mirrors. Electric adjustment of seat forward and backward position, cushion angle, height, thigh support and backrest angle. Manual adjustment of seat belt height and head rest height and proximity. Pneumatic adjustment of bolsters (on backrest and seat cushion) and lumbar support.

Options are subject to availability and may extend delivery.

- = Not available
- = Available
- S = Standard

All leather upholstery choices include seats, head restraints, door inserts and front centre armrest in leather. Leather/Alcantara choices include head restraints, seat side bolsters and front centre armrest in leather with the seat centres and door inserts in Alcantara.

\* When choosing Valcona leather with Comfort seats you must also have seat ventilation (4D3/4D8) and 4-zone climate control (9AQ).

RRP – Recommended Retail Price.

VAT is calculated at 20% but this may alter to reflect any change in the applicable VAT rate.

Milano leather  
– NSW



Black – FZ



Titanium grey – VC



Velvet beige – VD

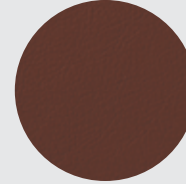

Nougat brown – VB

Valcona leather\*  
– NSD



Black – FZ

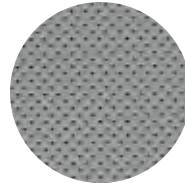

Titanium grey – VC

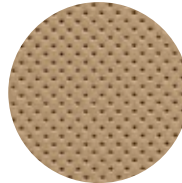

Velvet beige – VD

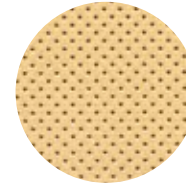

Goa beige – VA

SE	S line	Basic RRP	Total RRP inc VAT
•	-	£1,083.33	£1,300.00
•	-	£1,366.66	£1,640.00



Comfort seat

## Comfort seats – PS8

Choose your favourite upholstery from the swatches shown opposite to give your car's interior the look and feel you want.

Order Code		SE	S line	Basic RRP	Total RRP inc VAT
-	<b>4 seat option.</b> Includes only 2 rear seat belts and headrests for the rear	●	-	No charge	No charge
<b>4A4</b>	<b>Front and rear heated seats</b> – works in the same way as front seat heating, enabling you to regulate the rear seats separately. Only in combination with deluxe 4-zone climate control (9AQ)	●	-	£300.00	£360.00
<b>4D3</b>	<b>Seat ventilation for front seats</b> – 3 different intensities of cool air are drawn through the seat (for Comfort seats) or a fan (for Standard seats) provides active ventilation of the seat centre section and thigh support. To allow for the seat ventilation, the leather of the seat front is perforated. When ordered in combination with Comfort seats, must be combined with deluxe 4-zone climate control (9AQ) and Valcona leather (NSD)	●	-	£700.00	£840.00
<b>4D8</b>	<b>Massage and seat ventilation for front seats.</b> Massage function with 5 different programmes (wave, pulse, stretch, lumbar, shoulders) and 4 levels of intensity for massaging the muscles using 10 pneumatic cushions. 3 different intensities of cool air are drawn through the seat for active ventilation of the seat centre section and thigh support. To allow for the seat ventilation, the leather of the seat front is perforated. Only in combination with Comfort seats (PS8), deluxe 4-zone climate control (9AQ) and Valcona leather (NSD)	●	-	£1,333.33	£1,600.00

Options are subject to availability and may extend delivery.

- = Not available  
● = Available  
S = Standard

All leather upholstery choices include seats, head restraints, door inserts and front centre armrest in leather.

RRP – Recommended Retail Price.

VAT is calculated at 20% but this may alter to reflect any change in the applicable VAT rate.

# Upholstery

## S line Sports seats

Front S line electrically adjustable Sports seats including 4-way electrical lumbar adjustment and memory function for driver's side. Front seats with 'S line' logo.

If you select Alacantara/Pearl Nappa leather this comes with black/jet grey stitching on seats, steering wheel, gear lever gaiter and floor mats.

Valcona leather  
- N1V

Perforated leather/Alcantara  
- N7K



Black - QE



Black - QZ

Options are subject to availability and may extend delivery.

- = Not available  
• = Available  
S = Standard

All leather upholstery choices include seats, head restraints, door inserts and front centre armrest (if fitted) in leather.

RRP - Recommended Retail Price.

VAT is calculated at 20% but this may alter to reflect any change in the applicable VAT rate.

	SE	S line	Basic RRP	Total RRP inc VAT
-	-	S	No charge	No charge
-	-	•	No charge	No charge

Order Code	SE	S line	Basic RRP	Total RRP inc VAT
- <b>4 seat option.</b> Includes only 2 rear seat belts and headrests for the rear	-	•	No charge	No charge
<b>4A4</b> <b>Front and rear heated seats</b> - works in the same way as front seat heating, enabling you to regulate the rear seats separately. Only in combination with deluxe 4-zone climate control (9AQ)	-	•	£300.00	£360.00



S line interior in Alcantara/leather

# Colour and trim guide

## Interior trim colours

### Standard seats

To help you choose the right interior for your new A7 Sportback, please use this guide, showing the carpet, dashboard and headlining colours that have been matched to your chosen upholstery.

Order Code	Upholstery	Carpet	Dashboard (upper/lower)	Headlining	Milano leather (N5W)	Valcona leather (N5D)
FZ	Black	Black	Black	Lunar silver	●	●
VA	Goa beige	Black	Black	Black	—	●
VB	Nougat brown	Black	Black	Lunar silver	●	●
VC	Titanium grey	Steel grey	Steel grey/Titanium grey	Lunar silver	●	●
VD	Velvet beige	Moor brown	Moor brown/Velvet beige	Silk beige	●	●
KN*	Titanium grey	Titanium grey	Steel grey/Titanium grey	Lunar silver	●	●
KP*	Velvet beige	Velvet beige	Moor brown/Velvet beige	Silk beige	●	●

### Comfort seats

Order Code	Upholstery	Carpet	Dashboard (upper/lower)	Headlining	Milano leather (N5W)	Valcona leather (N5D)
FZ	Black	Black	Black	Lunar silver	●	●
VA	Goa beige	Black	Black	Black	—	●
VB	Nougat brown	Black	Black	Lunar silver	●	—
VC	Titanium grey	Steel grey	Steel grey/Titanium grey	Lunar silver	●	●
VD	Velvet beige	Moor brown	Moor brown/Velvet beige	Silk beige	●	●
KN*	Titanium grey	Titanium grey	Steel grey/Titanium grey	Lunar silver	●	●
KP*	Velvet beige	Velvet beige	Moor brown/Velvet beige	Silk beige	●	●

\*Including two-section dashboard and door trim panels, single/multi-tone.

Options are subject to availability and may extend delivery.

— = Not available  
● = Available

RRP – Recommended Retail Price.

VAT is calculated at 20% but this may alter to reflect any change in the applicable VAT rate.

# Colour and trim guide

## Interior trim colours

### S line Sports seats

Order Code	Upholstery	Carpet	Dashboard (upper/lower)	Headlining	Alcantara/Pearl Nappa leather (N7K)	Valcona leather (N1V)
<b>QZ (Jet grey stitching)**</b>	Black	Black/Black	Black	Black	●	—
<b>QE (Black stitching)</b>	Black	Black/Black	Black	Black	—	●

\*\*Black/jet grey stitching on seats, steering wheel, gear lever gaiter and floor mats.

Options are subject to availability and may extend delivery.

- = Not available
- = Available

RRP – Recommended Retail Price.

VAT is calculated at 20% but this may alter to reflect any change in the applicable VAT rate.

# Upholstery

## Audi exclusive

With Audi exclusive, you can specify your seats in Valcona, Fine Nappa leather or a leather/Alcantara combination, in an array of different colours shown to the right.

Select just one all-over shade for each seat, or customise each panel in two or more complementary colours from the distinctive Audi exclusive palette. You can even choose the colour of the decorative stitching – to match or contrast with your chosen upholstery – from this varied collection. Whatever combination you decide upon, we think you'll be extremely comfortable with the result.



Chestnut brown

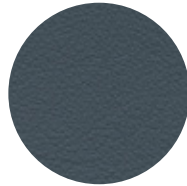

Jet grey



Alabaster white

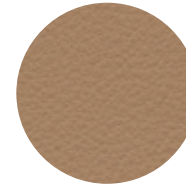

Sand beige

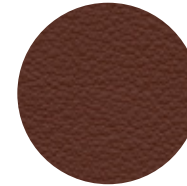

Saddle brown

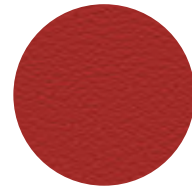

Crimson red



Magnolia white



Havanna brown

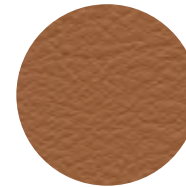

Cognac brown

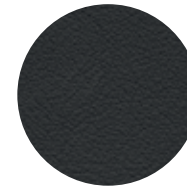

Night blue

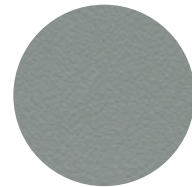

Cloudy grey

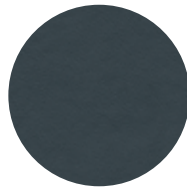

Smoky blue

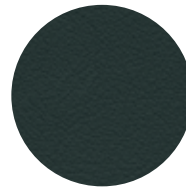

Iceland green



Powder beige



Classic red

### Also available:

**Alcantara colours:** available in all the Audi exclusive colours shown, except for Crimson red, Jet grey and Sand beige. Alcantara equivalents are Chilli red, Amethyst grey, and Sesame beige respectively.

Please consult your Audi Centre for examples of Alcantara and carpet colours.



# Upholstery

## Audi exclusive

Order Code		SE	S line	Basic RRP	Total RRP inc VAT
<b>PYB S3G</b>	<b>Audi exclusive leather package 1 in Valcona leather.</b> Includes leather-covered seat upholstery, door trim inserts, head restraints and front centre armrest	●	●	£4,166.67	£5,000.00
<b>PYC S3G</b>	<b>Audi exclusive leather package 1 in Valcona leather/Alcantara.</b> Includes leather-covered seat-side trims, head restraints and front centre armrest and Alcantara door trim inserts and seat centre sections	┆	●	£4,166.67	£5,000.00
<b>PYE S3G</b>	<b>Audi exclusive leather package 2 in Valcona leather.</b> Includes all the contents of leather package 1 (PYB/S3G) plus: leather-covered seat backrest covers, door armrests and handles and lower centre console. Seat-side trims and add-on parts are colour coordinated	●	●	£7,225.00	£8,670.00

Options are subject to availability and may extend delivery.

- = Not available  
● = Available  
S = Standard

\*Leather and stitching colours (where applicable) can be specified in a variety of colours from the Audi exclusive range.

RRP – Recommended Retail Price.

VAT is calculated at 20% but this may alter to reflect any change in the applicable VAT rate.

# Inlays

Inlays are the all-important finishing touch that add flair and interest to your car's interior.

Order Code		SE	S line	Basic RRP	Total RRP inc VAT
5MG	Walnut, brown	●	—	£350.00	£420.00
7TL	Fine grain ash, natural brown	●	●	£350.00	£420.00
5MT	Oakwood beaufort	●	—	£612.50	£735.00
5TL	Piano finish, black	—	●	£733.33	£880.00



Walnut, brown – 5MG

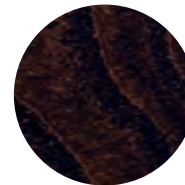

Fine grain ash, natural brown – 7TL



Oakwood, beaufort – 5MT

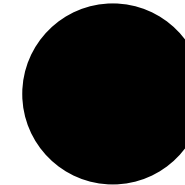

Piano finish, black – 5TL



Inlays in Oakwood beaufort

Options are subject to availability and may extend delivery.

- = Not available
- = Available
- S = Standard

RRP – Recommended Retail Price.

VAT is calculated at 20% but this may alter to reflect any change in the applicable VAT rate.

# Inlays

## Audi exclusive

Audi exclusive has sourced a wide range of materials which you can select for your inlays, from Fine grain ash nougat to Oak sepia.

Order Code		SE	S line	Basic RRP	Total RRP inc VAT
YTA	<b>Audi exclusive inlays.</b> Cannot be combined with inlays shown on page 34. Not in combination with wooden Sports steering wheel	●	●	£1,137.50	£1,365.00



Fine grain ash, nougat



Fine grain myrtle, nutmeg



Modrone wood, gold

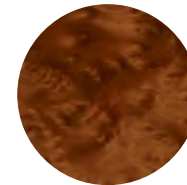

Vavona wood, bronze

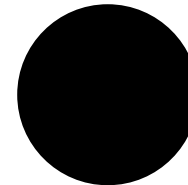

Piano finish, black



Tamo ash, dark brown



Oak, sepia

Options are subject to availability and may extend delivery.

- = Not available
- = Available
- S = Standard

RRP – Recommended Retail Price.

VAT is calculated at 20% but this may alter to reflect any change in the applicable VAT rate.

## Wheels, tyres and suspension

Choose a set of specially-selected alloy wheels to subtly enhance the way your car looks and drives. And you can also specify Audi drive select, which allows you to change suspension and steering settings according to your driving style.



19" x 8.5J '10-spoke' design alloy wheels - PRT



19" x 8.5J '5-arm Y' design alloy wheels - PRV



20" x 9J '7-twin-spoke' polished two-colour design alloy wheels - PQF



20" x 9J '7-twin-spoke' high-gloss design alloy wheels - PQN



20" x 9J '10-parallel-spoke' design alloy wheels - PRC



20" x 9J '5-segment-spoke' design alloy wheels - PQ6

# Wheels, tyres and suspension

Order Code		SE	S line	Basic RRP	Total RRP inc VAT
PRT	19" x 8.5J '10-spoke' design alloy wheels, with 255/40 tyres	●	—	£825.00	£990.00
PRV	19" x 8.5J '5-arm Y' design alloy wheels, with 255/40 tyres	●	—	£825.00	£990.00
PQF	20" x 9J '7-twin-spoke' polished two-colour design alloy wheels with 265/35 R20 tyres	—	●	£2,083.33	£2,500.00
				£833.33	£1,000.00
PQN	20" x 9J '7-twin-spoke' high-gloss design alloy wheels with 265/35 R20 tyres	●	—	£2,500.00	£3,000.00
		—	●	£1,250.00	£1,500.00
PRC	20" x 9J '10-parallel-spoke' design alloy wheels, with 265/35 tyres	●	—	£1,658.33	£1,990.00
PQ6	20" x 9J '5-segment-spoke' design alloy wheels with 265/35 R20 tyres	●	—	£1,791.67	£2,150.00
		—	●	£541.67	£650.00
1BK	<b>Adaptive air suspension</b> – electronically controlled air suspension with infinitely variable adaptive damping system on all 4 wheels; automatically regulates vehicle ride height and damping; includes ride height control; different modes (Comfort, Dynamic, Auto and additional 'Lift' function for increased ground clearance) selected via Audi drive select	●	●	£1,666.67	£2,000.00
GH2	<b>quattro® with Sports differential</b> – the electronically regulated Sports differential distributes variable amounts of driving force to each rear wheel, ensuring outstanding acceleration performance in corners and stabilising the vehicle's response to load change. It also ensures better direct steering characteristics and, thanks to less steering effort, more agile handling. Only available for 3.0 TDI quattro and 3.0 TFSI quattro	●	●	£916.67	£1,100.00
H46	<b>Run-flat tyres</b> – journey can be continued on a flat tyre at a speed of up to 50mph and for a maximum distance of 18 miles, without having to change the wheel. Only available in combination with 19" x 8.5 '10-spoke' design alloy wheels (PRT)	●	—	£262.50	£315.00
1BE	<b>Sports suspension</b> lowered by 10mm with more firmly tuned springs and dampers for more direct contact with the road	●	S	£341.67	£410.00
1BV	<b>S line Sports suspension</b> with more dynamic suspension tuning and vehicle lowered by 10mm (over standard suspension)	—	●	No charge	No charge

Options are subject to availability and may extend delivery.

— = Not available

● = Available

S = Standard

RRP – Recommended Retail Price.

VAT is calculated at 20% but this may alter to reflect any change in the applicable VAT rate.

# Packages

Some items work well together, which is why we've created these special packages. They provide increased convenience and value by combining several of our most popular options.

Options are subject to availability and may extend delivery.

- = Not available
- = Available
- S = Standard

RRP – Recommended Retail Price.

\*Online services are only available for mobile phone contracts including a data option and only within the coverage of the mobile phone network; there may be additional costs for the use of these services (charges and billing correspond to the personal mobile phone contract). Due to high data volumes (currently effects in particular navigation with the help of Google Earth images and WiFi hotspot) a mobile phone contract including a data flat rate is strongly recommended. The content and scope of the online-based services offered may vary.

VAT is calculated at 20% but this may alter to reflect any change in the applicable VAT rate.

Order Code	SE	S line	Basic RRP	Total RRP inc VAT
<p><b>Technology package, featuring MMI navigation Plus with MMI Touch, head-up display and mobile telephone preparation high with online services</b></p> <p><b>MMI Navigation Plus (PNQ)</b> – includes HDD-based Navigation with topographical map display, places of interest and town models in 3D. Destinations can be entered via the speech dialogue system or MMI touch. Also includes DVD player and 2 SDHC memory card readers</p> <p><b>WB4 Head-up display (KS1)</b> – projects driving related information directly into the driver's field of vision using an optical system of mirrors</p> <p><b>Mobile telephone preparation – High with online services (9ZW)</b> – allows a Bluetooth capable mobile phone to connect to the vehicle's internal UMTS module (providing the mobile phone has a sim access profile*). This allows the navigation to use Google Earth images and access Wikipedia See page 40 for more details</p>	•	•	£1,708.33	£2,050.00
<p><b>Comfort package, featuring Audi parking system advanced (rear-view camera), advanced key and electrically adjustable Comfort seats with memory function</b></p> <p><b>Audi parking system advanced (KA2)</b> – uses a rear view camera to display on the MMI unit when reversing. Also includes steering path</p> <p><b>WB1 Advanced key (4F2)</b> – allows the driver to keep their key in their pocket or bag at all times. To unlock and open you simply lift the exterior door handle. The door is locked by pressing the button on the handle</p> <p><b>Electrically adjustable Comfort front seats with memory function (PS8)</b> – the front seats have 18-way electrical adjustment and include a memory function for both front seats and mirrors. Also includes electrically adjustable 4-way lumbar support For more details please see pages 26, 27 and 30</p>	•	-	£1,458.33	£1,750.00



Head-up display – part of technology package



Audi parking system advanced (camera) – part of comfort package



# Audio and communication

Stay in touch using our range of communication functions, and give each journey its own soundtrack with our advanced audio equipment.

Options are subject to availability and may extend delivery.

- = Not available  
• = Available  
S = Standard

RRP - Recommended Retail Price.

\*Online services are only available for mobile phone contracts including a data option and only within the coverage of the mobile phone network; there may be additional costs for the use of these services (charges and billing correspond to the personal mobile phone contract). Due to high data volumes (currently effects in particular navigation with the help of Google Earth images and WiFi hotspot) a mobile phone contract including a data flat rate is strongly recommended. The content and scope of the online-based services offered may vary.

VAT is calculated at 20% but this may alter to reflect any change in the applicable VAT rate.

Order Code		SE	S line	Basic RRP	Total RRP inc VAT
<b>8RY</b>	<b>BOSE® surround sound</b> - 14 speakers including centre speaker in the dashboard and subwoofer in the spare wheel well - 12-channel amplifier with a total output of over 600 Watts - Acoustics specially tuned to the interior - Surround sound 5.1 reproduction (in conjunction with MMI Navigation Plus) and stereo recordings (CD, radio, MP3) - Audiopilot for noise-compensating volume adjustment - Powerful, precise bass reproduction	•	•	£833.33	£1,000.00
<b>8RF</b>	<b>Bang &amp; Olufsen Advanced Sound System</b> - 15 speakers including subwoofer and centre speaker, each with their own amplifier channel for genuine 5.1 surround sound - 10-channel Digital Sound Processing (DSP) full-digital amplifier with a total output of over 1,200 Watts, fully digitised and highly efficient 5-channel ICEPower amplifier for woofers and subwoofer - When switched on, two acoustic lenses extend from the dashboard for excellent sound rendition and perspective from all seats - Polished aluminium speaker covers - Acoustics specially tuned to the interior through the targeted use of tweeters, mid-range speakers and woofers - Speakers in encapsulated housings isolate music and telephone conversations within the vehicle for privacy when making phone calls in handsfree mode - Automatic adjustment of volume to the driving situation Only in combination with MMI Navigation Plus	•	•	£5,250.00	£6,300.00
<b>PNQ</b>	<b>MMI Navigation Plus including MMI Touch.</b> Hard disk navigation with topographical map display, places of interest and town models in 3D. Destinations can be entered via the speech dialogue system or MMI Touch. The system offers 3 alternative routes, with the ability to scroll along the selected route and manoeuvre within the map. Includes split-screen mode for route information, dynamic route guidance (TMC), intersection zoom function, motorway exits and lane recommendations in Driver's Information System. Incorporates MPEG4-compatible DVD player and two SDHC memory card readers (for cards of up to 32GB). Also allows DAB radio to receive DAB+ and DMB audio signals. Adapts lights, transmission and adaptive cruise control (if fitted) to the road conditions - for example, bends in the road, motorways, intersections and urban areas - even when navigation is deactivated	•	•	£979.17	£1,175.00
<b>KS1</b>	<b>Head-up display.</b> An optical system of mirrors projects driving-related information directly into the driver's field of vision. To prevent ghost images, a special windscreen with a wedge-shaped film is fitted. Measuring approx. 26 x 9cm in size, the driver perceives the display to be 2 to 2.5m beyond the windscreen. This display has many benefits: - Helps to increase safety, convenience and driving pleasure - Straightforward operation via MMI - Display is height-adjustable, adjusts to ambient brightness - High resolution of up to 480 x 240 pixels - The following is displayed (depending on chosen option): - road speed - navigation instructions - adaptive cruise control status, distance from vehicle ahead and set speed - warning messages - infotainment lists - speed limit display	•	•	£1,208.33	£1,450.00
<b>9ZW</b>	<b>Mobile telephone preparation - High with online services.</b> A Bluetooth-capable mobile phone can be conveniently connected to the vehicle's internal UMTS module (provided the mobile telephone has a SIM Access Profile. Please note iPhones do not have SIM access profile and therefore a duplicate SIM card would need to be sourced from your network provider and inserted directly into dashboard of the A7). An additional SIM card reader is also located in the surround of the MMI Navigation Plus to allow transfer of phone book entries to the vehicle and management of call lists. Online services through operation of MMI Navigation Plus include: - Point of interest search and navigation with the help of Google Earth images - Weather information - WiFi hotspots for convenient internet access using a mobile end device (e.g. laptop)*. Up to eight end devices can be paired at any one time Can only be ordered in combination with MMI Navigation Plus (PNQ) or as part of the technology package (WB4)	•	•	£350.00	£420.00



# Audio and communication

Order Code		SE	S line	Basic RRP	Total RRP inc VAT
PT4	<b>Mobile telephone preparation – High with online services and cordless handset in the front centre armrest</b> with colour display and integral SIM card reader, for making private phone calls; easy text message entry thanks to automatic word recognition. Only in combination with MMI Navigation Plus	•	•	£816.67	£980.00
7A2	<b>CD changer</b> in the glove compartment, for 6 CDs, MP3 and WMA compatible, shock-resistant, easily accessible and each CD can be loaded and changed individually. Also supports UDF file system (Windows Vista). Music files with digital rights management (DRM) cannot be played. Not available with DVD/CD changer (6G0)	•	•	£366.67	£440.00
6G0	<b>DVD/CD changer</b> in glove compartment, for 6 DVDs or CDs, supports, e.g. audio CDs, video DVDs, MP3, WMA, AAC, MPEG-4 and playlists as well as UDF file system (Windows Vista); supports up to 4,000 tracks per medium; shock-resistant and easily accessible in the glove compartment. Only in combination with MMI Navigation Plus	•	•	£566.67	£680.00
QU6	<b>Digital TV reception and DAB digital radio reception.</b> Reception of digital (DVB-T) uncoded television stations (MPEG-2 standard), TV picture, teletext and Electronic Programme Guide (EPG). Facility to connect 2 external AV sources via adaptor cables (available from Audi Genuine Accessories). Please note: TV reception depends on local digital network availability. No AV or TV video output when driving (audio output available when driving). Only in combination with MMI Navigation Plus (PNQ or WB4)	•	•	£937.50	£1,125.00

Options are subject to availability and may extend delivery.

- = Not available
- = Available
- S = Standard

RRP – Recommended Retail Price.

VAT is calculated at 20% but this may alter to reflect any change in the applicable VAT rate.



MMI Touch

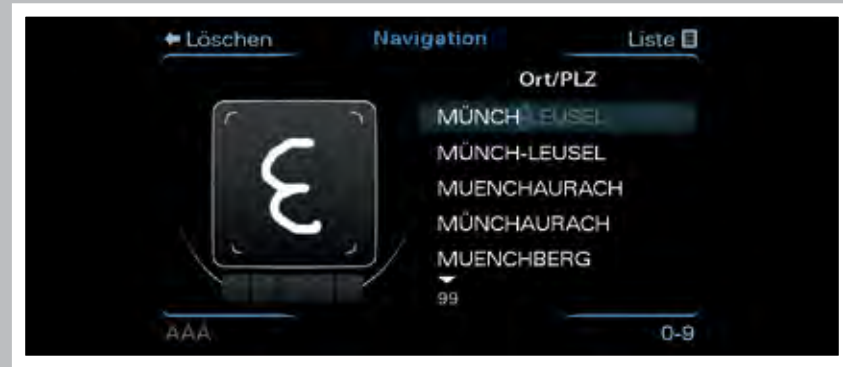

MMI Touch

# Interior equipment

Specify every detail of your car's interior with this range of exclusive options.

Order Code		SE	S line	Basic RRP	Total RRP inc VAT
QQ2	<b>Ambient lighting</b> , including anti-glare illumination for the passenger compartment with LED technology. Lighting for door pockets, footwells and inside door handles, reflected lighting for centre console and door inner panels to help occupants find their way around. Surround lighting for centre console (floating effect), make-up lights at front and active door reflectors, with illuminated door sill trims. Configured via MMI	●	●	£250.00	£300.00
9AQ	<b>Deluxe 4-zone automatic climate control</b> in addition to the standard automatic air conditioning: instead of front control panel with digital display, it has separate temperature control for driver and front passenger sides and for rear passengers; additional air conditioning controls with digital display for climate control in the rear with separately adjustable temperature and blower settings and air distribution for the right and left-hand sides (rear functions can also be set from the front air conditioning controls). It also comes with additional air vents in the B pillars; automatic recirculation mode by means of air quality sensor, use of residual heat, separate regulation of footwell temperature, ventilated glove compartment; choice of 3 settings: gentle, medium, intensive	●	●	£566.67	£680.00
2C7	<b>Electrically adjustable steering column</b> , adjustable for height and reach with auto easy-entry and exit function	●	●	£350.00	£420.00
6NQ	<b>Cloth headlining</b> – black, only available in combination with interior colours FZ or VB	●	S	£225.00	£270.00
PAC	<b>Storage pack</b> including tie-down straps consisting of 2 drinks holders in the rear centre armrest, luggage net for luggage compartment and two 12-Volt sockets in the rear	●	●	£87.50	£105.00
7HB	<b>Extended leather package</b> with lower part of centre console, armrests in the doors, door pull handles in leather	●	●	£566.67	£680.00
6SJ	<b>Reversible luggage compartment mat</b> , for luggage compartment, velour on one side, rubber on the other, folds out to cover the luggage compartment, even with the rear seats folded down	●	●	£91.67	£110.00
3X2	<b>Through-load facility with removable ski/snowboard bag</b> , for practical and safe transportation of long objects, e.g. up to 4 pairs of skis or 2 snowboards; unrestricted use of the rear seats	●	●	£175.00	£210.00
3Y6	<b>Manual blind for rear window</b>	●	●	£112.50	£135.00
9JC	<b>Smoking package</b> (cigarette lighter and ashtray)	●	●	No charge	No charge
YSQ S3G	<b>Audi exclusive carpets</b> – also includes 4 Audi exclusive floor mats with leather piping. Cannot be combined with option YSR/S3G – Audi exclusive floor mats	●	●	£1,750.00	£2,100.00
YSR S3G	<b>Audi exclusive floor mats with leather piping</b> – also includes 4 floor mats for front and rear. Cannot be combined with option YSQ/S3G – Audi exclusive carpets	●	●	£395.83	£475.00
YTO S3G	<b>Audi exclusive seat belts</b>	●	●	£1,375.00	£1,650.00

Options are subject to availability and may extend delivery.

– = Not available  
● = Available  
S = Standard

RRP – Recommended Retail Price.

VAT is calculated at 20% but this may alter to reflect any change in the applicable VAT rate.



# Exterior equipment

Make sure your car looks exactly as you want it to by selecting some of our striking options.

Order Code		SE	S line	Basic RRP	Total RRP inc VAT
6XF	Exterior mirrors with memory function, heated, electrically adjustable and electrically folding	●	●	£195.83	£235.00
6XM	Exterior mirrors with memory function, heated, electrically adjustable and auto-dimming	●	●	£229.17	£275.00
6XL	Exterior mirrors with memory function, heated, electrically adjustable, electrically folding and auto-dimming	●	●	£429.17	£515.00
GZ2	Power door closure. Automatically pulls doors that are not completely engaged into the lock	●	●	£516.67	£620.00
4KF	<b>Privacy Glass. Dark tinted rear and rear-side windows (from B pillar backwards)</b> - Windscreen in heat/sound insulating glass - Front side windows in standard glass (single layer safety glass) with privacy glass - Rear side windows in standard glass (single layer safety glass) with privacy glass - Rear window in standard glass (single layer safety glass) with privacy glass	●	●	£395.83	£475.00
PDW	<b>Heat/Sound insulating glass with privacy glass</b> - Windscreen in heat/sound insulating glass with visible vehicle identification number - Front side windows in heat/sound insulating glass - Rear side windows in standard glass (single layer safety glass) with privacy glass - Rear window in standard glass (single layer safety glass) with privacy glass	●	●	£708.33	£850.00
PDV	<b>Heat/Sound insulating glass</b> - Windscreen in heat/sound insulating glass with visible vehicle identification number - Front side windows in heat/sound insulating glass - Rear side windows in heat/sound insulating glass - Rear window in standard glass (single layer safety glass)	●	●	£875.00	£1,050.00
3FE	Slide-and-tilt sunroof with tinted single-glazed safety glass and infinitely adjustable sun shield, integral wind deflector, convenient closing from outside via the central locking and the radio-operated remote control	●	●	£987.50	£1,185.00
1D4	Towing bar. Ball head and ball joint coupling made from forged steel. Mechanically swivelling ball head, operated via Bowden cable, with indicator light on Bowden cable and display in instrument cluster to monitor secure attachment of trailer towing hitch; includes trailer stabilisation system via the Electronic Stability Programme (ESP)	●	●	£854.17	£1,025.00
2Z0	Deletion of model designation, engine technology and quattro® badges at rear	●	●	No charge	No charge
2Z7	Deletion of model designation and quattro® badges at rear	●	●	No charge	No charge

Options are subject to availability and may extend delivery.

- = Not available
- = Available
- S = Standard

RRP – Recommended Retail Price.

VAT is calculated at 20% but this may alter to reflect any change in the applicable VAT rate.



# Safety and security

Intelligent technology designed to give you better all-round awareness and safety on the road.

Options are subject to availability and may extend delivery.

- = Not available
- = Available
- S = Standard

RRP – Recommended Retail Price.

VAT is calculated at 20% but this may alter to reflect any change in the applicable VAT rate.

\*Where the law permits

Order Code		SE	S line	Basic RRP	Total RRP inc VAT
PCB	<p><b>Audi active lane assist</b> helps the driver to stay in lane with gentle steering impulses for greater safety and convenience, particularly on motorways and country roads:</p> <ul style="list-style-type: none"> <li>- Informs driver if car is drifting out of lane unintentionally above approx. 37mph</li> <li>- Driver has the choice of two system settings in the MMI:                             <ul style="list-style-type: none"> <li>- early steering intervention: continuously helps the driver to stay in lane with steering impulses that centre the vehicle in its lane</li> <li>- late steering intervention: alerts the driver that the vehicle is possibly crossing the lane markings at the same time as providing a corrective steering prompt</li> </ul> </li> <li>- Additional warning via vibrating steering wheel when lane markings are crossed, if specified by driver</li> <li>- Camera identifies individual or coloured lane markings, e.g. yellow lines at roadworks</li> <li>- Additional indication in head-up display (if selected as an option)</li> </ul>	•	•	£479.17	£575.00
7W1	<p><b>Pre-sense basic</b> networks the different vehicle systems, enabling driving situations to be categorised and, where necessary, actions to be implemented to protect passengers. These include: belt tightening, activating the hazard warning system and closing the windows and – if fitted – sliding roof</p>	•	•	£216.67	£260.00
PCG	<p><b>Adaptive cruise control (ACC) with Stop&amp;Go function including pre-sense front.</b> Automatic distance regulation, using radar sensors to maintain required distance by braking and accelerating. Four programs (distance 1 to distance 4) set via steering column controls of the cruise control system. Works at speeds between 0 and 155mph* and also includes Audi braking guard – system which triggers a visual and acoustic alarm when it detects the risk of a rear end collision with the vehicle in front. In addition, the airbags are pre-conditioned if a crash is sensed and the braking system is prepared to assist with the necessary braking force once the brake pedal is touched</p>	•	•	£1,500.00	£1,800.00
PCB	<p><b>Audi side assist including pre-sense rear.</b> Aids the driver when changing lane. Audi side assist monitors the area behind your car, using radar sensors located discreetly in the rear bumper, informing the driver with a visual warning signal in the door mirror if there is a vehicle in their blind spot or approaching quickly from behind. The system is activated using a button in the driver's door and works at speeds above 19mph. If a rear collision is sensed, the upper backrest and headrest are adjusted automatically (where memory seats are fitted) to provide more protection. If Comfort front seats or Comfort front Sports seats are also selected the pneumatic bolsters are filled to provide extra protection. In addition, the airbags are pre-conditioned. Only available with electrically folding mirrors (6X1/F)</p>	•	•	£437.50	£525.00

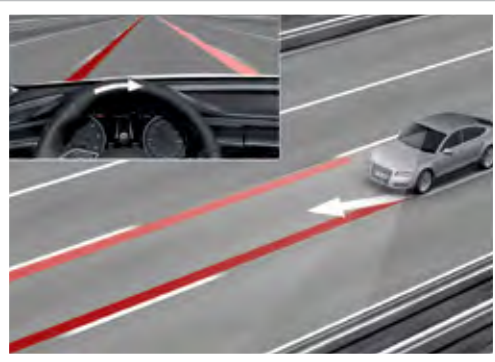

Audi active lane assist



Adaptive cruise control with pre-sense front

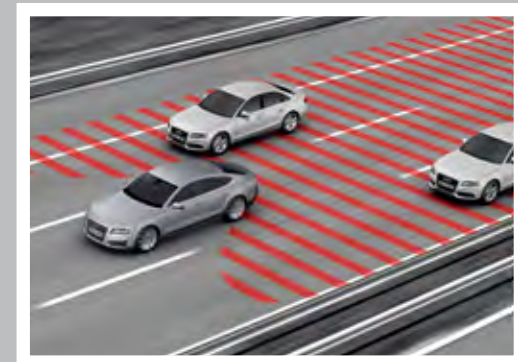

Audi side assist including pre-sense rear

# Safety and security

Order Code		SE	S line	Basic RRP	Total RRP inc VAT
PCN	<b>Audi adaptive cruise control with Stop&amp;Go function, Audi side assist and Audi active lane assist with pre-sense plus.</b> Only in combination with electrically folding door mirrors (6XL/F)	●	●	£2,166.67	£2,600.00
PCD	<b>Audi side assist including pre-sense rear and active lane assist.</b> Only in combinations with electrically folding door mirrors (6XL/F)	●	●	£916.67	£1,100.00
QR9	<b>Speed limit display</b> the current speed limit can be seen on the Driver's Information System (DIS). Should the camera fail to see a sign properly, the speed limit from the data for the navigation system – if fitted – will be shown instead. The specific advantages: - Display of the speed limits currently registered, which can be called up in the Driver's Information System at any time - Display can be called up in every instrument cluster view and in the head-up display (optionally available) - Camera-based system is also capable of detecting temporary speed restrictions in roadworks and on digital displays (e.g. over motorways) within the system limits - Display of national speed limits for Western European countries Only available in conjunction with MMI Navigation Plus (PNQ), and with active lane assist (PCB), Audi side assist (PCD), or adaptive cruise control (PCG/PCN)	●	●	£129.17	£155.00
4X4	<b>Rear side airbags</b> , for the outer rear seats, incorporated into the seat backrests; supplement the side impact protection in the doors and the head airbag system	●	●	£312.50	£375.00
1T3	<b>First aid kit</b> in the storage compartment of the rear centre armrest	●	●	£25.00	£30.00
VC1	<b>Garage door opener (HomeLink®*)</b> , programmable radio-operated remote control for compatible doors/gates. Control buttons integrated in the front roof module	●	●	£204.17	£245.00
4F2	<b>Advanced key.</b> Access and authorisation system that works through automatic data exchange between key and vehicle, allowing the driver to keep their car key in their pocket or bag at all times. To unlock and open, simply lift the exterior door handle. The door is locked by pressing the button on the handle. Pressing the start/stop button integrated in the centre console starts and stops the engine	●	●	£566.67	£680.00
8N7	<b>High-beam assist</b> variable headlight range control featuring a camera on the interior mirror which registers sources of light from other road users. The range and width of the headlight beam are continuously varied between dipped and main beam to suit ambient conditions, ensuring that the headlights provide good visibility without dazzling other road users	●	●	£116.67	£140.00

Options are subject to availability and may extend delivery.

\*Homelink® is a registered trademark of Johnson Controls. For information on compatibility, visit [www.homelink.com](http://www.homelink.com).

- = Not available  
● = Available  
S = Standard

RRP – Recommended Retail Price.

VAT is calculated at 20% but this may alter to reflect any change in the applicable VAT rate.

# Safety and security

Intelligent technology designed to give you better all-round awareness and safety on the road.

Options are subject to availability and may extend delivery.

- = Not available
- = Available
- S = Standard

RRP – Recommended Retail Price.

VAT is calculated at 20% but this may alter to reflect any change in the applicable VAT rate.

Order Code		SE	S line	Basic RRP	Total RRP inc VAT
PXB	<b>Adaptive light and high-beam assist.</b> Automatically adjusts headlights from high-beam to dipped-beam when another vehicle is approaching or when other ambient lighting is detected (i.e. street lights). Also includes swivelling headlights for improved illumination of a winding road, and dynamic cornering light function. Kerb-light function is activated when indicator is switched on, steering wheel is turned considerably or 'reverse' is selected. Only works with low-beam headlights and at speeds up to 45mph. Not available in combination with all-LED headlights (PX2)	•	•	£575.00	£690.00
PX2	<b>LED headlights including adaptive light and high-beam assist.</b> LEDs for all front lighting functions; includes main beam assist for automatic switching between main and dipped beams, an all-weather light function to reduce the risk of the driver being dazzled when visibility is poor (in fog, rain or snow) and an additional motorway light which automatically increases headlight range at speeds above approximately 68mph; LED technology allows near daylight illumination of the road for increased safety and comfort; minimal energy requirements, long service life, and particularly good recognition by other road users	•	•	£1,416.67	£1,700.00
9R1	<b>Night vision assistant with pedestrian detection.</b> A thermal imaging camera (remote infrared with resolution of 320x240 pixels) registers heat dissipation in front of the vehicle and represents this image in the Driver's Information System (DIS). Image recognition software highlights people detected in the darkness and a warning bell is sounded if the system classifies them as being at risk. System operation may be restricted in too much ambient light, high humidity and high night temperatures (over 28 degrees)	•	•	£1,750.00	£2,100.00
7X5	<b>Park assist</b> searches for suitable parking spaces along the road by means of ultrasonic sensors, calculates the ideal parking path and performs the steering action virtually automatically. Steering is done by the vehicle – the driver just needs to accelerate and apply the brakes	•	•	£341.67	£410.00
KA2	<b>Audi parking system advanced (rear-view camera)</b> – image of area behind the vehicle is shown on the MMI display, with dynamic display modes showing the calculated path (steer-angle dependent); includes guidelines and shows where to apply opposite lock when parallel parking. Reversing camera is concealed in the handle strip of the tailgate	•	•	£391.67	£470.00

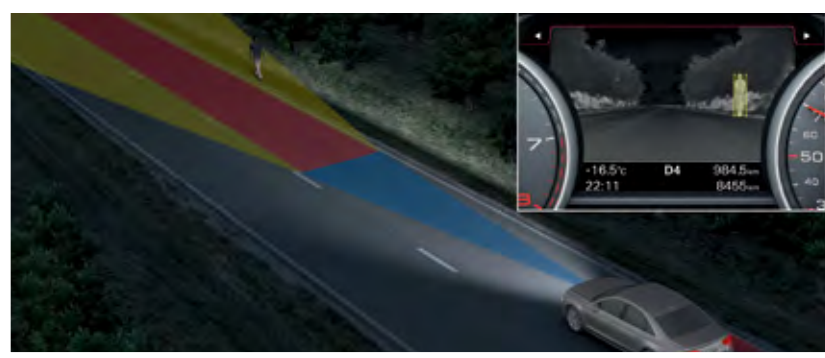

Night vision assistant with pedestrian detection



LED headlights



# Steering wheels

Order Code		SE	S line	Basic RRP	Total RRP inc VAT
2ZM	4-spoke leather-trimmed multi-function steering wheel – heated (no paddles)	●	–	£33.33	£40.00
1XX	3-spoke leather-trimmed multi-function Sports steering wheel – with paddles	●	S	£95.83	£115.00
1XT	3-spoke leather-trimmed multi-function Sports steering wheel – heated and with paddles	●	–	£262.50	£315.00
		–	●	£166.67	£200.00
6F9	Steering wheel in wood segment design. Only in conjunction with leather-covered multi-function steering wheel in 4-spoke design with shift paddles and wood inlays in Walnut dark brown. Not in combination with Audi exclusive wood inlays or Audi active lane assist	●	–	£508.33	£610.00
YRH S3G	Audi exclusive leather-covered steering wheel. Available on 3-spoke or 4-spoke steering wheels. Not available in conjunction with Audi exclusive controls package (YRB/S3G)	●	●	£458.33	£550.00
YRB S3G	Audi exclusive controls package – includes leather-covered steering wheel and selector lever. Not available in conjunction with Audi exclusive leather-covered steering wheel (YRH/S3G)	●	●	£691.67	£830.00
YTD	Audi exclusive wood gear lever knob. Only available in conjunction with wood inlays	●	●	£270.83	£325.00

Options are subject to availability and may extend delivery.

- = Not available
- = Available
- S = Standard

RRP – Recommended Retail Price.

VAT is calculated at 20% but this may alter to reflect any change in the applicable VAT rate



## Service Plan

Choosing an Audi Service Plan provides an easy way to cover all your car's scheduled servicing with a convenient monthly payment plan. It can take care of everything from fluid and filter changes to your full service, ensuring you retain a full Audi service history. There are no servicing bills to plan for and you'll continue to benefit from today's prices for the length of your agreement.

Order Code		SE	S line	Basic RRP	Total RRP inc VAT
-	<b>3-Service Plan.</b> Comprehensive package covering servicing costs for 3 services or 30,000 miles (whichever occurs sooner). Visit <a href="http://audi.co.uk/serviceplans">audi.co.uk/serviceplans</a> for full details including terms and conditions	●	●	£33.33	£40.00
-	<b>5-Service Plan.</b> Comprehensive package covering servicing costs for 5 services or 50,000 miles (whichever occurs sooner). Visit <a href="http://audi.co.uk/serviceplans">audi.co.uk/serviceplans</a> for full details including terms and conditions	●	●	£41.67	£50.00

## Warranty

Order Code		SE	S line	Basic RRP	Total RRP inc VAT
-	<b>Audi Warranty,</b> covering you for unlimited mileage in the first two years of ownership, and up to 60,000 miles in the third year. Transferable between owners**	S	S	No charge	No charge
EA6	<b>Audi Warranty,</b> covering you for up to 4 years or 75,000 miles, whichever comes soonest. Cover includes a two-year unlimited mileage warranty, and up to 75,000 miles in the third and fourth years. Transferable between owners**	●	●	£608.33	£730.00
EA9	<b>Audi Warranty,</b> covering you for up to 5 years or 90,000 miles, whichever comes soonest. Cover includes a two-year unlimited mileage warranty, and up to 90,000 miles in the third, fourth and fifth years. Transferable between owners**	●	●	£1,458.33	£1,750.00

Options are subject to availability and may extend delivery.

- = Not available  
● = Available  
S = Standard

\*Prices are based on the Audi Fixed Inspection Service Schedule and 10,000 miles per annum or less. For more information on the Service Schedule, please see page 55.

\*\*Only available when ordering your new A7. Please speak to your Audi Centre for full details.

RRP – Recommended Retail Price.

VAT is calculated at 20% but this may alter to reflect any change in the applicable VAT rate.

# Merchandise

From the enthusiasts' motorsport collection to the sophisticated Audi collection, there's a wide variety of adults' and children's clothing, lifestyle accessories and collectables, all of which bear the Audi name.

Please speak to a member of our team at your local Audi Centre to see the full Audi collection and to place an order. A selection of Audi merchandise is also available to buy from [audi.co.uk/merchandise](http://audi.co.uk/merchandise).



Audi kids



Bags and leather goods



Clothing



Motorsport



Sport and travel



Model cars

# Accessories

Choosing an Audi isn't just a matter of deciding on the model you want; it's about creating a car that suits your needs perfectly. And that's why we've developed a whole range of accessories to enhance your A7, enabling you to customise it down to the last detail. Like your Audi, all these accessories are developed to the highest possible standards. And they're all available exclusively from Audi. To find out more, just visit your local Audi Centre.

## Warranty

All of the accessories available on the A7 are covered by a three-year warranty\* if they are ordered and included in the purchase price of the car at date of delivery. Any accessories ordered and installed after delivery include a two-year warranty.\*



Sport and design



Transport and touring



Entertainment and communication

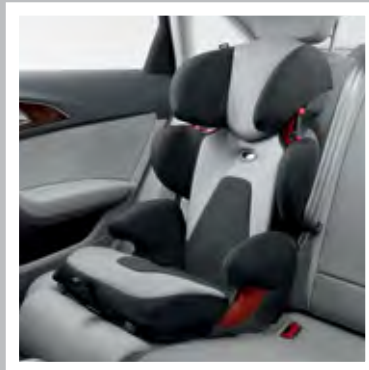

Family

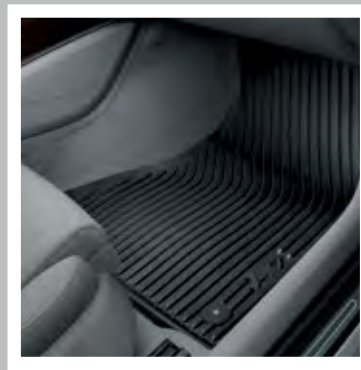

Comfort and protection



Safety and security

\*Excluding Road Angel products.

Audi Accessories warranty terms and conditions can be found at [audi.co.uk](http://audi.co.uk)

# A7 Sportback technical data

## Petrol

Engine	2.8 FSI quattro	3.0 TFSI quattro
Transmission	7-speed S tronic	7-speed S tronic
Cylinder	6	6
Displacement, cubic cm (valves per cylinder)	2773	2995
Max. power, <sup>1</sup> PS	204/5250-6500	300/5250-6500
Max. torque, Nm at rpm	280/3000-5000	440/2900-4500
0-62mph acceleration, seconds	8.3	5.6
Top speed, mph	146	155*
CO <sub>2</sub> emissions, <sup>2</sup> g/km	187	190
Benefit in kind (BIK)%	27%	28%
Fuel consumption, mpg (l/100km) Urban	26.4 (10.7)	26.2 (10.8)
Fuel consumption, mpg (l/100km) Extra Urban	43.5 (6.5)	42.8 (6.6)
Fuel consumption, mpg (l/100km) Combined	35.3 (8.0)	34.4 (8.2)
ABI insurance group 1-50 <sup>+</sup>	33 E	40 E
Unladen weight, <sup>3</sup> kg	1730	1785
Gross weight limit, kg	2340	2395
Roof load limit/nose weight, kg	100/85	100/85
Max trailer load unbraked, <sup>4</sup> kg	750	750
Max trailer load with 12% gradient, <sup>4</sup> kg	1900	2100
Max trailer load with 8% gradient, <sup>4</sup> kg	2100	2100
Luggage compartment capacity, rear seats upright, litres	535	535
Luggage compartment capacity, rear seats folded, litres	1390**	1390**
Fuel tank capacity approx, litres	65	65

\*Electronically limited

\*\*Loaded up to roof with rear seat folded down.

<sup>+</sup>Highest insurance group rating shown. Group may be lower dependent on trim level. Please visit [www.thatcham.org/abigrouprating](http://www.thatcham.org/abigrouprating) for details.

<sup>1</sup>The given value was obtained in accordance with the specified measurement procedure (the respective current version of the Directive 80/1269/EEC).

<sup>2</sup>The given values were calculated in accordance with the specified measurement procedure (the respective current version of Directive 80/1268/EEC). This information does not relate to a single vehicle and does not comprise part of the offer but is merely intended for the purpose of comparison between the different vehicle types.

<sup>3</sup>Vehicle's unladen weight without driver (calculated in accordance with the current version of Directive 80/1268/EEC). The fitting of additional equipment may increase the vehicle's unladen weight and drag coefficient, whereupon the potential carrying capacity and top speed will be correspondingly reduced.

<sup>4</sup>The engine's power output always goes down with increasing altitude. At 1,000m above sea level, and for every additional 1,000m, deduct 10% from the weight of the outfit (trailer load limit + gross weight of the towing vehicle).

**Please note:** The maximum power output figures are quoted in PS (or Pferdestärke, which is the metric equivalent of brake horsepower). To convert to brake horsepower, divide the PS figure by 1.0139.

## Diesel

Engine	3.0 TDI	3.0 TDI quattro
Transmission	8-speed multitronic	7-speed S tronic
Cylinder	6	6
Displacement, cubic cm (valves per cylinder)	2967	2967
Max. power, <sup>1</sup> PS	204/3750-4500	245/4000-4500
Max. torque, Nm at rpm	400/1250-3500	500/1400-3250
0-62mph acceleration, seconds	7.4	6.3
Top speed, mph	146	155*
CO <sub>2</sub> emissions, <sup>2</sup> g/km	135	156
Benefit in kind (BIK)%	20%	24%
Fuel consumption, mpg (l/100km) Urban	47.9 (5.9)	39.2 (7.2)
Fuel consumption, mpg (l/100km) Extra Urban	60.1 (4.7)	54.3 (5.2)
Fuel consumption, mpg (l/100km) Combined	55.4 (5.1)	47.9 (5.9)
ABI insurance group 1-50 <sup>+</sup>	33 E	40 E
Unladen weight, <sup>3</sup> kg	1695	1785
Gross weight limit, kg	2305	2395
Roof load limit/nose weight, kg	100/85	100/85
Max trailer load unbraked, <sup>4</sup> kg	750	750
Max trailer load with 12% gradient, <sup>4</sup> kg	1800	2000
Max trailer load with 8% gradient, <sup>4</sup> kg	1900	2100
Luggage compartment capacity, rear seats upright, litres	535	535
Luggage compartment capacity, rear seats folded, litres	1390**	1390**
Fuel tank capacity approx, litres	65	65

# A7 Sportback dimensions

The technical drawings opposite show the exact dimensions of the Audi A7 Sportback, so you can check everything – from whether the car will fit in your garage to whether your luggage will fit in the boot.

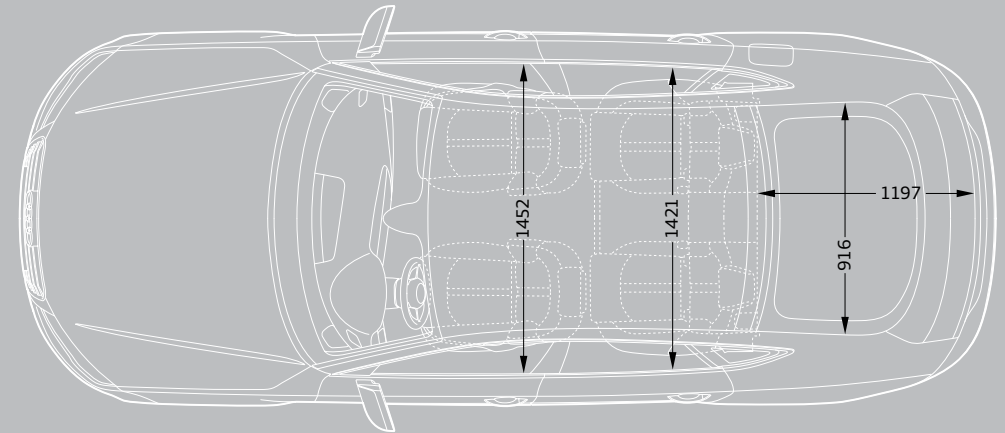
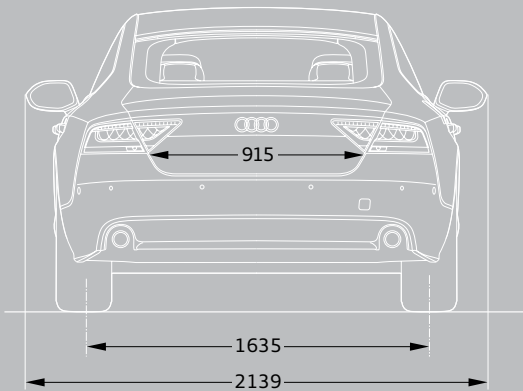
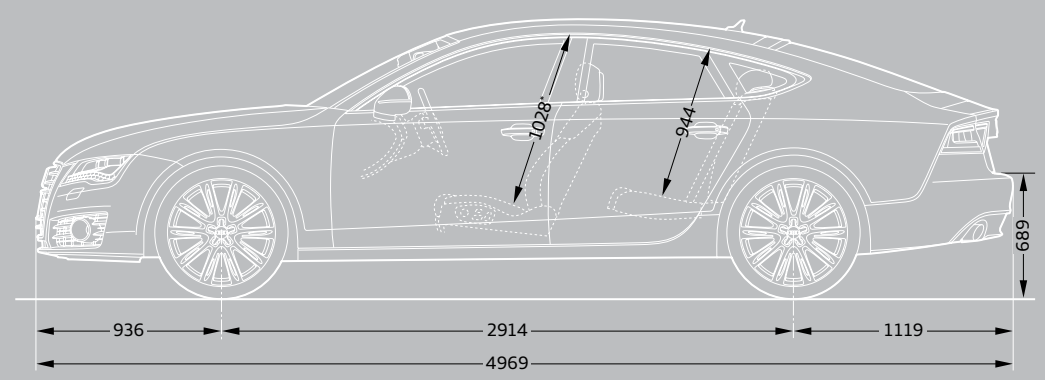
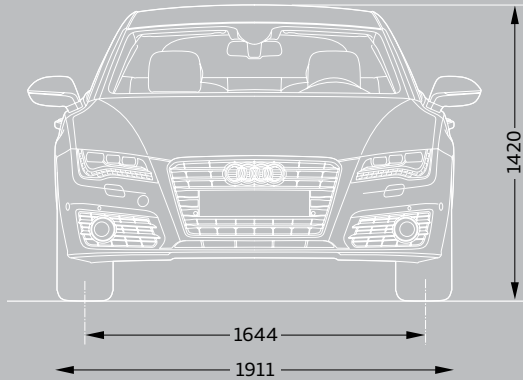

\*Maximum headroom.

Dimensions in millimetres.

Turning circle approx 11.9m.

Dimensions were measured with vehicle at unladen weight. Luggage compartment volume in litres: 535/1390 (measured by the VDA standard test method using 200 x 100 x 50mm blocks; second value: with rear seat folded down).

# Additional information

## CO<sub>2</sub> data and information

### CO<sub>2</sub> emissions-based Vehicle Excise Duty

Vehicle Excise Duty (Road Fund Licence) is based upon the amount of Carbon Dioxide (CO<sub>2</sub>) a vehicle emits, measured in grams per kilometre (g/km). First year VED rates apply to the first year of ownership. Annual VED rates apply thereafter. The DVLA has created thirteen categories:

Petrol and Diesel engines	First year	Annual rate (second year onwards)
A – up to 100g/km	£0.00	£0.00
B – 101 to 110g/km	£0.00	£20.00
C – 111 to 120g/km	£0.00	£30.00
D – 121 to 130g/km	£0.00	£95.00
E – 131 to 140g/km	£115.00	£115.00
F – 141 to 150g/km	£130.00	£130.00
G – 151 to 165g/km	£165.00	£165.00
H – 166 to 175g/km	£265.00	£190.00
I – 176 to 185g/km	£315.00	£210.00
J – 186 to 200g/km	£445.00	£245.00
K – 201 to 225g/km	£580.00	£260.00
L – 226 to 255g/km	£790.00	£445.00
M – over 255g/km	£1,000.00	£460.00

Vehicle Excise Duty (VED) rates correct at time of going to print, but these may alter to reflect any change in the applicable VED rate

### Servicing tailored to your needs

Regular servicing is key to safeguarding your Audi's performance and a full Audi service history could help you preserve the future re-sale value. To make servicing easy, the Audi Service Schedules have been designed to work with your individual driving style and vehicle.

There are two schedules available and your Audi Centre will advise which schedule is most suited to your needs. The conventional fixed Audi Inspection Service Schedule has fixed intervals for the Oil-change and Inspection Service that are based on time

and distance, whichever comes first. With the Audi LongLife Service Schedule, sensors take account of driving style and conditions in which the vehicle is used to indicate when the Oil-change Service is required. Oil-change Service intervals are therefore variable and are conveniently indicated via the on-board service interval display.

#### Fixed Inspection Service Schedule

	Vehicle usage:
Mileage	Less than 10,000 miles per annum
Type of journey	Mainly city/town centre driving. Short journeys
Conditions	Frequent cold starts. High engine loading – e.g. frequent hill climbs, vehicle fully loaded, towing
Driving style	Uneconomical – e.g. heavy acceleration, heavy braking, constant changes in speed, constant use of high revs, 'sporty' driving
	Service Intervals:
Oil-change Service	Fixed to every 9,000* miles/1 year
Inspection Service	Fixed to every 19,000* miles/2 years

#### Variable LongLife Service Schedule

	Vehicle usage:
Mileage	More than 10,000 miles per annum
Type of journey	Motorway and main road driving. Mainly longer distance journeys. Constant speeds
Conditions	Normal engine loading – e.g. with little or no towing, with little or no hill climbs. Normal vehicle loading
Driving style	Moderate acceleration, moderate braking, engine revs mainly below 3,000
	Service Intervals:
Oil-change Service	Variable to a maximum of every 19,000* miles/2 years
Inspection Service	Fixed to every 19,000* miles/2 years

\*As indicated by the service interval display. Mileages are approximate as the Service Indicator system uses kilometres as its distance measurement.

# Additional information

## Welcome to Audi

By placing an order for your Audi, you're choosing to get behind the wheel of one of the most sophisticated cars on the road. And because we believe the service we offer should be just as advanced, we wanted to let you know exactly what you can expect from us, now and in the future.

We've agreed a set of standards with all our Centres, which governs the way we do business with you. It outlines the kind of service we promise to deliver for every customer, right down to filling each new Audi we sell with half a tank of fuel.

So whether you're interested in the date your car will arrive in the UK or the way we'll dispose of non-biodegradable materials after we service your Audi, you can have total confidence in us.

## Audi Promise

### Audi Centres

We guarantee that all of our Centres will be open as follows:

Sales: Monday to Friday 9am–6pm  
Saturday 9am–5pm

Service: Monday to Friday 8am–6pm  
Saturday 8.30am–1pm

Sunday opening is at local discretion.

### New car delivery

Once we've confirmed a delivery date for your car, we'll keep you informed of progress. Subject to reasonable notice, we'll then deliver it to a place of your choice, whether that's your home or place of work. In the unlikely event of a delay, we'll provide a courtesy car to minimise inconvenience and keep you mobile.

### The experts in Vorsprung durch Technik

Would you entrust your Audi to anyone who hasn't been regularly trained to Audi standards? Our network of Audi Approved Master Technicians have undergone an impressive 100,000 hours of training over a 10-year programme to ensure they have the latest technical expertise for maintaining and servicing your Audi. All of our Service Advisors undergo a specialist induction and training to ensure they are Audi professionals and able to talk to you about any issues you may have with your Audi vehicle. What's more, we have so much expertise and experience in looking after Audi vehicles that we are able to make a note of your mileage and the state of your vehicle as and when we see it and predict when certain key events may occur. As part of our commitment to you, we will notify you in plenty of time so you can make an appointment with us.

### Your convenience comes first

At Audi you can choose from a range of convenient services that suit your needs. Why not book a 'service while you wait' appointment\* and enjoy our complimentary refreshments while your car is with us? Or, if you need to be mobile, take advantage of one of our courtesy cars which we can even collect and deliver to you.\* We guarantee we can service your Audi within 5 days without a courtesy car, or within 10 days if you need transport. We will also ensure your car is returned to you with a full valet.

### Audi Genuine Parts

Would you put a part into your Audi that wasn't the same quality as the factory fitted original? You can rest assured that only Audi Genuine Parts will be used on your vehicle. What's more, Audi parts and labour come with a 2-year guarantee.\*\* We stock a wide variety of parts, so we are well covered. However, if we don't have a part in stock at our Centre we have the back-up of parts at other Audi Centres, at our national warehouse and our factory and can usually source the relevant part very quickly.

### We don't like surprises either

We believe strongly in transparency and there will be no hidden costs. For added peace of mind, we will give you a quotation over the phone for the work you have requested and email you the price confirmation. We'll consult you if any additional work on your car is needed when it is with us. We won't carry out any extra work without asking your permission first.

### The Audi Stamp

Regular servicing is key to safeguarding your Audi's performance and a full Audi service history could help you preserve the future re-sale value of your car. Only the Audi Stamp will prove your approved Audi service history.

### Getting better every time

We continually gather feedback from our Audi Trained Technicians, as well as our customers, to ensure our vehicles are running as they should. Whenever we see an Audi for a service, we connect it directly to our headquarters in Ingolstadt which enables us to check your car's software and make sure it's as up-to-date as possible. If the factory has released a software upgrade for your model, it can be applied immediately – improving anything from your car's efficiency to the precision of its parking system.

### Environmental commitment

We promise to dispose of all non-biodegradable materials from your vehicle in a responsible manner

\*Subject to availability.

\*\*Excludes wear and tear.



# Pricing information

## Pricing

Prices and specifications given are correct at the time of printing. Always check details with your Audi Centre, as Audi policies are continually developing. We reserve the right to change prices or specifications at any time.

All prices are subject to VAT, currently charged at 20% but this may alter to reflect any change in the applicable VAT rate.

Delivery charges and number plates are not included in the vehicle price.

Delivery charge	£471.66
Number plate	£20.00
VAT	£98.34
Total	£590.00

## Audi Roadside Assistance

Your new car comes complete with 3 years' complimentary roadside assistance and recovery across the UK provided by RAC Motoring Services. Also included is roadside assistance throughout Europe, managed by RAC Motoring Services. For further information and terms conditions please visit [audi.co.uk](http://audi.co.uk)

## Audi Customer Care

Every new Audi benefits from the comprehensive Audi Customer Care Package, which comprises:

- ▶ A 3-year Audi warranty, which covers you for unlimited mileage in the first 2 years of ownership, with a full mechanical and electrical warranty which covers you for up to 60,000 miles in the 3rd year

- ▶ A 3-year paint warranty
- ▶ A 12-year anti-corrosion warranty
- ▶ 3 years' UK roadside assistance and recovery

You also have the option when ordering your new car of choosing a 4-year or 5-year Audi warranty. Speak to a member of the sales team for more information.

## Audi Tax-Free Sales

If you are entitled to purchase a vehicle free of VAT, normally through Military or Diplomatic privilege, please contact your local Audi Centre for full details.

Should you have any difficulty obtaining the information you require, please call Freephone 0800 585878.

## Audi Finance

Audi Finance specialise in providing funding solutions for Audi drivers. Whether your Audi is for private or business use, there is a range of funding options to choose from.

Below is the full range of finance products.

- ▶ Solutions – a Personal Contract Plan
- ▶ Hire purchase
- ▶ Lease purchase
- ▶ Finance lease
- ▶ Contract hire

With all products, you can choose a fixed-cost maintenance plan designed to help you budget accurately.

No matter what Audi model you choose, your local Audi Centre can provide you with a personalised quote which could fit your budget and motoring needs.

Audi Finance is a trading name of Volkswagen Financial Services (UK) Limited. An offer of finance depends on certain conditions. Available to people over 18 in the UK only.

## Audi Insurance

We want you to start enjoying your new car from day one and thanks to Audi Insurance complimentary seven day cover, you can.

Call free on 0800 316 7893 (lines are open Monday to Friday 8am - 9pm, and Saturday 9am - 5pm), provide a few details and a cover note will be sent to your Audi Centre. They will then tax your car and you can drive it away.

Audi Insurance is a trading name of Volkswagen Insurance Service (Great Britain) Limited, an appointed representative of Volkswagen Financial Services (UK) Limited, Brunswick Court, Yeomans Drive, Blakelands, Milton Keynes MK14 5LR. Registered in England number 2835230. Audi Insurance is sold, underwritten and administered by Allianz Insurance plc registered in England number 84638. Registered office 57 Ladymead, Guildford, Surrey GU1 1DB. Volkswagen Financial Services (UK) Limited and Allianz Insurance plc are authorised and regulated by the Financial Services Authority. Volkswagen Financial Services (UK) Limited and Allianz Insurance plc are not part of the same corporate group.



**Audi UK**

Customer Services  
Selectapost 29  
Sheffield  
S97 3FG  
0800 699888  
audi.co.uk

Specifications and prices subject  
to change without notice.

© Audi (UK)

Printed in the UK  
Edition 3.0 05/11  
2012 Model Year

Images are for illustrative purposes only.