



## The Audi Q7

Pricing and Specification Guide  
Valid from September 2012



# Personalising your Audi Q7

This guide has been designed to help you tailor and price your Audi Q7 quickly and logically. At the back, you will find information on CO2 emissions-based taxation and the other services offered by Audi, including Finance and Insurance. You can also configure your Audi Q7 online at [audi.co.uk](http://audi.co.uk).

You might also like to consider Audi Complete: a simple way to take care of servicing and maintenance costs for your Audi in a single package. You pay a one-off or monthly fee and we'll cover all your servicing, maintenance and tyres for the next three years including your first MOT. It means you only have to pay for fuel, insurance and your Road Fund Licence. So you can be reassured that your car will be maintained by trained Audi Technicians, using genuine Audi parts.

**Audi Complete™**

## The Audi Q7

Engines	12
Transmission	13
Efficiency	14
quattro®	16

## Model details and prices

Standard model equipment	20
SE model equipment	22
S line model equipment	24
S line Plus model equipment	26
Model prices	28

<b>Audi exclusive</b>	30
-----------------------	----

## Colour and upholstery

Paint	34
Upholstery	38
Colour and trim guide	44
Inlays	50

## Options

Wheels and tyres	54
Packages	58
Audio and communication	60
Interior equipment	62
Seats	64
Exterior equipment	65
Safety and security	66
Steering wheels	67
Audi Complete and warranty	68
Merchandise	69
Accessories	70

## Technical details

Technical data	71
Dimensions	72
Additional information	73
Pricing information	75





## Vorsprung durch Technik

Three words that express the very essence of Audi. Vorsprung durch Technik isn't a slogan. It's our way of seeing the world. It is the driving force behind our history of innovation that continues into the 21st century. Indeed, many technologies that Audi pioneered remain in our cars today. Some are milestones in

the history of the motorcar. From our beginnings in 1899, to the Auto Union team's Grand Prix successes in the 1930s and our more recent wins at Le Mans, we have always been at the forefront of the motor industry.

Vorsprung durch Technik makes us who we are. To see more of its influence, just read on.











## **The Audi Q7 is available with our latest clean diesel technology**

The Audi Q7 is available with a choice of powerful engines, all of which use advanced fuel-injection technology. Features include adaptive air suspension, rear acoustic parking, rear LED lights and an optional HDD-based navigation system, as well as one other trademark Audi innovation: road-holding quattro® permanent all-wheel-drive, which keeps the car balanced in all conditions, across any terrain. Select the 3.0 TDI® 'clean diesel' version and you can take advantage of one of the cleanest diesel technologies in the world, which uses a special additive to significantly reduce nitrogen oxide emissions. Whichever model you choose, you'll also benefit from the practical 7-seat interior, which leaves enough room for the whole family.





## **Q7 interior story**

We've introduced a number of finishing touches to the Audi Q7 interior to make your driving experience both comfortable and unique. You'll find an impressive attention to detail in everything from the luxurious leather seating to our optional customised stitching, which means that every journey you make will be a personal one.

# Engines

## Petrol

TFSI® direct-injection technology is a unique Audi innovation that includes supercharging, which combines FSI® technology with forced induction – giving cars an extra injection of power and torque. It also delivers enhanced fuel efficiency as precisely the right amount of fuel and air are injected into the combustion chambers, enabling the engine to ‘breathe’ more easily. It results in reduced heat loss and increased output, with around a 15% reduction in fuel consumption and significantly lower exhaust emissions.

## Diesel

We introduced TDI® to the roads in 1989, marking a departure from the noisy, fuel-thirsty diesel engines of the past. And since then, we’ve continuously refined it, recently developing common-rail technology. Under this system, a series of piezo injectors use electrical charge to precisely control the amount of fuel injected into the engine. As well as reducing noise, this allows combustion to happen at a lower temperature, with less oxygen, which lowers emissions.





## Transmission

### 8-speed tiptronic

The Audi Q7 comes with an advanced 8-speed tiptronic transmission system which reduces both fuel consumption and CO<sub>2</sub> emissions. It converts high-torque engine power into sporty performance and operating convenience, with crisp, fast gear changes and an optimised gear-shift strategy. More spontaneous gear changes are a particular benefit, especially when downshifting. Both in the 'D' (Drive) and 'S' (Sport) programme, the advanced electronics used in tiptronic respond efficiently to every driver input.

## Efficiency

At Audi, doing less is something we're trying to do more of. We're working to use less fuel, release less CO<sub>2</sub> and waste less energy. It's why we've incorporated a number of more efficient technologies into the Audi Q7.

## Recuperation

When a vehicle brakes, the discs convert the kinetic energy into thermal energy, which is wasted as it cannot be used. With a recuperation system like the one in the Audi Q7, the kinetic energy is converted into useful electrical energy. The way it works is simple. While the car is coasting or braking, the alternator voltage is raised above the level of the basic electrical system, which enables the alternator to generate electrical energy and store it temporarily in the battery. When the vehicle accelerates, this energy is used to relieve the load on the alternator, resulting in a fuel saving of up to 3%.





### **Aerodynamics**

A car's shape can have a big impact on its efficiency. It's why we've worked to make the Audi Q7 as aerodynamic as possible, including technology such as adaptive air suspension that responds to changes in speed. It means that the Audi Q7 becomes more aerodynamic at high speeds, while still offering good ground clearance in off-road situations.

### **Automatic Start-Stop function\***

In heavy traffic, your car still uses fuel and releases CO<sub>2</sub>, even when it's stationary. The automatic Start-Stop function counteracts this problem by switching off the engine when your car comes to a standstill. As soon as you release the brake pedal, the car restarts.

\*Only available on 3.0 TDI engines.

## quattro®

It's the technology that gave us the edge on the rally circuit from the moment it was first introduced over 30 years ago, bringing victory for the Audi quattro on its very first outing. It's called quattro® permanent all-wheel-drive. In this system, four permanently driven wheels deliver better acceleration, road-holding and safety, while asymmetric-dynamic torque distribution intelligently controls the flow of power to the front and rear axles.

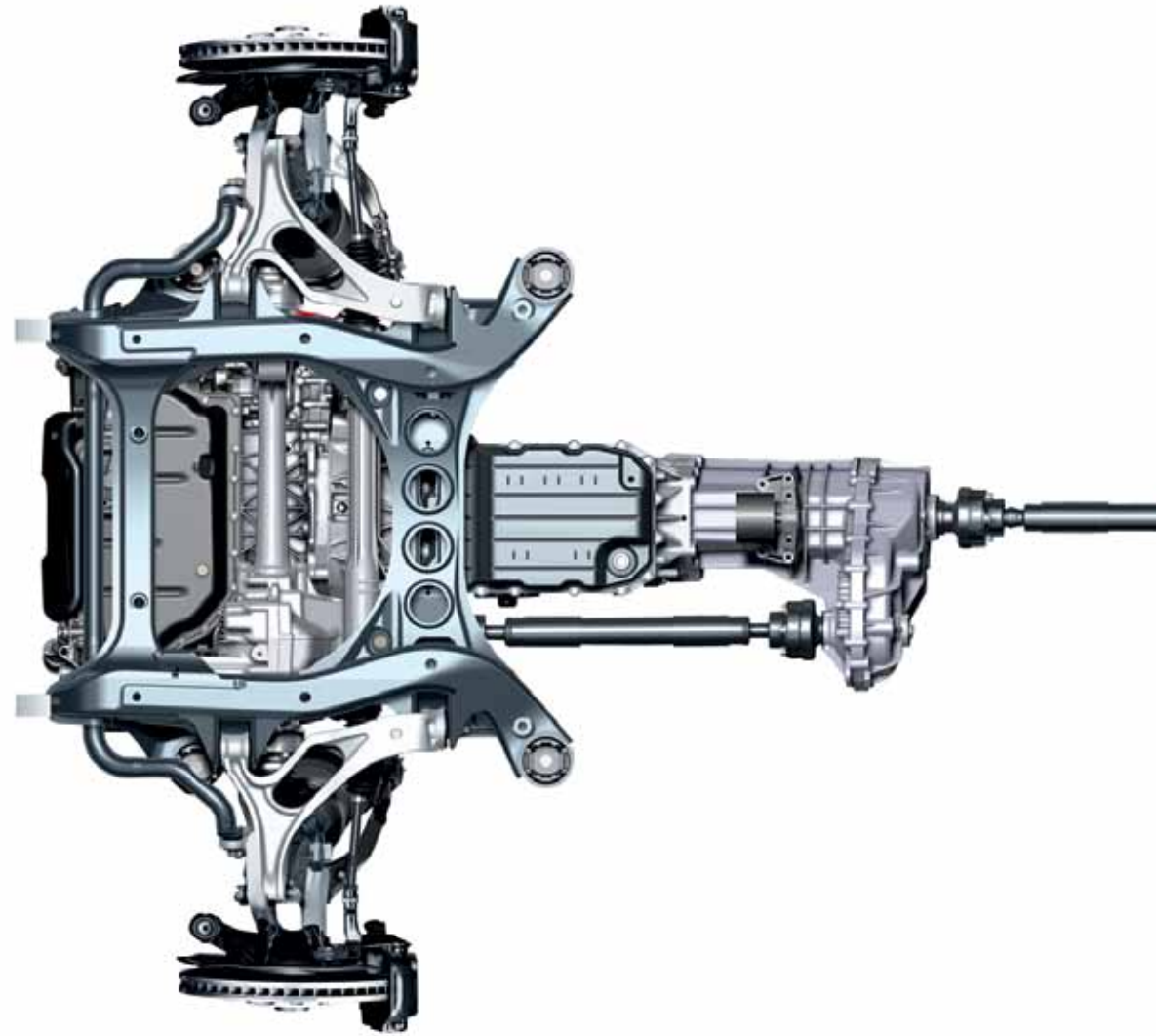



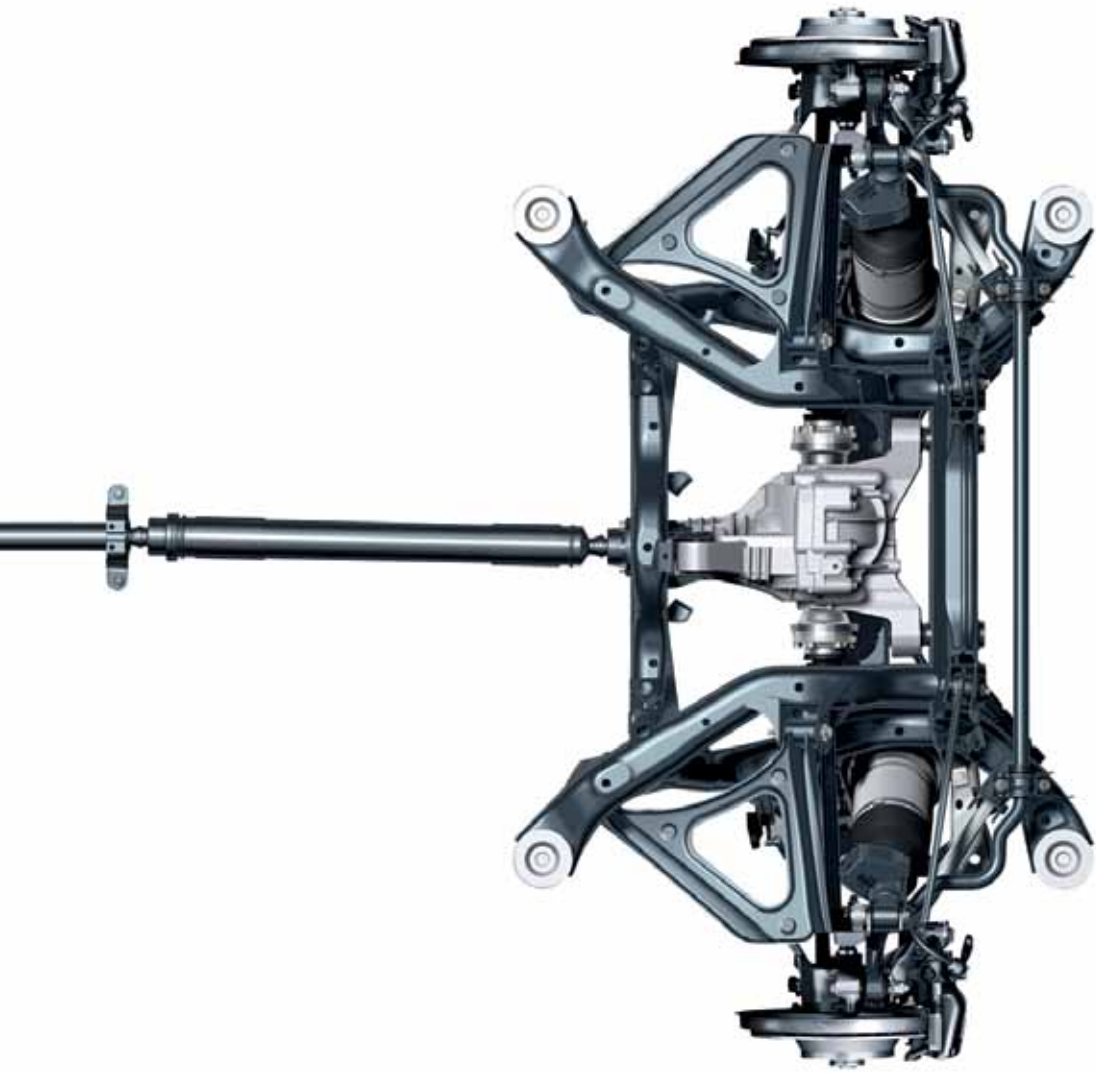

It means that the Audi Q7 can 'read' the road, sensing changes in the surface beneath the wheels and adjusting their grip accordingly. So when conditions get a little more demanding – in particular, when you go off-road – quattro® adapts, putting all the force of the Audi Q7's engine precisely where it's needed to handle the change in terrain.





# Standard model equipment

All Audi Q7 models have the following items of standard equipment

## Engine and transmission

Automatic Start-Stop function for greater fuel and CO<sub>2</sub> efficiency (3.0 TDI engines only)

Recuperation for optimal energy utilisation

Energy saving tips feature in Driver's Information System

8-speed automatic tiptronic transmission with Dynamic Shift Program (DSP)

## Wheels, tyres and suspension

18" x 8J '6-arm' design alloy wheels with 225/55 R18 Y tyres

Adaptive air suspension – electronically controlled air suspension with continuously adaptive damping system for all four wheels which regulates ride height and damping automatically. Choice of 5 modes (automatic, comfort, dynamic, off-road and lift) selected via the MMI system

## Locking wheel-bolts

quattro permanent all-wheel-drive with asymmetric-dynamic torque distribution

Parking brake – foot-operated

Tool kit and car jack

Collapsible spare wheel (with compressor) – max. speed 50mph

## Audio and communication

MMI Radio

CD player in front instrument panel

## Seats

7 seats (3 rows of seats) – second and third row can be split and folded flat to form a level load-area

Cosmo cloth upholstery

## Safety and security

Anti-theft alarm (Thatcham Category 1 approved)

Anti-lock Braking System (ABS) and Electronic Brake-force Distribution (EBD)

Door exit lights at the front

Door lock switches on all 4 doors

Electronic Differential Lock (EDL)

Electronic Stability Programme (ESP) with extended on- and off-road functions and Trailer Stabilisation system

First-aid kit

ISOFIX – front passenger, second and third row seats with front passenger airbag de-activation switch

Rear acoustic parking

Service key which automatically memorises individual vehicle settings and service information

Side airbags for driver and front passenger

Side-impact protection in the doors

Sideguard head airbag system to protect front and outer rear passengers in a side collision

Warning triangle



18" x 8J '6-arm' design alloy wheels



Chrome grille



Rear LED lights



Dual-zone electronic climate control

### Interior equipment

**4-spoke multi-function leather steering wheel**

**12V sockets** – 1 at front of centre console, 2 at rear of centre console and 1 in luggage compartment

**Auto-dimming rear-view mirror**

**Cargo nets on backs of front seats**

**Compartment for glasses in roof module**

**Cruise control**

**Cup holders** – 2 at front of centre console, 2 in rear armrest and 2 in side trim of third seating row

**Double load-floor** with storage compartment and dirt-resistant tray

**Driver's Information System (DIS)** with efficiency programme

**Dual-zone electronic climate control**

**Floor mats**, front and rear

**Front centre armrest**, folding with storage compartment

**Illuminated vanity mirrors**

**Inlays in Gloss black**

**Luggage compartment cover**

**Luggage net in luggage compartment**

**Rear centre armrest** in rear-seat backrest, folding, with 2 cup holders

**Scuff plates** with metal inlays

**Servotronic steering** – power-steering with speed-dependent control

**Storage net** at side of luggage compartment

**Through-load hatch** in the rear-seat backrest

### Exterior equipment

**Contrasting bumpers** – front and rear bumpers and side sills painted (bumper colour is dependent on paint colour – see page 45 for more information)

**Door mirrors** – electrically-operated, heated and folding

**Front fog lights**

**Halogen headlights**

**Light and rain sensor** for automatic activation of headlights and front wipers

**Roof rails (black)**

**Rear LED lights**



Split-folding rear seats



3rd row of seats



Adaptive air suspension



quattro permanent all-wheel-drive

# SE model equipment

In addition to Standard model equipment

**Basic RRP**  
£2,470.83

**Total RRP inc VAT**  
£2,965.00

## Wheels, tyres and suspension

19" '5-arm V' design alloy wheels with 265/50 R19 110Y tyres

## Seats

**Cricket leather upholstery** to centre of seat, head restraints and front and rear centre armrests. Door panel in Alcantara

**Front seats**, electrically adjustable with adjustment for forwards/backwards position, seat height, seat and backrest angle, and electric lumbar support

**Seat heating for front seats**

## Audio and communication

**Mobile telephone preparation – Bluetooth interface.** Provides handsfree connection via Bluetooth using mobile phone aerial. Please contact your Audi Centre for phone compatibility

## MMI Radio Plus:

- 6.5" colour screen
- Single CD player
- FM/AM radio
- DSP sound system
- 2x SD memory card readers

## Interior equipment

**Aluminium-look air vent surrounds**

**Comfort front centre armrest**

**Inlays in Aluminium Marlin silver**

**Lighting package** – includes door lighting under the exterior door mirrors, ambient LED lighting of the centre console, active door reflectors in the front and rear doors, footwell LED lighting at front and rear, rear door exit lights, lighting for air vents in the B pillar and ashtray in the rear

## Exterior equipment

**Aluminium window trim** framing the exterior side windows and aluminium roof rails



19" '5-arm V' design alloy wheels



Cricket leather upholstery



Aluminium window trim



Comfort front centre armrest



# S line model equipment

In addition to SE model equipment

**Basic RRP**  
£1,383.33

**Total RRP inc VAT**  
£1,660.00

## Wheels, tyres and suspension

20" x 9J '5-spoke' design alloy wheels with 275/45 R20 Y tyres

## Seats

Front Sports seats, electrically adjustable with adjustment for forwards/backwards position, seat height, seat and backrest angle and electric lumbar support

Pearl Nappa leather/Alcantara upholstery

## Interior equipment

3-spoke multi-function leather steering wheel with gear-shift paddles

Black headlining

Inlays in matt-brushed aluminium

S line scuff plates

## Exterior equipment

Headlight washers

S line badge on side wings (except on 3.0 TFSI engines where there is a V6T badge)

S line body styling, fully body coloured

Xenon Plus headlights with LED daytime-running lights and LED indicators



20" x 9J '5-spoke' design alloy wheels



Xenon Plus headlights with LED daytime-running lights



Front Sports seats in Pearl Nappa leather/Alcantara



3-spoke multi-function leather steering wheel





# S line Plus model equipment

## In addition to S line model equipment

**Basic RRP**  
£3,750.00

**Total RRP inc VAT**  
£4,500.00\*

### Wheels, tyres and suspension

21" x 10J '5-segment-spoke' design alloy wheels with 295/35 R21 tyres

### Seats

Verano Leather Upholstery

### Exterior equipment

**Privacy glass** Dark tinted glass from B-pillar backwards

### Running boards

**Metallic or pearl effect paint** – a choice of 13 colours

**Power-operated tailgate** – opens by pressing button on the car key, button in the driver's door trim or soft-touch button in the handle recess on the luggage compartment lid. Including lid-closing assistance unit and programmable angle for the luggage compartment lid

### Audio and communication

**Satellite Navigation system – HDD-based including MMI Radio Plus** – route planning and guidance using voice, pictogram and 3D mapping. Includes AM/FM tuner with TP memo function. Single front-loading CD/DVD player with MP3 compatibility, suitable for audio and DVD playback. Third generation MMI system including high resolution (800x400) 7" colour TFT display, two SD card readers and 40GB hard drive, 10GB of which can be used to store up to 4,000 songs. HDD navigation functionality includes advanced speech recognition, 7-digit postcode functionality, 3D and topographical mapping display and advanced 3D building display

**Mobile telephone preparation – High with Audi connect.** Allows a Bluetooth-capable mobile phone to connect to the vehicle's internal UMTS module (providing the mobile phone has a SIM Access Profile\*\*). This allows the navigation to use Google Earth images and Audi traffic information online. Please see page 60 for more details

**Colour Driver's Information System (DIS)** with efficiency programme

**Audi parking system advanced** – aids parking by acoustically and visually indicating distances to obstacles with guiding lines measured by sensors and reversing camera

**Audi Music Interface** – universal connection for use with stereo audio sources, USB and MP3 devices including Apple iPod generation 4 onwards (iPod, iPod classic, iPod mini, iPod nano, iPod photo, iPod video, iPod touch). Provides intuitive control through the audio system and multi-function steering wheel. It also replicates the iPod display on the audio screen and DIS, including track titles. The interface provides charging function (dependent on device). Includes 2 cables to connect your iPod or USB MP3 player

When ordered with a sunroof (3FU/3FV) and electric trailer towing hitch (1D9), deletion of third seating row (5KM) must be added.

\*\*Online services are only available for mobile phone contracts including a data option and only within the coverage of the mobile phone network; there may be additional costs for the use of these services (charges and billing correspond to the personal mobile phone contract). Due to high data volumes, a mobile phone contract including an unlimited data plan is strongly recommended. The content and scope of online-based services offered may vary.



21" x 10J '5-segment spoke' design alloy wheels



Running boards



Privacy glass



Satellite Navigation system – HDD-based



## Audi Q7 Standard

Engines	Power	Transmissions	CO <sub>2</sub> g/km	Basic RRP	Total RRP inc VAT	Recommended OTR
3.0 TFSI quattro	272PS	8-speed tiptronic	249	£34,295.83	£41,155.00	£42,615.00
3.0 TDI quattro	204PS	8-speed tiptronic	189	£32,420.83	£38,905.00	£40,010.00
3.0 TDI quattro	245PS	8-speed tiptronic	195	£33,612.50	£40,335.00	£41,440.00
3.0 TDI quattro clean diesel	245PS	8-speed tiptronic	195	£34,558.33	£41,470.00	£42,575.00

## Audi Q7 SE

Engines	Power	Transmissions	CO <sub>2</sub> g/km	Basic RRP	Total RRP inc VAT	Recommended OTR
3.0 TFSI quattro	272PS	8-speed tiptronic	249	£36,766.67	£44,120.00	£45,580.00
3.0 TFSI quattro	333PS	8-speed tiptronic	249	£40,170.83	£48,205.00	£49,665.00
3.0 TDI quattro	204PS	8-speed tiptronic	189	£34,891.67	£41,870.00	£42,975.00
3.0 TDI quattro	245PS	8-speed tiptronic	195	£36,083.33	£43,300.00	£44,405.00
3.0 TDI quattro clean diesel	245PS	8-speed tiptronic	195	£37,029.17	£44,435.00	£45,540.00
4.2 TDI quattro	340PS	8-speed tiptronic	242	£43,800.00	£52,560.00	£54,020.00

**Please note:** The maximum power output figures are quoted in PS (or Pferdestärke, which is the metric equivalent of brake horsepower). To convert to brake horsepower, divide the PS figure by 1.0139.

**Recommended On-The-Road (OTR) retail prices include:** delivery charge, half a tank of fuel, number plates at £590.00 (inc. VAT), Road Fund Licence (which may vary depending on model/transmission – see page 73 for details) and first registration fee at £55.00. Vehicle Excise Duty correct at time of going to print, but this may alter to reflect any change in the applicable VED rate.

RRP – Recommended Retail Price. VAT is calculated at 20% but this may alter to reflect any change in the applicable VAT rate.

## Audi Q7 S line

Engines	Power	Transmissions	CO <sub>2</sub> g/km	Basic RRP	Total RRP inc VAT	Recommended OTR
3.0 TFSI quattro	272PS	8-speed tiptronic	249	£38,150.00	£45,780.00	£47,240.00
3.0 TFSI quattro	333PS	8-speed tiptronic	249	£41,554.17	£49,865.00	£51,325.00
3.0 TDI quattro	204PS	8-speed tiptronic	189	£36,275.00	£43,530.00	£44,635.00
3.0 TDI quattro	245PS	8-speed tiptronic	195	£37,466.67	£44,960.00	£46,065.00
3.0 TDI quattro clean diesel	245PS	8-speed tiptronic	195	£38,412.50	£46,095.00	£47,200.00
4.2 TDI quattro	340PS	8-speed tiptronic	242	£45,183.33	£54,220.00	£55,680.00

## Audi Q7 S line Plus

Engines	Power	Transmissions	CO <sub>2</sub> g/km	Basic RRP	Total RRP inc VAT	Recommended OTR
3.0 TFSI quattro	272PS	8-speed tiptronic	249	£41,900.00	£50,280.00	£51,740.00
3.0 TFSI quattro	333PS	8-speed tiptronic	249	£45,304.17	£54,365.00	£55,825.00
3.0 TDI quattro	204PS	8-speed tiptronic	189	£40,025.00	£48,030.00	£49,135.00
3.0 TDI quattro	245PS	8-speed tiptronic	195	£41,216.67	£49,460.00	£50,565.00
3.0 TDI quattro clean diesel	245PS	8-speed tiptronic	195	£42,162.50	£50,595.00	£51,700.00
4.2 TDI quattro	340PS	8-speed tiptronic	242	£48,933.33	£58,720.00	£60,180.00





## Audi exclusive

Every Audi is intrinsically exclusive. It's the breathtaking design, the exceptional engineering, the Vorsprung durch Technik. But for that special touch you can specify your Audi Q7 with options from Audi exclusive. Whether you want a unique, custom-mixed paint colour or seats in a combination of complementary shades, Audi exclusive will enable you to drive the car you've always imagined.

Both the exclusive and standard options can be found on the following pages.







## Audi exclusive line

There are a number of ways to customise your car's interior with the Audi exclusive range. And if you'd like us to help you choose, we've put the most popular elements of the range together into one harmonious package – the Audi exclusive line.

With experience over more than 20 years, our expert designers understand which elements work well together. From high-quality Fine Nappa leather seats to Audi exclusive door sill trims, every detail has been chosen to truly enhance your drive.

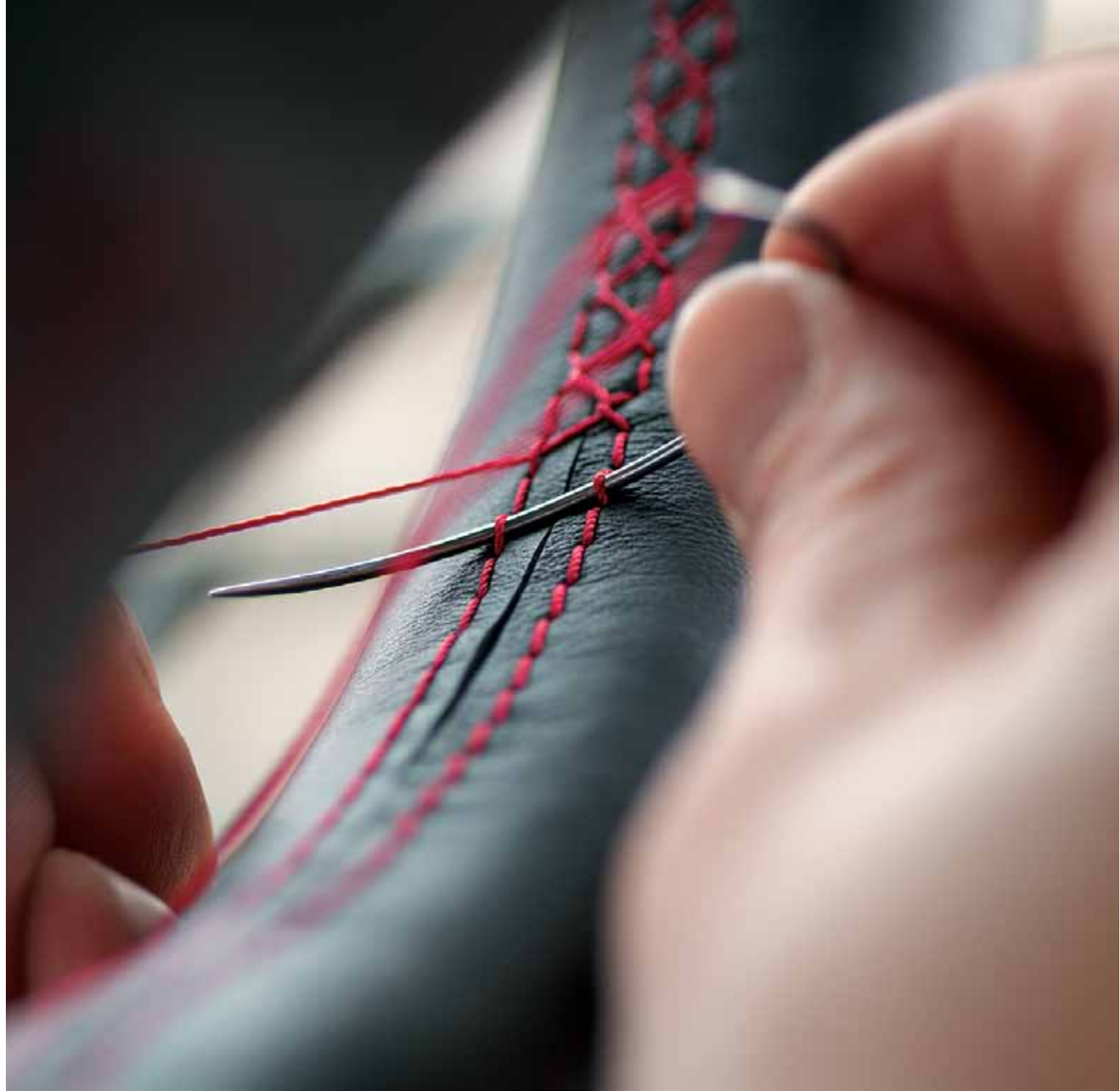

## Paint choices

We believe that every part of your car should have a personal touch. Which is why you can choose from a wide range of paint colours and finishes, from standard shades to metallic and pearl effects. We can even mix a customised colour for you to create the perfect fit.

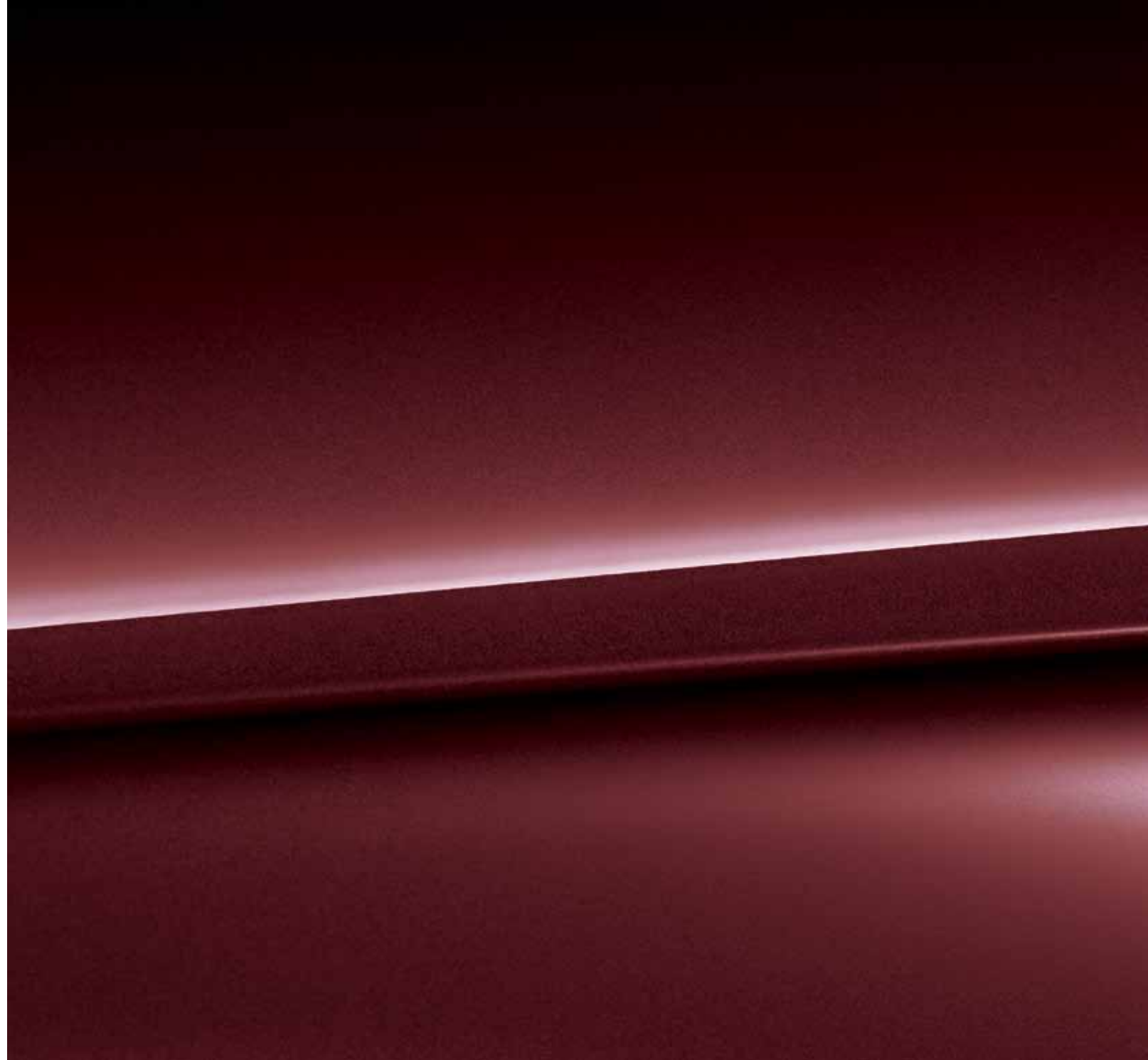

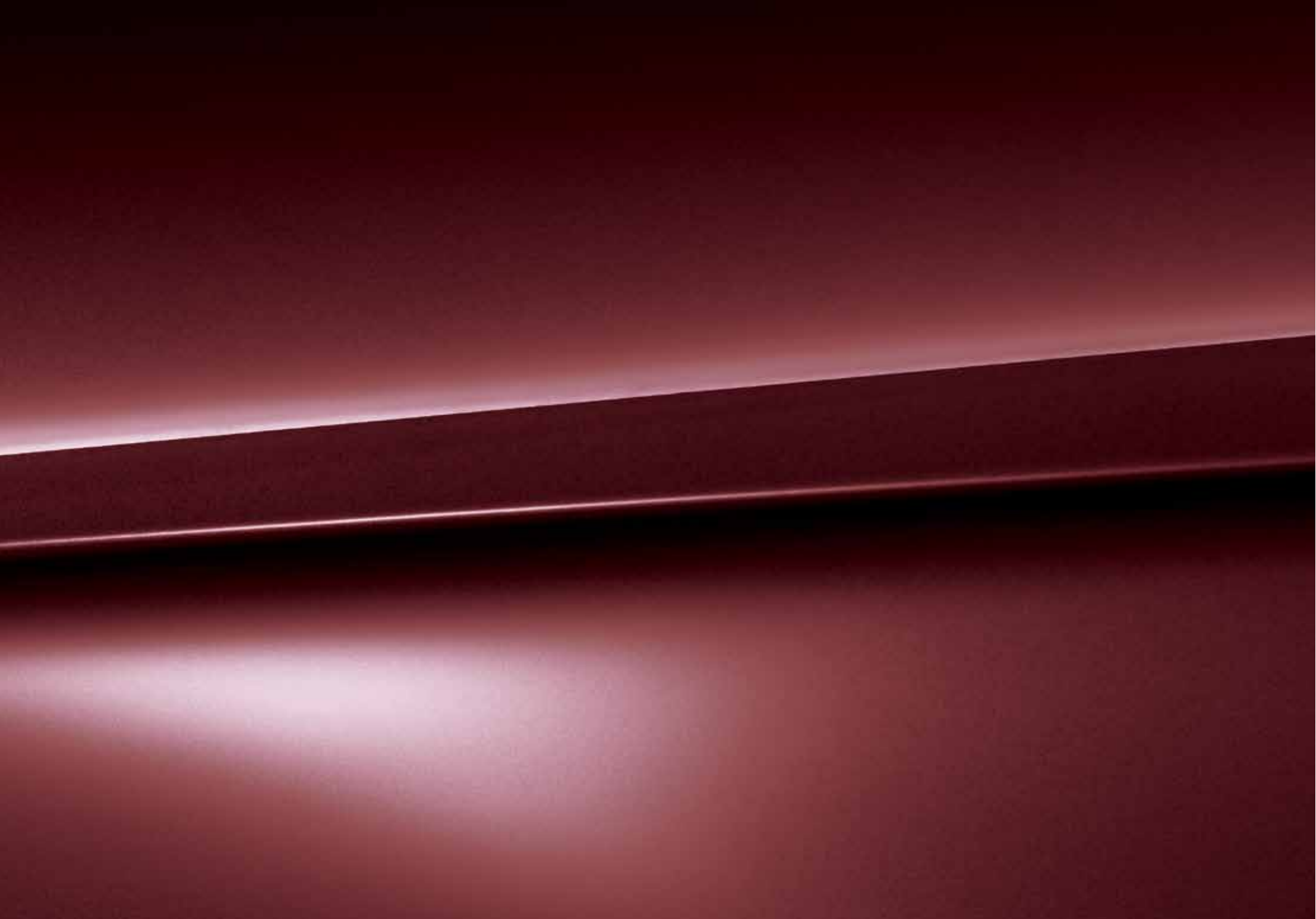

# Paint

You can select one of the standard colours shown opposite or, for a different look, choose from a range of optional finishes.

## Standard colours



Pure white - **0Q**

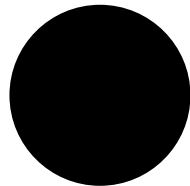

Night black - **A1**

## Optional colours

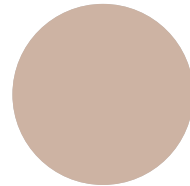

Bahia beige, metallic - **6L**

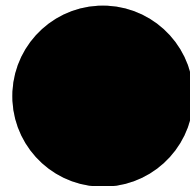

Orca black, metallic - **2T**

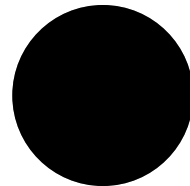

Lava grey, pearl effect - **1R**

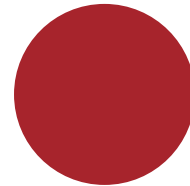

Garnet red, pearl effect - **9C**

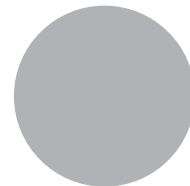

Ice silver, metallic - **P5**

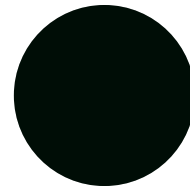

Graphite grey, metallic - **9Q**



Glacier white, metallic - **2Y**

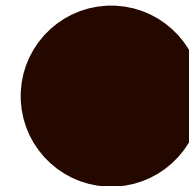

Teak brown, metallic - **4U**

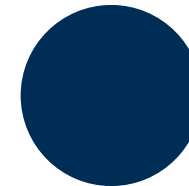

Atlantis blue, metallic - **Z2**

## S line colours

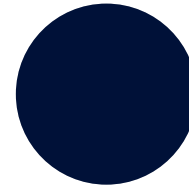

Mugello blue, pearl effect - **5W**

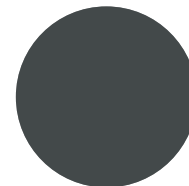

Daytona grey, pearl effect - **6Y**

Options are subject to availability and may extend delivery.

All the colour swatches on this page are matched as accurately as possible to the actual paint colours used. However, due to print processes, Audi UK cannot guarantee that colours shown are 100% accurate.

Visit your local Audi Centre for a more accurate colour swatch.

RRP - Recommended Retail Price.

VAT is calculated at 20% but this may alter to reflect any change in the applicable VAT rate.

### Optional and S line colours

**Basic RRP**

£637.50

**Total RRP inc VAT**

£765.00

No charge on S line Plus models

# Paint

## Audi exclusive

Everyone has a favourite colour. No matter what yours is, Audi exclusive provides a range of unique colours that have been designed to set your car apart. Choose from the swatches here, or specify any other paint colour in the Audi range – whether it's Jet blue from the Audi R8 or Alpine white from the original Audi quattro. The choice is yours.

## Customised

If you have a particular colour in mind, we'll mix the exact metallic or pearl-effect shade you want.\*

\*Custom paint is subject to factory approval, and is available for metallic and pearl-effect water-based paints only. Three-colour process colours and two-tone schemes are not available.

\*\*Visit your local Audi Centre for colour samples.

All the colour swatches on this page are matched as accurately as possible to the actual paint colours used. However, due to print processes, Audi UK cannot guarantee that colours shown are 100% accurate.

Visit your local Audi Centre for a more accurate colour swatch.

RRP – Recommended Retail Price.

VAT is calculated at 20% but this may alter to reflect any change in the applicable VAT rate.

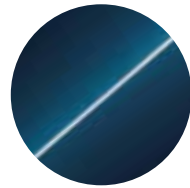

Palace blue, pearl effect

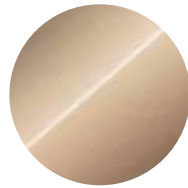

Sand beige, pearl effect

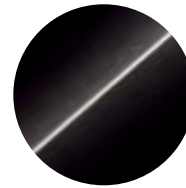

Saddle brown, pearl effect

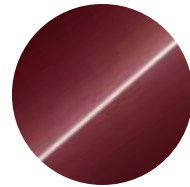

Classic red, pearl effect

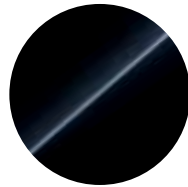

Mamba black, metallic

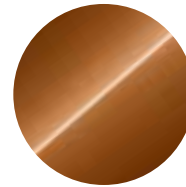

Ipanema brown, metallic



Any colour in the Audi range



100 Audi exclusive colours to choose from\*\*

<b>Audi exclusive</b>
<b>Basic RRP</b>
£1,445.83
<b>Total RRP inc VAT</b>
£1,735.00



Customised paint

<b>Customised*</b>
<b>Basic RRP</b>
£2,041.66
<b>Total RRP inc VAT</b>
£2,450.00

## Upholstery

It's important to feel comfortable on the road. Just choose from our range of luxury upholstery materials and textures, including additional support and colour options, for complete relaxation while you drive.





# Upholstery

## Standard seats

Choose your favourite upholstery from the swatches shown opposite to give your car's interior the look and feel you want.







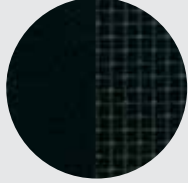
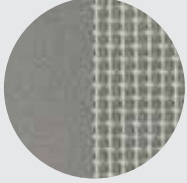
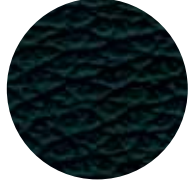

Options are subject to availability and may extend delivery.

-- = Not available  
 ● = Available  
 S = Standard

Leather upholstery is only available on Standard trim models in combination with a free of charge upgrade to inlays. Please see page 52 for the selection.

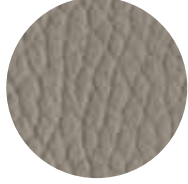
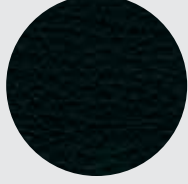
RRP - Recommended Retail Price.

VAT is calculated at 20% but this may alter to reflect any change in the applicable VAT rate.

										Standard	SE	S line	S line Plus	Basic RRP	Total RRP inc VAT
Cosmo cloth - N2T										S	-	-	-	No charge	No charge
	Black - CA	Light grey - CF													
Cricket leather - PEB										●	S	-	-	£1,616.67	£1,940.00
	Black - CA/FP	Light grey - CF/CG	Paranut brown - FR/FQ	Savanna beige - FT/FS											
		Cardamom beige - FV/FU													
Verano leather - PEC										●	-	-	-	£2,295.83	£2,755.00
	Black - CA/FP	Light grey - CF/CG	Paranut brown - FR/FQ	Savanna beige - FT/FS						-	●	-	-	£679.17	£815.00
		Cardamom beige - FV/FU													



# Upholstery

## Sports seats

Front seats are electrically adjustable.

Pearl Nappa  
leather/Alcantara  
- PED



Black - CA/FP



Light grey - CF/CG

Verano leather  
- PEE



Black - CA/FP

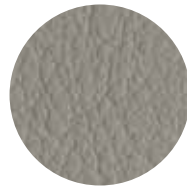

Light grey - CF/CG

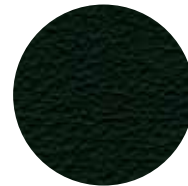

Paranut brown - FR/FQ

	Standard	SE	S line	S line Plus	Basic RRP	Total RRP inc VAT
●	-	-	-	-	£2,170.83	£2,605.00
-	●	-	-	-	£554.17	£665.00
●	-	-	-	-	£3,320.83	£3,985.00
-	●	-	-	-	£1,704.17	£2,045.00



Options are subject to availability and may extend delivery.

- = Not available
- = Available
- S = Standard

Leather and Leather/Alcantara upholstery is only available on Standard trim models in combination with electric front seats (PV1/PV6) and a free of charge upgrade to inlays. Please see page 52 for the selection.

RRP - Recommended Retail Price.

VAT is calculated at 20% but this may alter to reflect any change in the applicable VAT rate.

# Upholstery

## S line Sports seats

Sports seats including electrically adjustable lumbar support.

Leather/Alcantara  
– N7K



Black – QE



Black with silver stitching – QF

Verano leather  
– N1W

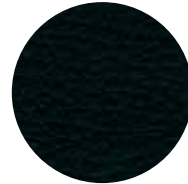

Black – QE

	Standard	SE	S line	S line Plus	Basic RRP	Total RRP inc VAT
Leather/Alcantara – N7K	–	–	S	–	No charge	No charge
Verano leather – N1W	–	–	•	–	£1,150.00	£1,380.00
	–	–	–	S	No charge	No charge

Options are subject to availability and may extend delivery.

- = Not available
- = Available
- S = Standard

RRP – Recommended Retail Price.

VAT is calculated at 20% but this may alter to reflect any change in the applicable VAT rate.



# Colour and trim guide

## Interior trim colours

### Standard seats

To help you choose the right interior for your Audi Q7, please use this guide, showing the carpet, dashboard and headlining colours that have been matched to your chosen upholstery.

Order Code	Upholstery	Carpet	Dashboard (upper/lower)	Headlining	Cosmo cloth (N2T)	Cricket leather (PEB)	Verano leather (PEC)
CA	Black	Black Velour	Black/Black	Light grey	●	●	●
CF	Light grey	Grey Velour	Black/Grey	Light grey	●	●	●
FR	Paranut brown	Black Velour	Black/Black	Light grey	—	●	●
FT	Savanna beige	Black Velour	Black/Black	Linen beige	—	●	●
FV	Cardamom beige	Tara beige Velour	Pimento beige/Tara beige	Linen beige	—	●	●
FP	Black	Black/Multicolour Fresco	Black/Black	Light grey	—	●	●
CG	Light grey	Grey-beige/Multicolour Fresco	Black/Grey	Light grey	—	●	●
FQ	Paranut brown	Black/Multicolour Fresco	Black/Black	Light grey	—	●	●
FS	Savanna beige	Black/Multicolour Fresco	Black/Black	Linen beige	—	●	●
FU	Cardamom beige	Grey-beige/Multicolour Fresco	Pimento beige/Tara beige	Linen beige	—	●	●

### Sports seats

Order Code	Upholstery	Carpet	Dashboard (upper/lower)	Headlining	Verano leather (PEE)	Pearl Nappa leather/Alcantara (PED)
CA	Black	Black Velour	Black/Black	Light grey	●	●
CF	Light grey	Grey Velour	Black/Grey	Light grey	●	●
FR	Paranut brown	Black Velour	Black/Black	Light grey	●	●
FP	Black	Black Velour	Black/Black	Light grey	●	●
CG	Light grey	Grey-beige/Multicolour Fresco	Black/Grey	Light grey	●	●
FQ	Paranut brown	Black/Multicolour Fresco	Black/Black	Light grey	●	—

### S line Sports seats

Order Code	Upholstery	Carpet	Dashboard (upper/lower)	Headlining	Verano leather (N1W)	Pearl Nappa leather/Alcantara (N7K)
QE	Black	Black	Black/Black	Black	●	●
QF	Black with silver stitching	Black	Black/Black	Black	—	●

Options are subject to availability and may extend delivery.

- = Not available
- = Available
- S = Standard

# Colour and trim guide

## Exterior colour and bumper guide

(Standard and SE models only)

### Solid paint

Order Code	Exterior colour	Soul black	Platinum grey
<b>0Q</b>	Pure white	●	—
<b>A1</b>	Night black	—	●

### Metallic paint

Order Code	Exterior colour	Soul black	Platinum grey
<b>P5</b>	Ice silver	●	—
<b>9Q</b>	Graphite grey	●	—
<b>4U</b>	Teak brown	●	—
<b>2T</b>	Orca black	—	●
<b>2Y</b>	Glacier white	—	●
<b>5F</b>	Cobalt blue	—	●
<b>6L</b>	Bahia beige	●	—

### Pearl-effect paint

Order Code	Exterior colour	Soul black	Platinum grey
<b>1R</b>	Lava grey	—	●
<b>9C</b>	Garnet red	—	●

Options are subject to availability and may extend delivery.

- = Not available
- = Available
- S = Standard

# Upholstery

## Audi exclusive

With Audi exclusive, you can specify your seats in Fine Nappa leather or Fine Nappa/Alcantara, in an array of different colours shown here.

Select just one all-over shade for each seat, or customise each panel in two or more complementary colours from the distinctive Audi exclusive palette. You can even choose the colour of the decorative stitching – to match or contrast with your chosen upholstery – from this varied collection. Whatever combination you decide upon, we think you'll be extremely comfortable with the result.



Chestnut brown



Jet grey



Alabaster white

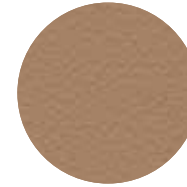

Sand beige

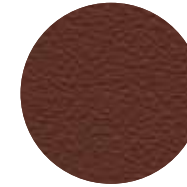

Saddle brown

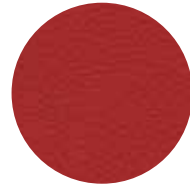

Crimson red



Magnolia white



Havanna brown

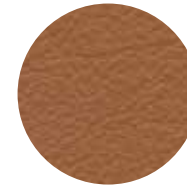

Cognac brown

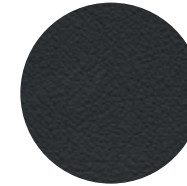

Night blue

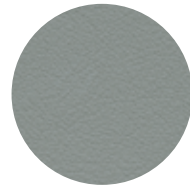

Cloudy grey

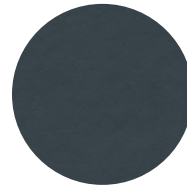

Smoky blue

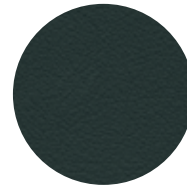

Iceland green



Powder beige



Classic red

### Also available:

**Alcantara colours:** available in all the Audi exclusive colours shown, except for Crimson red, Jet grey and Sand beige. Alcantara equivalents are Chilli red, Amethyst grey, and Sesame beige respectively.

Please consult your Audi Centre for examples of Alcantara and carpet colours.

# Upholstery

## Audi exclusive

Order Code		Standard	SE	S line	S line Plus	Basic RRP	Total RRP inc VAT
<b>PYA S3G</b>	<b>Audi exclusive leather package 1 in Fine Nappa leather*</b> . Includes leather-covered seat upholstery and front centre armrest, velour carpets and floor mats and aluminium air vent surrounds. Backrest covers and seat add-on parts come in the interior trim colour. Only available in combination with CA/CF interior trim and seat heating (4A3/4A4)	–	●	–	–	£2,783.33	£3,340.00
<b>PYG S3G</b>	<b>Audi exclusive leather package 1 in Fine Nappa leather with Sports seats*</b> . Includes all the contents of leather package 1 plus: leather-covered front Sports seats. Seat side trims and add-on parts come in the interior trim colour. On S line and S line Plus, only available in combination with Carbon inlay (STU)	–	●	–	–	£3,808.33	£4,570.00
<b>PYC S3G</b>	<b>Audi exclusive leather package 1 in Fine Nappa leather/Alcantara with Sports seats*</b> . Includes leather-covered seat-side trims, head restraints and front centre armrest, Alcantara door trim inserts and seat-centre sections, chrome air vent surrounds and velour carpets and floor mats. Backrest covers and seat add-on parts come in the interior trim colour. Only available in combination with CA/CF interior trim. On S line and S line Plus, only available in combination with Carbon inlay (STU)	–	●	–	–	£3,320.83	£3,985.00
<b>PYD S3G</b>	<b>Audi exclusive leather package 2 in Fine Nappa leather*</b> . Includes all the contents of leather package 1 (PYA/S3G) plus: leather-covered seat backrest covers, door armrests and handles. Seat-side trims and add-on parts are colour coordinated. Only available in combination with CA/CF interior trim	–	●	–	–	£4,679.17	£5,615.00
<b>PYJ S3G</b>	<b>Audi exclusive leather package 2 in Fine Nappa leather with Sports seats*</b> . Includes all the contents of leather package 2 plus: leather-covered front Sports seats. Seat side trims and add-on parts colour coordinated. On S line and S line Plus, only available in combination with Carbon inlay (STU)	–	●	–	–	£5,704.17	£6,845.00
<b>YRI S3G</b>	<b>Audi exclusive steering wheel in wood and leather*</b> . Wood and leather can be chosen from the Audi exclusive inlays and leather colours. Only in combination with matching Audi exclusive inlays. Not available in combination with 4-spoke multi-function steering wheel – heated, with gear shift paddles (2ZD)	–	●	–	–	£554.17	£665.00
<b>YRB S3G</b>	<b>Audi exclusive controls package*</b> . Includes leather-covered steering wheel and gear-shift gaiter	●	●	●	●	£466.67	£560.00
<b>YSR S3G</b>	<b>Audi exclusive floor mats with leather piping**</b> . Includes 4 floor mats for front and rear (cannot be combined with option YSQ/S3G – Audi exclusive carpets)	●	●	●	●	£295.83	£355.00
<b>YSQ S3G</b>	<b>Audi exclusive carpets**</b> . Includes 4 Audi exclusive floor mats with leather piping (cannot be combined with option YSR/S3G – Audi exclusive floor mats)	–	●	●	●	£1,191.67	£1,430.00
<b>YUR S3G</b>	<b>Audi exclusive headlining in black Alcantara</b> . Stitching can be specified in a variety of colours from the Audi exclusive range	–	●	–	–	£1,870.83	£2,245.00
<b>YZV S3G</b>	<b>Audi exclusive rear reading lights</b> . With manually adjustable light cone (cannot be ordered in combination with panoramic sunroof 3FU or 3FV)	–	–	●	●	£1,658.33	£1,990.00
<b>YZV S3G</b>	<b>Audi exclusive rear reading lights</b> . With manually adjustable light cone (cannot be ordered in combination with panoramic sunroof 3FU or 3FV)	●	●	●	●	£766.67	£920.00

Options are subject to availability and may extend delivery.

– = Not available  
● = Available  
S = Standard

\*Leather and stitching (where applicable) can be specified in a variety of colours from the Audi exclusive range shown on page 46.

\*\*The floor mats and carpet colour can be selected from any of the Audi exclusive colours shown on page 46.

RRP – Recommended Retail Price.

VAT is calculated at 20% but this may alter to reflect any change in the applicable VAT rate.

# Upholstery

## Audi exclusive line

Audi exclusive is ultimately about choice – but if you'd rather leave some of the decisions in the capable hands of our designers, the expert team at quattro GmbH have compiled Audi exclusive line, combining some of the most popular elements of the exclusive range in one, beautifully coordinated package.

Options are subject to availability and may extend delivery.

- = Not available  
 • = Available  
 S = Standard

RRP – Recommended Retail Price.

VAT is calculated at 20% but this may alter to reflect any change in the applicable VAT rate.

Order Code		Standard	SE	S line	S line Plus	Basic RRP	Total RRP inc VAT
WQ7 YED	Audi exclusive line	I	I	•	•	£2,212.50	£2,655.00



Silver – QL



Cognac brown – QX



Sand beige – QV

### This package includes

- ▶ Two-tone Valcona leather upholstery. Seat centres in Silver (QL), Cognac brown (QX) or Sand beige (QV). Seat-side sections and head restraints in black with decorative stitching to match seat centres
- ▶ Door panels in Valcona leather to match seat centres
- ▶ Black dashboard and carpets
- ▶ Black cloth headlining
- ▶ Audi exclusive door sill trims
- ▶ Matt-brushed aluminium inlays
- ▶ Black front and rear floor mats with leather piping to match seat centres
- ▶ 3-spoke Sports multi-function steering wheel in black leather and gear-lever gaiter with stitching to match seat centres





Image shows optional Audi exclusive line in QL Silver and optional Audi exclusive inlay

## Inlays

Attention to detail can make a big impact. From contemporary black gloss to a natural walnut, our selection of inlays make the perfect finishing touch to your car's interior.





# Inlays

Inlays are the all-important finishing touch that add flair and interest to your car's interior.

Order Code		Standard	SE	S line	S line Plus	Basic RRP	Total RRP inc VAT
5MJ	Gloss finish, black	S	-	-	-	No charge	No charge
5TE	Aluminium trigon*	●	S	-	-	No charge	No charge
5TS	Walnut, natural*	●	●	-	-	No charge	No charge
5MQ	Olive ash, beige*	●	●	-	-	No charge	No charge
5TA	Tamo ash, dark brown*	●	●	-	-	No charge	No charge
5TG	Matt-brushed aluminium	-	-	S	S	No charge	No charge
5TL	Piano finish, black	-	-	●	●	£279.17	£335.00
5TU	Carbon	-	-	●	●	£825.53	£990.00

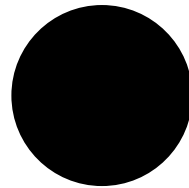

Gloss finish, black – 5MJ

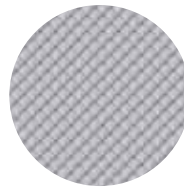

Aluminium trigon – 5TE



Walnut, natural – 5TS



Olive ash, beige – 5MQ

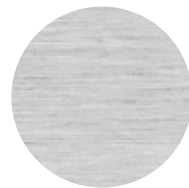

Matt-brushed aluminium – 5TG

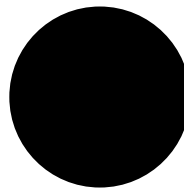

Piano finish, black – 5TL



Carbon – 5TU



Tamo ash, dark brown – 5TA

Options are subject to availability and may extend delivery.

- = Not available  
● = Available  
S = Standard

\*On Standard trim, only available in combination with Leather or Leather/Alcantara upholstery.

RRP – Recommended Retail Price.

VAT is calculated at 20% but this may alter to reflect any change in the applicable VAT rate.

# Inlays

## Audi exclusive

Audi exclusive have sourced a varied range of materials from which to craft these elements – from fine grain ash, nougat to clean, contemporary Piano finish, black.

Order Code

		Standard	SE	S line	S line Plus	Basic RRP	Total RRP inc VAT
<b>YTA S3G</b>	<b>Audi exclusive inlays</b> (cannot be combined with the inlays shown on page 52)	–	•	•	•	£766.67	£920.00
<b>YTD S3G</b>	<b>Audi exclusive gear lever in wood</b> (automatic models, only available in combination with matching Audi exclusive inlays)	–	•	•	•	£170.83	£205.00

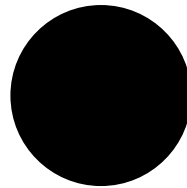

Piano finish, black - 5TL



Fine grain ash, nougat



Fine grain myrtle, nutmeg

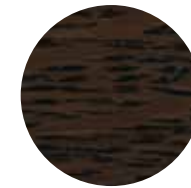

Oak, sepia

Options are subject to availability and may extend delivery.

- = Not available
- = Available
- S = Standard

RRP – Recommended Retail Price.

VAT is calculated at 20% but this may alter to reflect any change in the applicable VAT rate.

## Options

Every driver has different needs, which is why we have created some useful options to further enhance your car. For extra comfort, support, style or function, you can choose from a variety of additional features, tailoring everything from your infotainment and audio equipment to your wheels and lighting.





## Wheels and tyres

Choose a set of specially-selected alloy wheels to subtly enhance the way your car looks and drives.



19" x 8.5J '5-arm V' design alloy wheels - PRL



19" x 8J '5-arm Structure' design alloy wheels - PRD



20" x 9J '10-spoke V' design alloy wheels - PRM



20" x 10J '20-spoke' design two-piece alloy wheels - PQS



20" x 10J '10-spoke' design alloy wheels - PQ5



21" x 10J '5-segment-spoke' design alloy wheels - PQ6



21" x 10J '5-segment-spoke' design alloy wheels in titanium finish - PQ8



21" x 10J '7-double-spoke' design alloy wheels - PQF



21" x 10J '7-double-spoke' design polished alloy wheels - PQN



# Wheels and tyres

Order Code		Standard	SE	S line	S line Plus	Basic RRP	Total RRP inc VAT
PRL	19" x 8.5J '5-arm V' design alloy wheels with 265/50 R19 110Y tyres	●	S	-	-	£650.00	£780.00
PRD	19" x 8J '5-arm Structure' design alloy wheels with 265/50 R19 110Y tyres	●	-	-	-	£650.00	£780.00
PRM	20" x 9J '10-spoke V' design alloy wheels with 275/45 R20 110Y tyres	●	-	-	-	£1,304.17	£1,565.00
		-	●	-	-	£654.17	£785.00
PQS	20" x 10J '20-spoke' design two-piece alloy wheels with 295/40 R20Y tyres*	●	-	-	-	£2,041.67	£2,450.00
		-	●	-	-	£1,391.67	£1,670.00
		-	-	●	-	£337.50	£405.00
PQ5	20" x 10J '10-spoke' design alloy wheels with 295/40 R20 110Y tyres*	●	-	-	-	£2,041.67	£2,450.00
		-	●	-	-	£1,391.67	£1,670.00
		-	-	●	-	£337.50	£405.00
PQ6	21" x 10J '5-segment-spoke' design alloy wheels with 295/35 R21 tyres*	●	-	-	-	£2,512.50	£3,015.00
		-	●	-	-	£1,862.50	£2,235.00
		-	-	●	S	£808.33	£970.00
PQ8	21" x 10J '5-segment-spoke' design alloy wheels in titanium finish with 295/35 R21 tyres*	●	-	-	-	£2,595.83	£3,115.00
		-	●	-	-	£1,945.83	£2,335.00
		-	-	●	-	£891.67	£1,070.00
		-	-	-	●	£83.33	£100.00
PQF	21" x 10J '7-double-spoke' design alloy wheels with 295/35 R21Y tyres*	●	-	-	-	£2,637.50	£3,165.00
		-	●	-	-	£1,987.50	£2,385.00
		-	-	●	-	£933.33	£1,120.00
		-	-	-	●	£125.00	£150.00
PQN	21" x 10J '7-double-spoke' design polished alloy wheels with 295/35 R20 107Y tyres*	●	-	-	-	£2,979.17	£3,575.00
		-	●	-	-	£2,329.17	£2,795.00
		-	-	●	-	£1,275.00	£1,530.00
		-	-	-	●	£466.67	£560.00
3F4	Spare 18" alloy wheel with 18" 235 tyres. Only for vehicles with third seating row removed (standard UK vehicle has a third seating row)	●	-	-	-	No charge	No charge

Options are subject to availability and may extend delivery.

- = Not available  
● = Available  
S = Standard

\*Please note, this option includes a small extension to the wheel arches.

RRP – Recommended Retail Price.

VAT is calculated at 20% but this may alter to reflect any change in the applicable VAT rate.

# Packages

Some items work well together, which is why we've created these special packages. They provide increased convenience and value by combining several of our most popular options.

Options are subject to availability and may extend delivery.

- = Not available
- = Available
- S = Standard

\*Please see page 60 for more information.

RRP – Recommended Retail Price.

VAT is calculated at 20% but this may alter to reflect any change in the applicable VAT rate.

Order Code	Technology package – Low	Standard	SE	S line	S line Plus	Basic RRP	Total RRP inc VAT
WB6	▶ Satellite Navigation system – DVD-based	•	-	-	-	£1,691.67	£2,030.00
	▶ MMI Radio Plus ▶ Colour Driver's Information System with efficiency programme ▶ CD changer ▶ Audi parking system plus (front and rear) with acoustic warning and visual display on MMI monitor	-	•	•	-	£1,258.33	£1,510.00
	▶ Power-operated tailgate ▶ DSP sound system ▶ Voice dialogue system						

**Satellite Navigation system – DVD-based.** Includes MMI High and colour Driver's Information System (DIS). Integrated into the MMI is a clear map display with special destinations indicated by symbols, high-speed map loading, zoom function, bird's-eye view function, selection of address book destinations, target memory, dynamic route guidance with TMC (with vehicle life subscription), including Europe DVD (where digitised), and Satellite Navigation disc-reader located in the spare wheel well under the boot

Order Code	Technology package – High	Standard	SE	S line	S line Plus	Basic RRP	Total RRP inc VAT
WB0 9ZW UF7	▶ Satellite Navigation system – HDD-based	-	•	•	S	£1,850.00	£2,220.00
	▶ Colour Driver's Information System (DIS) with efficiency programme ▶ Single CD/DVD player ▶ Mobile phone preparation – High, with Audi connect*						
	▶ Power-operated tailgate ▶ DSP sound system ▶ Voice dialogue system ▶ Audi parking system advanced ▶ Audi Music Interface						

**Satellite Navigation system – HDD-based.** Route planning and guidance using voice, pictogram and 3D mapping. In combination with mobile telephone preparation – High, a Bluetooth capable mobile phone can be connected to the vehicle's internal UMTS module. This will then allow online services including; point of interest search and navigation with the help of Google Earth images. Online traffic information is also shown on the navigation display.\* Includes AM/FM tuner with TP memo function. Single front-loading CD/DVD player with MP3 compatibility, suitable for audio and DVD playback. Third generation MMI system including high resolution (800x400) 7" colour TFT display, two SD card readers and 40GB hard drive, 10GB of which can be used to store up to 4,000 songs. HDD navigation functionality includes advanced speech recognition, 7-digit postcode functionality, 3D and topographical mapping display and advanced 3D building display



# Packages

Options are subject to availability and may extend delivery.

- = Not available  
 • = Available  
 S = Standard

\*\*When Off-road styling package (YND) is ordered with a sunroof (3FU/3FV) and electric trailer towing hitch (1D9), deletion of third seating row (SKM) must be added.

Off-road styling package (YND) not available in combination with 20"/21" wheels with tyre size 295.

RRP – Recommended Retail Price.

VAT is calculated at 20% but this may alter to reflect any change in the applicable VAT rate

Order Code	Standard	SE	S line	S line Plus	Basic RRP	Total RRP inc VAT
<b>WB7 PV6</b> <b>Comfort package:</b> ▶ Advanced key ▶ Electrically adjustable steering column with memory ▶ Electrically adjustable front seats with memory ▶ Electrically folding, heated, auto-dimming door mirrors with memory	-	•	•	•	£1,233.33	£1,480.00
<b>WTG</b> <b>Load package:</b> ▶ Towing bracket – removable and lockable ▶ Load-securing set with rails ▶ Reversible luggage compartment mat ▶ Net partition	•	•	•	•	£708.33	£850.00
<b>YND</b> <b>Off-road styling package:**</b> ▶ Front and rear lower bumper spoilers with stainless steel under-body protection ▶ Side door lower protection strips ▶ Stainless steel running boards ▶ Wheel arch extensions ▶ Front bumper protection strips ▶ Reshaped exhaust tailpipes	•	•	-	-	£2,129.17	£2,555.00
<b>PX4 8Q7</b> <b>Visibility package:</b> ▶ Adaptive headlights ▶ Xenon Plus headlights with LED daytime-running lights and LED indicators ▶ Headlight washers	•	•	-	-	£725.00	£870.00
	-	-	•	•	£400.00	£480.00

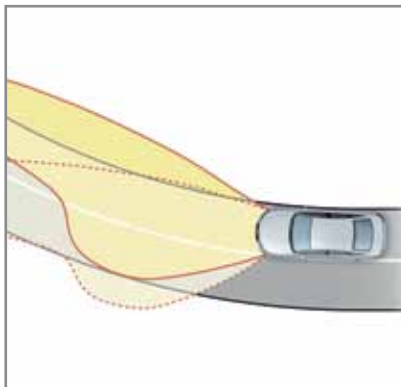

Adaptive headlights – part of visibility package



Xenon Plus headlights – part of visibility package



Off-road styling package



Colour Driver's Information System – part of technology package

# Audio and communication

Stay in touch using our range of communication functions, and give each journey its own soundtrack with our advanced audio equipment.

Options are subject to availability and may extend delivery.

– = Not available  
● = Available  
S = Standard

<sup>1</sup>To check the compatibility of your mobile phone and whether it has SIM Access Profile compatibility, please visit [www.audi.co.uk/owners-area/phone-compatibility.html](http://www.audi.co.uk/owners-area/phone-compatibility.html)

<sup>2</sup>Please note that when a data SIM card is inserted into the SIM card reader, Bluetooth handsfree connectivity is disabled, as the SIM card takes priority over the Bluetooth connection.

<sup>3</sup>Online services are only available for mobile phone contracts including a data option and only within the coverage of the mobile phone network; there may be additional costs for the use of these services (charges and billing correspond to the personal mobile phone contract). Due to high data volumes, a mobile phone contract including an unlimited data plan is strongly recommended. The content and scope of the online-based services offered may vary.

RRP – Recommended Retail Price.

VAT is calculated at 20% but this may alter to reflect any change in the applicable VAT rate

Order Code		Standard	SE	S line	S line Plus	Basic RRP	Total RRP inc VAT
<b>8DP 9VD</b>	<b>MMI Radio Plus with DSP Sound System.</b> Double tuner, 6.5" TFT colour screen (400x240) and single CD player (audio CDs only). Additional features include: two SD/HC card readers, DSP sound system and TP memo (automatic storage of traffic news). SD/HC card readers and single CD drive support MP3 and WMA formats	●	S	S	S	£433.33	£520.00
<b>QV3</b>	<b>DAB digital radio.</b> Integrated into MMI, receives digitally-transmitted radio stations in addition to the range of analogue stations. Displays music track, artist and radio program. Capable of DAB slideshow where transmitted. Also receives DAB+ and DMB audio signals. Reception dependent on local digital network. Automatic switch from DAB to FM reception if the network signal is not strong enough. Only in combination with double glazing (4K5/VW8) and MMI Radio Plus (8DP/9VD)	●	●	●	●	£295.83	£355.00
<b>8RY</b>	<b>BOSE® surround sound system.</b> Dynamic noise-compensation, 8-channel amplifier, 13 loudspeakers including centre speaker in the dashboard and 2 surround loudspeakers in the rear shelf. Total output of 330 Watts. 5-channel surround sound. On Standard trim only in combination with MMI Radio Plus (8DP/9VD)	●	●	●	●	£487.50	£585.00
<b>8RF</b>	<b>Bang &amp; Olufsen Advanced Sound System.</b> Surround sound reproduction with dynamic compensation for road noise. 5-channel amplifier; 14 loudspeakers with total output of 1,000 Watts, motorised Acoustic Lens speakers in dashboard, aluminium loudspeaker grilles for all other visible speakers, 14-channel Digital Signal Processing (DSP). Four different settings are available to adapt sound to the seat positions. Only in combination with 4-zone climate control and Technology package – High (WB0). Not available on 3.0 TDI with Start-Stop technology	–	●	●	●	£3,829.17	£4,595.00
<b>9ZX</b>	<b>Mobile telephone preparation – Bluetooth interface.</b> Provides handsfree connection via Bluetooth using mobile phone aerial. Please contact your Audi Centre for phone compatibility. Only in combination with MMI Radio Plus (8DP/9VD)	●	S	S	–	£208.33	£250.00
<b>PT5</b>	<b>Mobile telephone preparation – Low with Bluetooth and voice control.</b> Provides handsfree connection via Bluetooth using mobile phone aerial. Alternatively, it can use a cradle with charging facility for optimal reception via external aerial. Located in front centre armrest. Cradle available at extra cost – please contact your Audi Centre for phone compatibility. Only in combination with Technology package – Low (WB6)	●	–	–	–	£466.67	£560.00
		–	●	●	–	£129.17	£155.00
<b>9ZW</b>	<b>Mobile telephone preparation – High with Audi connect.</b> A mobile phone can be connected to the internal UMTS (3G) module via Bluetooth (provided the mobile telephone has SIM Access Profile <sup>1</sup> ), or alternatively through the additional SIM card reader <sup>2</sup> . It is possible to transfer phone book entries to the car and manage call lists. Audi connect features include: navigation using Google Earth images and Google Street View, destination entry via Google Maps or myAudi, online point of interest search and information services such as weather forecasts and the latest world news. Audi connect also includes Audi traffic information online, which gives accurate real-time forecasts of the traffic situation along the chosen route. The traffic situation can be displayed on the navigation map or Google Earth image. Audi connect can also create a Wi-Fi hotspot in the car for convenient internet access using a mobile device (e.g. laptop or tablet) <sup>3</sup> . Many Audi connect features can be simply operated via MMI Navigation Plus, the multi-function steering wheel or the voice control system. Only in combination with a Technology package (WB6/WB0)	●	●	●	S	£291.67	£350.00

# Audio and communication

Order Code		Standard	SE	S line	S line Plus	Basic RRP	Total RRP inc VAT
UF7	<b>Audi Music Interface (AMI).</b> Universal connection for use with stereo audio sources, USB and MP3 devices including Apple iPod generation 4 onwards (iPod, iPod classic, iPod mini, iPod nano, iPod photo, iPod video, iPod touch). Provides intuitive control through the audio system and multi-function steering wheel. It also replicates the iPod display on the audio screen and DIS, including track titles. The interface provides charging function (dependent on device). Includes 2 cables to connect your iPod or USB MP3 player device. Only in combination with MMI Radio Plus (8DP/9VD)	●	●	●	S	£212.50	£255.00
7A6 7D1	<b>CD changer.</b> For six CDs with MP3 compatibility. Operated via MMI system. Located in centre console. When ordered with MMI system, a single CD player is fitted under the centre armrest	●	●	●	●	£270.83	£325.00
9Q8	<b>Driver's Information System (DIS) – colour.</b> With efficiency programme	●	●	●	S	£108.33	£130.00
9WM	<b>Audi Entertainment Mobile.</b> Includes two 9-inch screens* supplied by Audi Genuine Accessories which can be easily fitted and includes the ability to connect modern storage devices such as Bluetooth interface, CD/DVD-drive, SD-card slot, USB-interface and AV-IN/OUT. Includes a carry case for player and accessories, remote control, table-top stand, battery for 2.5 hours external player time, charging lead, head phones, operating instructions and a bonus DVD. The back of both front seats are fitted with mountings and wiring and the system can also be used outside the car with the rechargeable battery	●	●	●	●	£875.00	£1,050.00
9WP FE2	<b>Rear Seat Entertainment System Plus.</b> Comprising 6-disc DVD player in luggage compartment, 2x7" monitors in the front head restraints with separate TV/DVD/AUX input for each screen, connections for AUX input such as games console, sound output through vehicle sound system or headphones and analogue and digital TV reception. Includes two sets of headphones. This option deletes the standard collapsible spare wheel and replaces it with tyre mobility system. Only in combination with Technology package – High (WB0) and TV reception (QU6/QU7) and BOSE® surround sound system (8RY) on engines with start-stop technology	–	●	●	●	£3,575.00	£4,290.00
QU7	<b>Digital TV reception.</b> TV tuner for reception of 'free-to-air' TV channels. Picture display only possible on MMI screen when vehicle is stationary, audio available at all times. Reception dependent upon local digital network availability. Only in combination with Technology package – High (WB0)	–	●	●	●	£670.83	£805.00
QU6	<b>Digital Radio and TV reception.</b> TV tuner for reception of 'free-to-air' TV channels. Picture display only possible on MMI screen when vehicle is stationary, audio available at all times. Reception dependent upon local digital network availability. Only in combination with Technology package – High (WB0) and double glazing (4KS/VW8)	–	●	●	●	£966.67	£1,160.00

Options are subject to availability and may extend delivery.

- = Not available
- = Available
- S = Standard

\*Screens must be ordered by the Audi Centre via Audi Genuine Accessories.

RRP – Recommended Retail Price.

VAT is calculated at 20% but this may alter to reflect any change in the applicable VAT rate

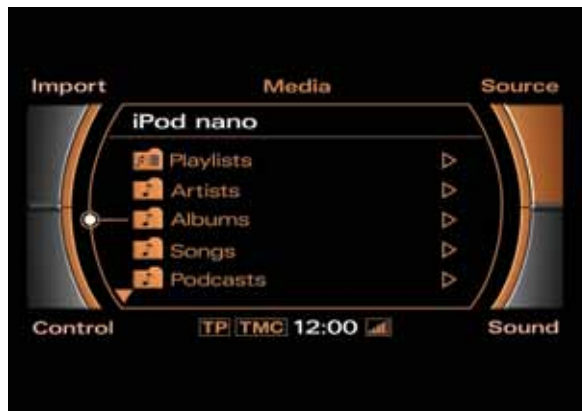

Audi Music Interface



Bang & Olufsen Advanced Sound System



Rear Seat Entertainment

# Interior equipment

Specify every detail of your car's interior with this range of exclusive options.

Order Code		Standard	SE	S line	S line Plus	Basic RRP	Total RRP inc VAT
8T4	<b>Adaptive cruise control (ACC).</b> Automatic distance regulation, using radar sensors to maintain required distance by braking and accelerating. Four programs (distance 1 to distance 4) set via steering column controls of the cruise control system. Works at speeds between 0 and 120mph and also includes Audi braking guard – a system which triggers a visual and acoustic alarm when it detects the risk of a rear-end collision with the vehicle in front. Includes colour Driver's Information System. Only in combination with a Technology package (WB6/WB0)	●	●	●	●	£937.50	£1,125.00
4F2	<b>Advanced key.</b> Access and authorisation system which automatically exchanges data between key and vehicle, allowing the driver to keep the key in their pocket or bag at all times. To unlock and open, simply lift the exterior door handle. To lock, press the button on the handle. Pressing the start/stop button integrated in the centre console starts and stops the engine	●	●	●	●	£812.50	£975.00
6NQ	<b>Cloth headlining – black.</b> Only in combination with upholstery codes CA, FP, FQ or FR	●	●	S	S	£212.50	£255.00
PL6	<b>Alcantara headlining –</b> with contrast stitching and retractable sun visors. The headlining is in light grey or linen beige depending on interior chosen. When ordered with S line interiors the headlining is light grey	●	●	–	–	£937.50	£1,125.00
		–	–	●	●	£725.00	£870.00
PL2	<b>Alcantara headlining – black,</b> with light grey stitching. Also includes retractable sun visor	●	●	–	–	£1,487.50	£1,785.00
		–	–	●	●	£1,275.00	£1,530.00
6E6	<b>Comfort front centre armrest.</b> Separated for driver and front passenger with fold-up storage compartment on the driver's side. Also includes a cup holder on the passenger's side and further cup holders in the armrest on the passenger's side (folding), with storage compartment under the centre armrest	●	S	S	S	£129.17	£155.00
9AH	<b>Deluxe automatic air conditioning at the rear.</b> Temperature settings and air distribution can be adjusted at the rear on the C pillar outlets. Passengers can adjust rear air conditioning via controls in the centre console at rear or via air-conditioning controls at front	●	●	●	●	£466.67	£560.00
2C7	<b>Electrically adjustable steering column.</b> Adjustment for height and reach with auto easy-entry-and-exit function	●	●	●	●	£254.17	£305.00
PAD	<b>Folding tables on the front seat backrests</b>	●	●	●	●	£66.67	£80.00
VC1	<b>Garage door opener (Homelink®*).</b> Programmable radio-operated remote control for compatible doors/gates. Control buttons integrated in the front roof module	●	●	●	●	£150.00	£180.00
7HB	<b>Leather package.</b> Includes front centre console, door armrest and door handles in Fine Nappa leather	–	●	●	●	£595.83	£715.00
7HD	<b>Leather package advanced.</b> As leather package plus dashboard and door shoulder line in Fine Nappa leather. Only in combination with Alcantara headlining (PL2/PL6), manual blinds (3Y3) and visibility package (8Q7/PX4). On SE models stitching is in Silver, on S line models stitching is in Black	–	●	●	●	£3,829.17	£4,595.00
QQ1	<b>Light package.</b> Includes front and rear footwell lighting and ambient lighting of the centre console with LED technology, active door reflectors, puddle lights under the exterior mirrors, rear door exit lights, illuminated air vents in the B pillar and ashtray in the rear	●	S	S	S	£150.00	£180.00

Options are subject to availability and may extend delivery.

– = Not available  
● = Available  
S = Standard

\*HomeLink® is a registered trademark of Johnson Controls. For information on compatibility, visit [www.homelink.com](http://www.homelink.com).

RRP – Recommended Retail Price.

VAT is calculated at 20% but this may alter to reflect any change in the applicable VAT rate

# Interior equipment

Order Code		Standard	SE	S line	S line Plus	Basic RRP	Total RRP inc VAT
3GN	<b>Load-area fixing kit.</b> Includes telescopic bar and securing belt for dividing up luggage compartment	●	●	●	●	£170.83	£205.00
9JA	<b>Non-smoking pack.</b> Replaces ashtray and cigarette lighter with 12V socket and centre storage compartment. Ashtrays in rear door armrests unchanged	●	●	●	●	No charge	No charge
3Y3	<b>Rear window and side window blinds – manual</b>	●	●	●	●	£175.00	£210.00
3CX	<b>Removable net partition.</b> Located between rear seats and rear luggage compartment. Can be used with rear seat-back in upright position, one side folded down, or completely folded down	●	●	●	●	£87.50	£105.00
6SJ	<b>Reversible load floor mat.</b> Luggage compartment floor mat can be reversed to provide a rubber mat which extends to protect rear bumper. Includes bumper cover	●	●	●	●	£70.83	£85.00

Options are subject to availability and may extend delivery.

- = Not available
- = Available
- S = Standard

RRP – Recommended Retail Price.

VAT is calculated at 20% but this may alter to reflect any change in the applicable VAT rate



Load-securing set with rails



Leather package advanced



Cool box



Advanced key start/stop button

# Seats

Choose from a variety of different seat options so you can maintain the right driving posture at all times.

Order Code		Standard	SE	S line	S line Plus	Basic RRP	Total RRP inc VAT
<b>4A3</b>	<b>Heated front seats.</b> Individually controlled with variable temperature adjustment	●	S	S	S	£254.17	£305.00
<b>4A4</b>	<b>Heated front and rear seats.</b> Individually controlled with variable temperature adjustment	●	—	—	—	£466.67	£560.00
		—	●	●	●	£212.50	£255.00
<b>PV1</b>	<b>Electrically-adjustable front seats.</b> Includes adjustment for height, forwards and backwards position, backrest angle and lumbar support	●	S	S	S	£725.00	£870.00
<b>PV6 6XL</b>	<b>Electrically adjustable front seats with driver and front passenger seat memory.</b> Includes adjustment for height, forwards and backwards position, backrest angle and lumbar support, as well as memory for electrically adjusted steering column, if fitted. Also includes electrically folding, heated, auto-dimming door mirrors with memory	●	—	—	—	£1,220.83	£1,465.00
		—	●	●	●	£512.50	£615.00
<b>7P1</b>	<b>Electric lumbar support</b> for front seats with horizontal and vertical adjustment	●	S	S	S	£191.67	£230.00
<b>5KM</b>	<b>Deletion of third seating row</b>	●	●	●	●	No charge	No charge
<b>3X2</b>	<b>Through-load facility.</b> Includes removable ski bag for transporting long objects	●	●	●	●	£129.17	£155.00

Options are subject to availability and may extend delivery.

- = Not available
- = Available
- S = Standard

RRP – Recommended Retail Price.

VAT is calculated at 20% but this may alter to reflect any change in the applicable VAT rate



7-seat configuration



# Exterior equipment

Make sure your car looks exactly as you want it to by selecting some of our striking options.

Order Code		Standard	SE	S line	S line Plus	Basic RRP	Total RRP inc VAT
4ZM	<b>Black styling package.</b> Includes radiator grille, window surround and number plate holder in matt black, radiator grille frame in high-gloss black, and black roof rails	—	●	●	●	£383.33	£460.00
2Z7	<b>Deletion of engine capacity designation at rear</b>	●	●	●	●	No charge	No charge
2Z0	<b>Deletion of model and engine capacity designation at rear</b>	●	●	●	●	No charge	No charge
6XK	<b>Door mirrors – electrically folding, heated and auto-dimming</b>	●	●	●	●	£137.50	£165.00
PAP	<b>Full paint finish and chrome package.</b> Bumpers are painted in body colour with matt finish	—	●	—	—	£520.83	£625.00
3FU	<b>Panoramic sunroof.</b> Large 3-piece panoramic glass sunroof, extending to the third row of seats. Electrical operation for tilting and opening the front glass section, tinted glass insert, adjustable sun shield above the whole glass surface, electrically adjustable at front, manually adjustable at rear. Automatic close function from outside via central-locking*	●	●	●	●	£1,275.00	£1,530.00
3FV	<b>Panoramic sunroof dark tinted.</b> Large 3-piece panoramic glass sunroof, extending to the third row of seats. Electrical operation for tilting and opening the front glass section, tinted glass insert, adjustable sun shield above the whole glass surface, electrically adjustable at front, manually adjustable at rear. Automatic close function from outside via central-locking*	●	●	●	●	£1,358.33	£1,630.00
4E9	<b>Power-operated tailgate.</b> Opens by pressing button on the car key, button in the driver's door trim or soft-touch button in the handle recess on the luggage compartment lid. Including lid-closing assistance unit and programmable angle for the luggage compartment lid	●	●	●	S	£320.83	£385.00
YNB	<b>Stainless steel running boards**</b>	●	●	●	S	£595.83	£715.00
1D9	<b>Towing bracket – electrically folding.</b> Electrically folding ball head operated via button in the luggage compartment, including trailer stabilisation via the Electronic Stability Programme. Includes single 13-pin electric socket. Please contact your local Audi Centre if you require a 13- to 7-pin adaptor. Not available on 3.0 TDI clean diesel*	●	●	●	●	£725.00	£870.00
	In combination with load package (WTG)	●	●	●	●	£170.83	£205.00
1D2	<b>Towing equipment – removable.</b> Factory-fitted and removable. Includes single European 13-pin electric socket and may require a 13- to 7-pin adaptor. Please consult your Audi Centre for details*	●	●	●	●	£554.17	£665.00

Options are subject to availability and may extend delivery.

– = Not available  
● = Available  
S = Standard

\*Additional wiring is required for auxiliary equipment

\*\*When ordering Stainless steel running boards (YNB) with a Sunroof (3FU/3FV) and Electric trailer towing hitch (1D9) then Deletion of third seating row (5KM) must be added.

RRP – Recommended Retail Price.

VAT is calculated at 20% but this may alter to reflect any change in the applicable VAT rate

# Safety and security

Intelligent technology designed to give you better all-round awareness and safety on the road.

Order Code		Standard	SE	S line	S line Plus	Basic RRP	Total RRP inc VAT
7X2	<b>Audi parking system plus.</b> Aids parking by acoustically and visually indicating distances to obstacles	●	●	●	—	£270.83	£325.00
KA2 7X2	<b>Audi parking system advanced with reversing camera.</b> Aids parking by acoustically and visually indicating distances to obstacles with guiding lines. Measured by sensors and reversing. Only in combination with MMI Radio Plus (8DP/9VD)	●	●	●	S	£554.17	£665.00
PU1	<b>Audi lane assist.</b> Uses a discreet camera mounted at the top of the windscreen to monitor the road ahead. The driver is warned with a vibration of the steering wheel if the vehicle is about to exit its lane unintentionally. Only available in combination with a 4-spoke multi-function steering wheel. Not available in combination with Audi exclusive line (WQ7/YED). S line badging and stitching are not available. Not available in combination with 4-spoke multi-function leather/wood steering wheel with gear-shift paddles (Z2S)	●	●	●	●	£341.67	£410.00
7Y1	<b>Audi side assist.</b> Aids the driver when changing lane. Audi side assist monitors the area behind your car using radar sensors located discreetly in the rear bumper, informing the driver with a visual warning signal in the door mirror if there is a vehicle in their blind spot or approaching quickly from behind. The system is activated using a button in the driver's door. Not available on S line models with exclusive line upholstery. To order side assist and lane assist in combination please use order code PU2	●	●	●	●	£383.33	£460.00
4KF	<b>Privacy glass.</b> Dark tinted glass from B-pillar backwards. Not available in combination with double glazing (4KS/VW8)	●	●	●	S	£316.67	£380.00
VW8	<b>Double glazing.</b> Windscreen and side windows in 2-layer laminated safety glass, connected to each other by a plastic film. Improves insulation against outside noise and adds break-in protection. Not available in combination with privacy glass (4KF/ 4KS)	●	●	●	—	£445.83	£535.00
4KS	<b>Double glazing with Privacy glass.</b> Windscreen and side windows in laminated safety glass, 2 layers, which are connected to each other by a plastic film. Improves insulation against outside noise and adds break-in protection. Dark tinted rear and rear side windows	●	●	●	—	£762.50	£915.00
		—	—	—	●	£445.83	£535.00
8N7	<b>High-beam assist.</b> Automatically adjusts headlights from high-beam to dipped-beam when another vehicle is approaching	—	●	●	●	£95.83	£115.00
4X4	<b>Rear side airbags.</b> Situated in side of rear seats	●	●	●	●	£212.50	£255.00
7K6	<b>Tyre pressure loss indicator.</b> A visual and acoustic warning when the system detects a potential loss of tyre pressure	●	●	●	●	£70.83	£85.00

Options are subject to availability and may extend delivery.

— = Not available  
● = Available  
S = Standard

RRP – Recommended Retail Price.

VAT is calculated at 20% but this may alter to reflect any change in the applicable VAT rate

# Steering wheels

You can choose from a selection of advanced leather multi-function steering wheels, allowing you to control your audio system at the touch of a button.

Order Code		Standard	SE	S line	S line Plus	Basic RRP	Total RRP inc VAT
<b>1XX</b>	<b>3-spoke multi-function steering wheel with gear-shift paddles.</b> Includes S line badging on S line models only	●	●	S	S	£179.17	£215.00
<b>2ZD</b>	<b>4-spoke multi-function leather steering wheel – heated, with gear-shift paddles.</b> Only in combination with seat heating (4A3/4A4) and Audi lane assist (PU1/PU2). Not available in combination with Audi exclusive line (WQ7/YED) or Audi exclusive steering wheel in wood and leather (YRI)	●	●	●	●	£225.00	£270.00
<b>2Z5 6F9</b>	<b>4-spoke multi-function leather/wood steering wheel with gear-shift paddles.</b> Only in combination with Walnut natural inlays (5TS). Not available in combination with Audi exclusive line (WQ7/YED)	●	●	–	–	£450.00	£540.00

Options are subject to availability and may extend delivery.

- = Not available
- = Available
- S = Standard

RRP – Recommended Retail Price.

VAT is calculated at 20% but this may alter to reflect any change in the applicable VAT rate.



# Audi Complete

Audi Complete is simply a way to look after the servicing and maintenance costs for your Audi in a single package. You pay a one-off or monthly fee and we'll cover all your servicing, maintenance and tyres for the next three years including your first MOT. It means you only have to pay for fuel, insurance and your Road Fund Licence. So you can be reassured that your car will be maintained by trained Audi Technicians, using genuine Audi parts.

\*Retail customers only. Pricing based on 3 years/30,000 miles (whichever occurs sooner). All pricing is a 'starting from' price for the Audi Q7 model range and is therefore subject to change and mileage/model dependent.

# Warranty

Options are subject to availability and may extend delivery.

- = Not available
- = Available
- S = Standard

\*\*Only available prior to registration of your Audi Q7. Please speak to your Audi Centre for full details.

RRP – Recommended Retail Price.

VAT is calculated at 20% but this may alter to reflect any change in the applicable VAT rate

Order Code		Q7	Basic RRP	Total RRP inc VAT
-	<b>Audi Complete – Service and Maintenance.</b> Comprehensive care for your Audi covering all your servicing and maintenance for 3 years, as well as your first MOT. Visit your local Audi Centre for further information or <a href="http://audi.co.uk/audicomplete">audi.co.uk/audicomplete</a> for full details including terms and conditions	●	£24.17	£29.00*
-	<b>Audi Complete – Service, Maintenance and Tyres.</b> Comprehensive care for your Audi covering all your servicing, maintenance and tyres for 3 years, as well as your first MOT. Visit your local Audi Centre for further information or <a href="http://audi.co.uk/audicomplete">audi.co.uk/audicomplete</a> for full details including terms and conditions	●	£39.17	£47.00*

Order Code		Q7	Basic RRP	Total RRP inc VAT
-	<b>Audi Warranty,</b> covering you for unlimited mileage in the first two years of ownership, and up to 60,000 miles in the third year. Transferable between owners**	S	No charge	No charge
EA6	<b>Audi Warranty,</b> covering you for up to 4 years or 75,000 miles, whichever comes soonest. Cover includes a two-year unlimited mileage warranty, and up to 75,000 miles in the third and fourth years. Transferable between owners**	●	£466.67	£560.00
EA9	<b>Audi Warranty,</b> covering you for up to 5 years or 90,000 miles, whichever comes soonest. Cover includes a two-year unlimited mileage warranty, and up to 90,000 miles in the third, fourth and fifth years. Transferable between owners**	●	£1,112.50	£1,335.00

# Merchandise

From the enthusiasts' motorsport collection to the sophisticated Audi collection, there's a wide variety of adults' and children's clothing, lifestyle accessories and collectables, all of which bear the Audi name.

Please speak to a member of our team at your local Audi Centre to see the full Audi collection and to place an order. A selection of Audi merchandise is also available to buy from [audi.co.uk/merchandise](http://audi.co.uk/merchandise).



# Accessories

Choosing an Audi isn't just a matter of deciding on the model you want; it's about creating a car that suits your needs perfectly. And that's why we've developed a whole range of accessories to enhance your Audi Q7, enabling you to customise it down to the last detail. Like your Audi, all these accessories are developed to the highest possible standards. And they're all available exclusively from Audi.

To find out more, just visit [audi.co.uk/accessories](http://audi.co.uk/accessories) or contact your local Audi Centre.

## Warranty

All the accessories available on the Audi Q7 are covered by a three-year warranty\* if they are ordered and included in the purchase price of the car at date of delivery. Any accessories ordered and installed after delivery include a two-year warranty.\*

\*Excluding Road Angel products.  
Audi Accessories warranty terms and conditions can be found at [audi.co.uk](http://audi.co.uk)



# Audi Q7

## technical data

Engine	Petrol			Diesel		
	3.0 TFSI quattro	3.0 TFSI quattro	3.0 TDI quattro	3.0 TDI quattro	3.0 TDI quattro clean diesel	4.2 TDI quattro
Transmission	8-speed tiptronic	8-speed tiptronic	8-speed tiptronic	8-speed tiptronic	8-speed tiptronic	8-speed tiptronic
Cylinder	6-cylinder	6-cylinder	6-cylinder	6-cylinder	6-cylinder	8-cylinder
Displacement, cubic cm (valves per cylinder)	2995 (4)	2995 (4)	2967 (4)	2967 (4)	2967 (4)	4134 (4)
Max. power <sup>1</sup> , PS at rpm	272/4750-6500	333/5500-6500	204/3200-4400	245/3800-4400	245/3800-4400	340/4000
Max. torque, Nm at rpm	400/2250-4750	440/2900-5300	450/1250-2750	550/1750-2500	550/1750-2750	800/1750-2750
0-62mph acceleration, seconds	7.9	6.9	9.1	7.8	8.0	6.4
Top speed <sup>2</sup> , mph	140	152	127	135	135	150
CO <sub>2</sub> emissions <sup>3</sup> , g/km	249	249	189	195	195	242
Benefit in kind (BIK)%	35%	35%	30%	32%	32%	35%
Fuel consumption <sup>3</sup> , mpg (l/100km) Urban	19.6 (14.4)	19.6 (14.4)	34.4 (8.2)	32.8 (8.6)	32.1 (8.8)	23.5 (12.0)
Fuel consumption <sup>3</sup> , mpg (l/100km) Extra Urban	33.2 (8.5)	33.2 (8.5)	43.5 (6.5)	42.2 (6.7)	42.8 (6.6)	37.2 (7.6)
Fuel consumption <sup>3</sup> , mpg (l/100km) Combined	26.4 (10.7)	26.4 (10.7)	39.2 (7.2)	38.2 (7.4)	38.2 (7.4)	30.7 (9.2)
ABI insurance group 1-50*	41 E	43 E	37 E	41 E	41 E	46 E
Unladen weight <sup>4</sup> , kg	2250	2240	2300	2300	2350	2440
Gross weight limit, kg	3075	2965	3125	3125	3175	3265
Roof load limit/nose weight, kg	100/130	100/130	100/130	100/130	100/130	100/130
Max trailer load unbraked <sup>5</sup> , kg	750	750	750	750	750	750
Max trailer load with 12% gradient <sup>5</sup> , kg	3200	3200	3200	3200	3200	3200
Max trailer load with 8% gradient <sup>5</sup> , kg	3200	3200	3200	3200	3200	3200
Luggage compartment capacity/seats folded flat, litres	765/2035	775/2035	765/2035	765/2035	765/2035	765/2035
Fuel tank capacity approx, litres	100	100	100	100	100	100

\*Highest insurance group rating shown. Group may be lower dependent on trim level. Please visit [www.thatcham.org/abigrouprating](http://www.thatcham.org/abigrouprating) for details.

<sup>1</sup>The given values were obtained in accordance with the specified measurement procedure (the respective current version of the Directive 80/1269/EEC).

<sup>2</sup>Top speed is achieved in 6th gear.

<sup>3</sup>Fuel consumption and CO<sub>2</sub> emissions figures are obtained under standardised test conditions (Directive 93/116/EEC) using a representative model. This allows direct comparison between different models from different manufacturers, but may not represent the actual fuel consumption achieved in 'real world' driving conditions. More information is available at [www.vca.gov.uk](http://www.vca.gov.uk).

<sup>4</sup>Vehicle's unladen weight without driver (calculated in accordance with the current version of Directive 92/21/EEC). The fitting of additional equipment may increase the vehicle's unladen weight and drag coefficient, whereupon the potential carrying capacity and top speed will be correspondingly reduced.

<sup>5</sup>The engine's power output always goes down with increasing altitude. At 1,000m above sea level, and for every additional 1,000m, deduct 10% from the weight of the outfit (trailer load limit + gross weight of the towing vehicle). Value applies to trailer load for factory-fitted trailer towing hitch.

# Audi Q7 dimensions

The technical drawings opposite show the exact dimensions of the Audi Q7, so you can check everything – from whether the car will fit in your garage to whether your luggage will fit in the boot.

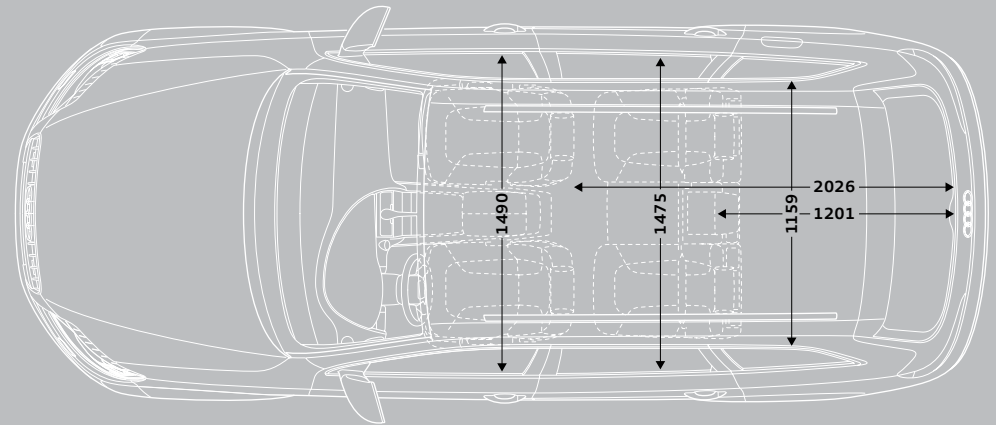
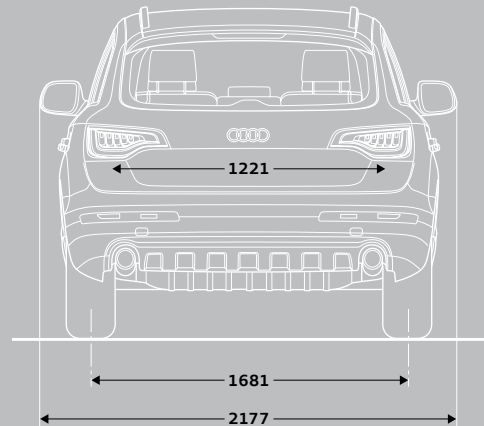
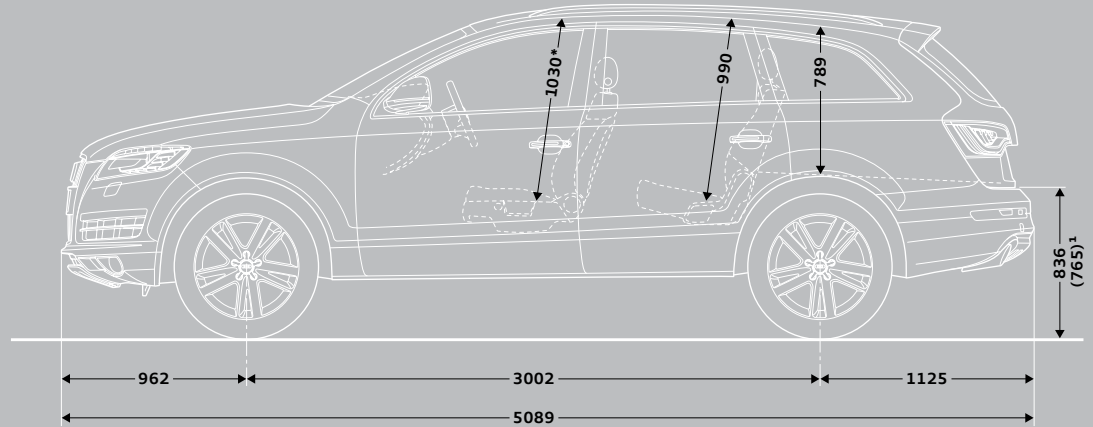
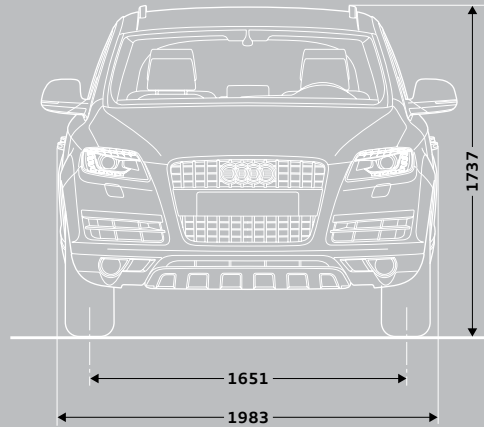

Dimensions in millimetres.

\*Maximum headroom.

Dimensions were measured with vehicle at unladen weight, ground clearance measured with vehicle carrying its maximum load. Luggage load area in litres: 775/2035 (Measured by the VDA standard test method using 200 x 100 x 50mm blocks. Second value is with the rear seat folded down and the vehicle loaded up to the roof height).

Turning circle approx 12m

¹ With air suspension, in lift mode.



# Additional information

## CO<sub>2</sub> data and information

### CO<sub>2</sub> emissions-based Vehicle Excise Duty

Vehicle Excise Duty (Road Fund Licence) is based upon the amount of Carbon Dioxide (CO<sub>2</sub>) a vehicle emits, measured in grams per kilometre (g/km).

First year VED rates apply to the first year of ownership. Annual VED rates apply thereafter. The DVLA has created thirteen categories:

Petrol and Diesel engines	First year	Annual rate (second year onwards)
A – up to 100g/km	£0.00	£0.00
B – 101 to 110g/km	£0.00	£20.00
C – 111 to 120g/km	£0.00	£30.00
D – 121 to 130g/km	£0.00	£100.00
E – 131 to 140g/km	£120.00	£120.00
F – 141 to 150g/km	£135.00	£135.00
G – 151 to 165g/km	£170.00	£170.00
H – 166 to 175g/km	£275.00	£195.00
I – 176 to 185g/km	£325.00	£215.00
J – 186 to 200g/km	£460.00	£250.00
K – 201 to 225g/km	£600.00	£270.00
L – 226 to 255g/km	£815.00	£460.00
M – over 255g/km	£1,030.00	£475.00

Vehicle Excise Duty (VED) rates correct at time of going to print, but these may alter to reflect any change in the applicable VED rate

### Servicing tailored to your needs

Regular servicing is key to safeguarding your Audi's performance and a full Audi service history could help you preserve the future re-sale value. To make servicing easy, the Audi Service Schedules have been designed to work with your individual driving style and vehicle.

There are two schedules available and your Audi Centre will advise which schedule is most suited to your needs. The conventional fixed Audi Inspection Service schedule has fixed intervals for the Oil-change and Inspection Service that are based on

time and distance, whichever comes first. With the Audi LongLife Service schedule, sensors take account of driving style and conditions in which the vehicle is used to indicate when the Oil-change Service is required. Oil-change Service intervals are therefore variable and are conveniently indicated via the on-board service interval display.

### Audi Complete

Your vehicle should be placed on the following service schedules dependent on your mileage per annum:

- ▶ Under 10,000 miles per annum – Fixed Inspection Service Schedule
- ▶ Over 10,000 miles per annum – LongLife Service Schedule

#### Fixed Inspection Service Schedule

	Vehicle usage:
Mileage	Less than 10,000 miles per annum
Type of journey	Mainly city/town centre driving. Short journeys
Conditions	Frequent cold starts. High engine loading – e.g. frequent hill climbs, vehicle fully loaded, towing
Driving style	Uneconomical – e.g. heavy acceleration, heavy braking, constant changes in speed, constant use of high revs, 'sporty' driving
	Service Intervals:
Oil-change Service	Fixed to every 9,000* miles/1 year
Inspection Service	Fixed to every 19,000* miles/2 years

#### Variable LongLife Service Schedule

	Vehicle usage:
Mileage	More than 10,000 miles per annum
Type of journey	Motorway and main road driving. Mainly longer distance journeys. Constant speeds
Conditions	Normal engine loading – e.g. with little or no towing, with little or no hill climbs. Normal vehicle loading
Driving style	Moderate acceleration, moderate braking, engine revs mainly below 3,000
	Service Intervals:
Oil-change Service	Variable to a maximum of every 19,000* miles/2 years
Inspection Service	Fixed to every 19,000* miles/2 years

\*As indicated by the service interval display. Mileages are approximate as the Service Indicator system uses kilometres as its distance measurement.

# Additional information

## Welcome to Audi

By placing an order for your Audi, you're choosing to get behind the wheel of one of the most sophisticated cars on the road. And because we believe the service we offer should be just as advanced, we wanted to let you know exactly what you can expect from us, now and in the future.

We've agreed a set of standards with all our Centres, which governs the way we do business with you. It outlines the kind of service we promise to deliver for every customer, right down to filling each new Audi we sell with half a tank of fuel.

So whether you're interested in the date your car will arrive in the UK or the way we'll dispose of non-biodegradable materials after we service your Audi, you can have total confidence in us.

## Audi Promise

### Audi Centres

We guarantee that all our Centres will be open as follows:

Sales: Monday to Friday 9am–6pm  
Saturday 9am–5pm

Service: Monday to Friday 8am–6pm  
Saturday 8.30am–1pm

Sunday opening is at local discretion.

### New car delivery

Once we've confirmed a delivery date for your car, we'll keep you informed of progress. Subject to reasonable notice, we'll then deliver it to a place of your choice, whether that's your home or work. In the unlikely event of a delay, we'll provide a courtesy car to minimise inconvenience and keep you mobile.

### The experts in Vorsprung durch Technik

Would you entrust your Audi to anyone who hasn't been regularly trained to Audi standards? Our Audi Approved Master Technicians have undergone an impressive 100,000 hours of training over a 10-year programme to ensure they have the latest technical expertise for maintaining and servicing your Audi. All our Service Advisors undergo a specialist induction and training to ensure they are Audi professionals and able to talk to you about any issues you may have with your Audi vehicle. What's more, we have so much expertise and experience in looking after Audi vehicles that we are able to make a note of your mileage and the state of your vehicle as and when we see it and predict when certain key events may occur. As part of our commitment to you, we will notify you in plenty of time so you can make an appointment with us.

### Your convenience comes first

At Audi you can choose from a range of convenient services that suit your needs. Why not book a 'service while you wait' appointment\* and enjoy our complimentary refreshments while your car is with us? Or, if you need to be mobile, take advantage of one of our courtesy cars which we can even collect and deliver to you.\* We guarantee we can service your Audi within 5 days without a courtesy car, or within 10 days if you need transport. We will also ensure your car is returned to you with a full valet.

### Audi Genuine Parts

Would you put a part into your Audi that wasn't the same quality as the factory fitted original? You can rest assured that only Audi Genuine Parts will be used on your vehicle. What's more, Audi parts and labour come with a 2-year guarantee.\*\* We stock a wide variety of parts, so we are well covered. However, if we don't have a part in stock at our Centre we have the back-up of parts at other Audi Centres, at our national warehouse and our factory and can usually source the relevant part very quickly.

### We don't like surprises either

We believe strongly in transparency and there will be no hidden costs. For added peace of mind, we will give you a quotation over the phone for the work you have requested and email you the price confirmation. We'll consult you if any additional work on your car is needed when it is with us. We won't carry out any extra work without asking your permission first.

### The Audi Stamp

Regular servicing is key to safeguarding your Audi's performance and a full Audi service history could help you preserve the future re-sale value of your car. Only the Audi Stamp will prove your approved Audi service history.

### Getting better every time

We continually gather feedback from our Audi Trained Technicians, as well as our customers, to ensure our vehicles are running as they should. Whenever we see an Audi for a service, we connect it directly to our headquarters in Ingolstadt which enables us to check your car's software and make sure it's as up-to-date as possible. If the factory has released a software upgrade for your model, it can be applied immediately – improving anything from your car's efficiency to the precision of its parking system.

### Environmental commitment

We promise to dispose of all non-biodegradable materials from your vehicle in a responsible manner.

\*Subject to availability.

\*\*Excludes wear and tear.

# Pricing information

## Pricing

Prices and specifications given are correct at the time of printing. Always check details with your Audi Centre, as Audi policies are continually developing. We reserve the right to change prices or specifications at any time.

All prices are subject to VAT, currently charged at 20% but this may alter to reflect any change in the applicable VAT rate.

Delivery charges and number plates are not included in the vehicle price.

Delivery charge	£471.66
Number plate	£20.00
VAT	£98.34
Total	£590.00

## Audi Roadside Assistance

Your new car comes complete with 3 years' complimentary roadside assistance and recovery across the UK provided by RAC Motoring Services. Also included is roadside assistance throughout Europe, managed by RAC Motoring Services.

For further information and terms and conditions please visit [audi.co.uk](http://audi.co.uk)

## Audi Customer Care

Every new Audi benefits from the comprehensive Audi Customer Care Package, which comprises:

- ▶ A 3-year Audi warranty, which covers you for unlimited mileage in the first 2 years of ownership, with a full mechanical and electrical warranty which covers you for up to 60,000 miles in the 3rd year

- ▶ A 3-year paint warranty
- ▶ A 12-year anti-corrosion warranty
- ▶ 3 years' UK roadside assistance and recovery

You also have the option when ordering your new car of choosing a 4-year or 5-year Audi warranty. Speak to a member of the sales team for more information.

## Audi Tax-Free Sales

If you are entitled to purchase a vehicle free of VAT, normally through Military or Diplomatic privilege, please contact your local Audi Centre for full details.

Should you have any difficulty obtaining the information you require, please call Freephone 0800 585878.

## Audi Finance

Audi Finance specialise in providing funding solutions for Audi drivers. Whether your Audi is for private or business use, there are a range of funding options to choose from.

Below is the full range of finance products.

- ▶ Solutions – a Personal Contract Plan
- ▶ Hire purchase
- ▶ Lease purchase
- ▶ Finance lease
- ▶ Contract hire

With all products, you can choose a fixed-cost maintenance plan designed to help you budget accurately.

No matter what Audi model you choose, your local Audi Centre can provide you with a personalised quote which could fit your budget and motoring needs.

Audi Finance is a trading name of Volkswagen Financial Services (UK) Limited. An offer of finance depends on certain conditions. Available to people over 18 in the UK only.

## Audi Insurance

We want you to start enjoying your new car from day one and thanks to Audi Insurance complimentary seven day cover, you can. Call free on 0800 316 7893 (lines are open Monday to Friday 8am - 9pm, and Saturday 9am - 5pm), provide a few details and a cover note will be sent to your Audi Centre. They will then tax your car and you can drive it away.

Audi Insurance is a trading name of Volkswagen Insurance Service (Great Britain) Limited, an appointed representative of Volkswagen Financial Services (UK) Limited, Brunswick Court, Yeomans Drive, Blakelands, Milton Keynes MK14 5LR. Registered in England number 2835230. Audi Insurance is sold, underwritten and administered by Allianz Insurance plc registered in England number 84638. Registered office 57 Ladymead, Guildford, Surrey GU1 1DB. Volkswagen Financial Services (UK) Limited and Allianz Insurance plc are authorised and regulated by the Financial Services Authority. Volkswagen Financial Services (UK) Limited and Allianz Insurance plc are not part of the same corporate group.









**Audi UK**

Customer Services  
Selectapost 29  
Sheffield  
S97 3FG  
0800 699888  
audi.co.uk

Specifications and prices subject  
to change without notice.

© Audi UK

Printed in the UK  
Edition 0.1 09/12  
2013 model year

Images are for illustrative purposes only.

