



The Audi RS 5 Cabriolet
Pricing and Specification Guide
Valid from January 2013

Personalising your Audi RS 5 Cabriolet

This guide has been designed to help you tailor and price your Audi RS 5 Cabriolet quickly and logically. At the back, you will find information on CO2 emissions-based taxation and the other services offered by Audi, including Finance and Insurance. You can also configure your Audi RS 5 Cabriolet online at audi.co.uk.

You might also like to consider Audi Complete: a simple way to take care of servicing and maintenance costs for your Audi in a single package. You pay a one-off or monthly fee and we'll cover all your servicing, maintenance and tyres for the next three years including your first MOT. It means you only have to pay for fuel, insurance and your Road Fund Licence. So you can be reassured that your car will be maintained by trained Audi Technicians, using genuine Audi parts.

Audi Complete™

The Audi RS 5 Cabriolet

Engine	12
Transmission	13
Technology	14

Model details and prices

Standard model equipment	18
Model prices	20

Audi exclusive

22

Colour and upholstery

Paint and hoods	24
Upholstery	28
Colour and trim guide	31
Inlays	34

Options

Wheels and tyres	38
Performance	41
Packages	42
Audio and communication	44
Interior equipment	45
Seats	46
Exterior equipment	47
Safety and security	48
Steering wheels and controls packs	49
Audi Complete and warranty	50
Merchandise	51

Technical details

Technical data	52
Dimensions	53
Additional information	54
Pricing information	56





Vorsprung durch Technik

Three words that express the very essence of Audi. Vorsprung durch Technik isn't a slogan. It's our way of seeing the world. It is the driving force behind our history of innovation that continues into the 21st century. Indeed, many technologies that Audi pioneered remain in our cars today. Some are milestones in the history of the motorcar.

From our beginnings in 1899, to the Auto Union team's Grand Prix successes in the 1930s and our more recent wins at Le Mans, we have always been at the forefront of the motor industry.

Vorsprung durch Technik makes us who we are. To see more of its influence, just read on.





Introducing the RS 5 Cabriolet

The RS story has unfolded over the last fifteen years, delivering a series of elegant yet supremely powerful models – and the RS 5 Cabriolet is no exception. As a direct descendant of our most exciting high-performance models, it's the culmination of the technical expertise we've gained on roads and racetracks all over the world. Our long history of motorsport success is evident throughout the RS 5 Cabriolet. Some of the world's toughest races have taught us how to propel our cars ever more powerfully, responsively and efficiently. The RS 5 Cabriolet's engine epitomises this knowledge. A close relative of the V10 in the Audi R8, the 4.2 V8 FSI® engine develops 450PS and transmits a maximum of 430 Nm of torque. However, you'll see as you read on, there's much more to the RS 5 Cabriolet than thrilling power and handling – but we think you'll agree that these qualities are an excellent place to start.









RS 5 Cabriolet interior story

We've introduced a number of finishing touches to the Audi RS 5 Cabriolet interior to make your driving experience both comfortable and unique. You'll find an impressive attention to detail in everything from the luxurious leather seating to our optional customised stitching, which means that every journey you make will be a personal one.

Our Fine Nappa leather upholstery contains special colour pigmentation which prevents an intense build-up of heat, reflecting the sun's infrared radiation and helping to reduce surface temperature by up to 20°C .

Engine

Petrol

A 4.2-litre V8 FSI® engine is one innovation that sets the RS 5 Cabriolet apart – and keeps it there. That's thanks to our Le Mans-winning fuel-injection technology, which provides enhancements to fuel efficiency, power and torque. But this unit is capable of more than just delivering raw power; it's also adept at using it. Launch control combines both braking and acceleration to give you the quickest possible start, taking the RS 5 Cabriolet from 0 to 62mph in just 4.9 seconds. And once you accelerate, the engine provides consistent power build-up and superb responsiveness across the entire rev range. So when you need that bit more power, whatever the situation, you can be confident it will deliver. The impressive acoustics of the exhaust system with sound flap produce an unadulterated V8 sound – while there's also the option of a sports exhaust system with black tailpipe trims and even more distinctive acoustics.



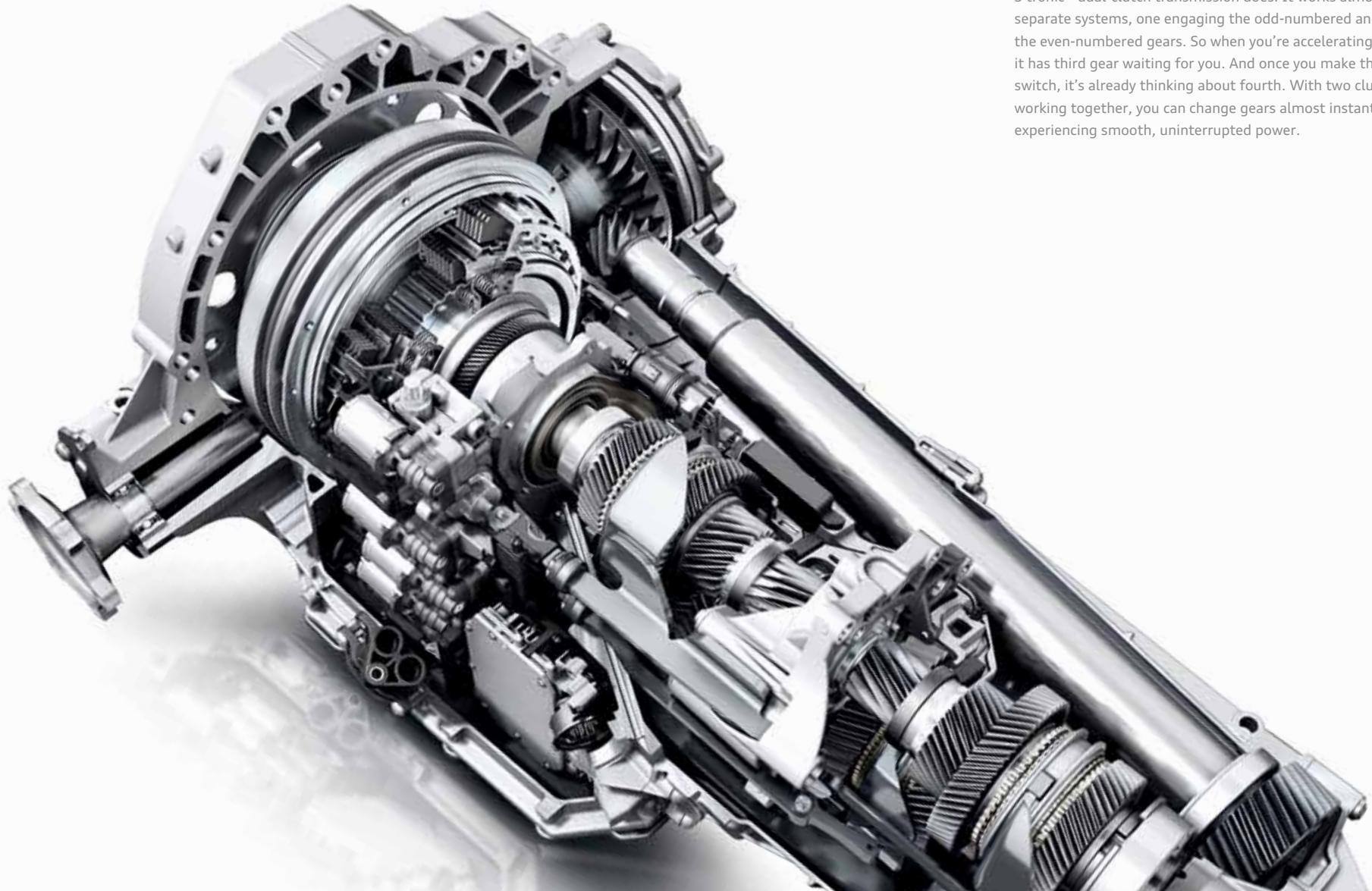

Transmission

S tronic®

Driving is all about thinking ahead, which is just what the S tronic® dual-clutch transmission does. It works almost as two separate systems, one engaging the odd-numbered and the other the even-numbered gears. So when you're accelerating in second, it has third gear waiting for you. And once you make the switch, it's already thinking about fourth. With two clutches working together, you can change gears almost instantly while experiencing smooth, uninterrupted power.

Technology

quattro® with Sports differential

The Audi RS 5 Cabriolet features the very latest generation of quattro® permanent all-wheel-drive – the exclusive road-holding technology that’s helped Audi dominate the racetrack ever since 1980. Two decades and many evolutions later, it’s 2.5kg lighter, more compact and now features the brand new crown-gear centre differential – an addition which achieves high locking values for even greater traction. A torque vectoring function also distributes different amounts of driving force to each wheel as necessary. The result: firm traction, precision handling and high lateral stability – no matter what the road conditions.





High-performance braking system

A car as powerful as the RS 5 Cabriolet needs an equally powerful system to slow it down. The high-performance braking system has black, high-gloss 8-piston fixed callipers in the front wheels and single-piston sliding callipers in the rear. The brake discs are internally ventilated, and perforated for enhanced performance. And for even more impressive braking power, there's the option of 19-inch ceramic brakes.





Standard model equipment

All RS 5 Cabriolet models have the following items of standard equipment

The equipment for the Audi RS 5 Cabriolet builds upon the standard equipment for the Audi S5 Cabriolet. The typical characteristics of the Audi RS models emphasise the exclusive, dynamic and sporty character of the Audi RS 5 Cabriolet. It is unmistakable.

Wheels, tyres and suspension
19" x 9J '10-spoke' design alloy wheels with 265/35 R19 tyres and locking wheel bolts

Audi drive select changes your car's handling and responses at the touch of a button to suit the way you want to drive. Enables the driver to alter the throttle response, the shift point of the automatic transmission, exhaust flap control and the power steering feel between the three pre-set modes: comfort, dynamic and auto or individual mode

RS high-performance braking system with brake callipers painted in highly polished black, and RS logo at the front
quattro® permanent all-wheel-drive with Sports differential – the electronically regulated Sports differential distributes variable amounts of driving force to each rear wheel, ensuring outstanding acceleration performance in corners and stabilising the vehicle's response to load change. It also ensures better direct steering characteristics and, thanks to less steering effort, more agile handling
Tyre Mobility System

Electromechanical power steering
RS 5 Sports suspension

Safety and security

Audi parking system plus, acoustic and visual parking assist system for the front and rear

Rest recommendation system – analyses driving behaviour based on steering, pedals and gear lever movements. If the system detects a change in driving patterns it can, via audio and visual effects, notify the driver of the possible need to take a break

Electromechanical parking brake – includes parking brake function when stationary, drive-off assistance function through automatic release when driving away and emergency braking function whilst driving, acting on all 4 wheels

Electronic Stability Programme (ESP)

First-aid kit

Front airbags

Front and rear ISOFIX child seat preparation with front passenger airbag deactivation switch

Front side airbags

Light and rain sensor – automatically switches the dipped beam headlights and windscreen wipers on/off depending on the light and rain conditions. Also includes coming home/leaving home function which delays the deactivation of the front and rear lights after locking and automatically activates the lights when unlocking

Rear fog lights

Thatcham category 1 alarm

Toolkit and car jack

Tyre pressure monitoring system

Warning triangle

Seats

Electric lumbar support for front seats

RS Super Sports seats, electrically adjustable

Fine Nappa leather with heat protection, contrasting piping and RS embossing

Leather armrests including leather covered armrest on door panel



RS multi-function steering wheel



19" x 9J '10-spoke' design alloy wheels



RS Super Sports seats



Carbon inlays

Audio and communication

Audi Sound System speaker package, with 10 speakers including subwoofer (180 Watts)

HDD-based Satellite Navigation with 3rd Generation MMI. Hard disk navigation with topographical map displays places of interest and town models in 3D, with high-resolution 7" colour TFT display. The system offers three alternative routes, with the ability to scroll along the selected route and manoeuvre within the map. Uses 7-digit postcode recognition. Includes split-screen mode for route information, dynamic route guidance (TMC), intersection zoom function, motorway exits and lane recommendations in Driver's Information System (DIS)

When combined with mobile telephone preparation – High with Audi connect (9ZW), the system uses Google Earth images for navigation

Includes 2 SD card readers, single CD/DVD player and 40GB hard drive, Jukebox (20GB) for storing and managing music files in WMA and MP3 format.

Includes European navigation data (where digitalised)

Audi Music Interface – provides connection for use with stereo audio sources, USB and MP3 devices including Apple iPod generation 4 onwards and Apple iPhone. Provides intuitive control through the audio system and multi-function steering wheel. It also replicates the iPod display on the audio screen and DIS, including track titles. The interface provides a charging function (dependent on device). Includes 2 cables to connect your iPod or USB MP3 device

Mobile phone preparation – Bluetooth interface

Interior equipment

Carbon inlays

Cruise control – maintains any speed above 18mph, provided the engine power output and engine braking effect permit it; operated via separate steering column stalk. The set speed is displayed in the Driver's Information System

Deluxe 3-zone climate control with separate air distribution and digital display for the driver and front passenger. System includes air-conditioning controls

in the rear centre console for passenger compartment

Auto-dimming rear view mirror

Wind deflector

Driver's Information System (DIS) in colour with energy-saving tips. Shows the radio station or track title, telephone control, menu and other display information from the infotainment system, such as navigation. Also includes an on-board trip computer with short and long-term trip memory, outside temperature display, digital speedometer and door or boot open warning

Front centre armrest including 12V power socket

Interior light package. Includes front and rear footwell lighting, active door reflectors, illuminated vanity mirrors, rear reading lights, entrance lights and illuminated glove compartment, vents and internal door controls

RS instrument panel

RS 3-spoke flat-bottomed steering wheel with aluminium-look shift paddles and RS 5 emblem; covered in perforated leather with contrasting stitching in rock grey

Through-load facility located in the backrest of the centre rear seat, providing practical and safe transport of long objects. Includes ski/snowboard bag for up to 4 pairs of skis or 2 snowboards up to 200cm in length

Exterior equipment

Fully automatic hood (can be operated at speeds up to 31mph)

Audi single-frame grille. Honeycomb structure in high-gloss anthracite with matt-finish aluminium-look frame

Adaptive light including Xenon headlights, LED daytime-running lights, LED rear lights, headlight washer system and automatic range adjust

Exterior mirrors – electrically operated and heated

Matt-finished aluminium-look door mirror housings, windscreen frame and grille

RS body styling including front bumper with enlarged air inlets, rear diffuser and flared wheel arches

Fixed rear spoiler, finished in carbon

Two oval exhaust pipes



Fixed rear spoiler, finished in carbon



Oval exhaust with optional matt aluminium styling package



Honeycomb structure in high-gloss anthracite with matt-finish aluminium-look frame



LED rear lights

RS 5 Cabriolet

Engine	Power	Transmission	CO ₂ g/km	Basic RRP	Total RRP inc VAT	Recommended OTR
4.2 FSI quattro	450PS	7-speed S tronic	249	£56,250.00	£67,500.00	£68,960.00

Please note: The maximum power output figures are quoted in PS (or Pferdestärke, which is the metric equivalent of brake horsepower). To convert to brake horsepower, divide the PS figure by 1.0139.

Recommended On-The-Road (OTR) retail prices include: delivery charge, half a tank of fuel, number plates at £590.00 (inc. VAT), Road Fund Licence (which may vary depending on model/transmission see page 54 for details) and first registration fee at £55.00. Vehicle Excise Duty correct at time of going to print, but this may alter to reflect any change in the applicable VED rate.

RRP – Recommended Retail Price. VAT is calculated at 20% but this may alter to reflect any change in the applicable VAT rate.







Audi exclusive

Every Audi is intrinsically exclusive. It's the breathtaking design, the exceptional engineering, the Vorsprung durch Technik. But for that special touch you can specify your Audi RS 5 Cabriolet with options from Audi exclusive. Whether you want a unique, custom-mixed paint colour or seats in a combination of complementary shades, Audi exclusive will enable you to drive the car you've always imagined.

Both the exclusive and standard options can be found on the following pages.



Paint choices

We believe that every part of your car should have a personal touch. Which is why you can choose from a wide range of paint colours and finishes, from standard shades to metallic and pearl effects. We can even mix a customised colour for you to create the perfect fit.

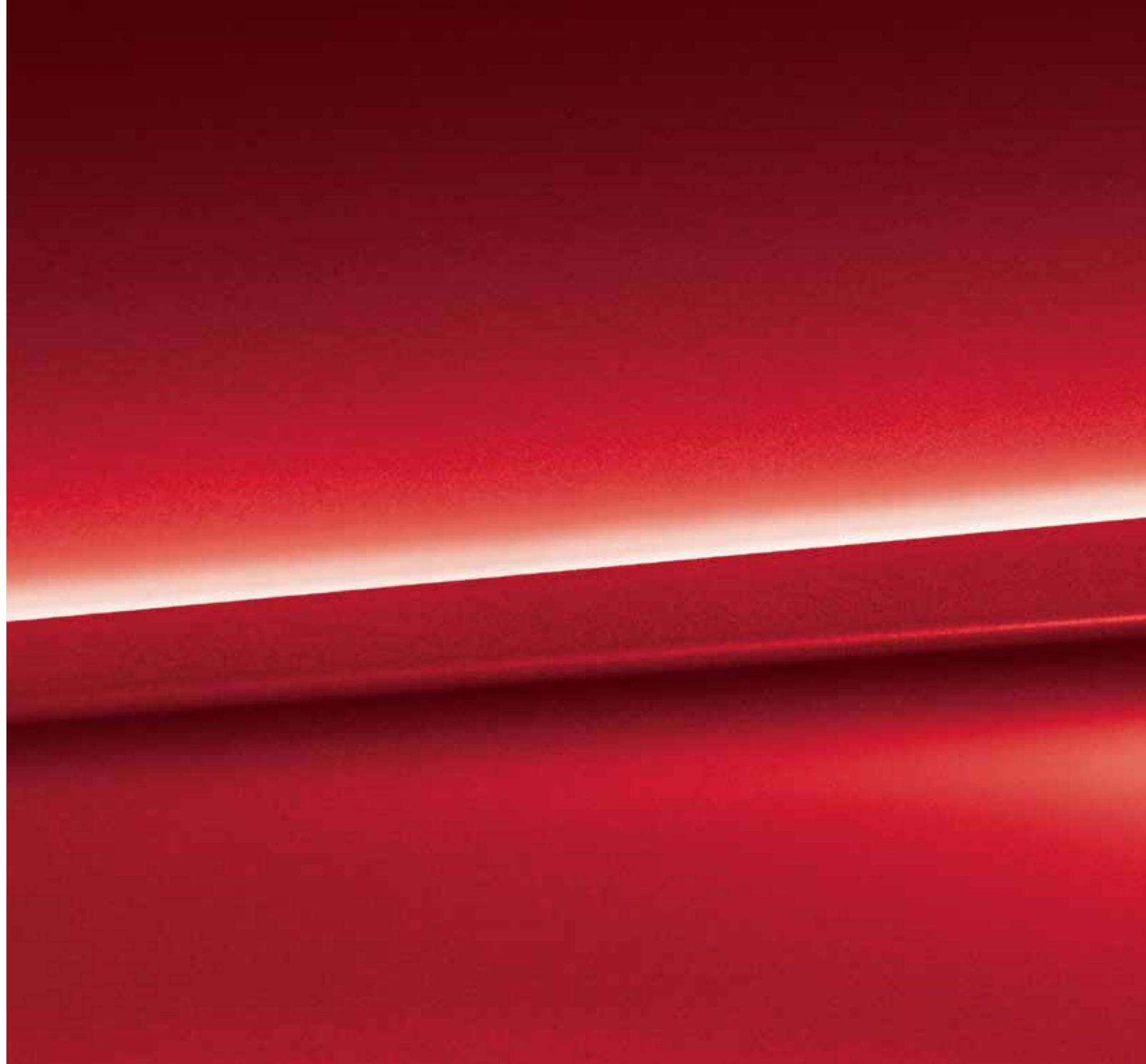

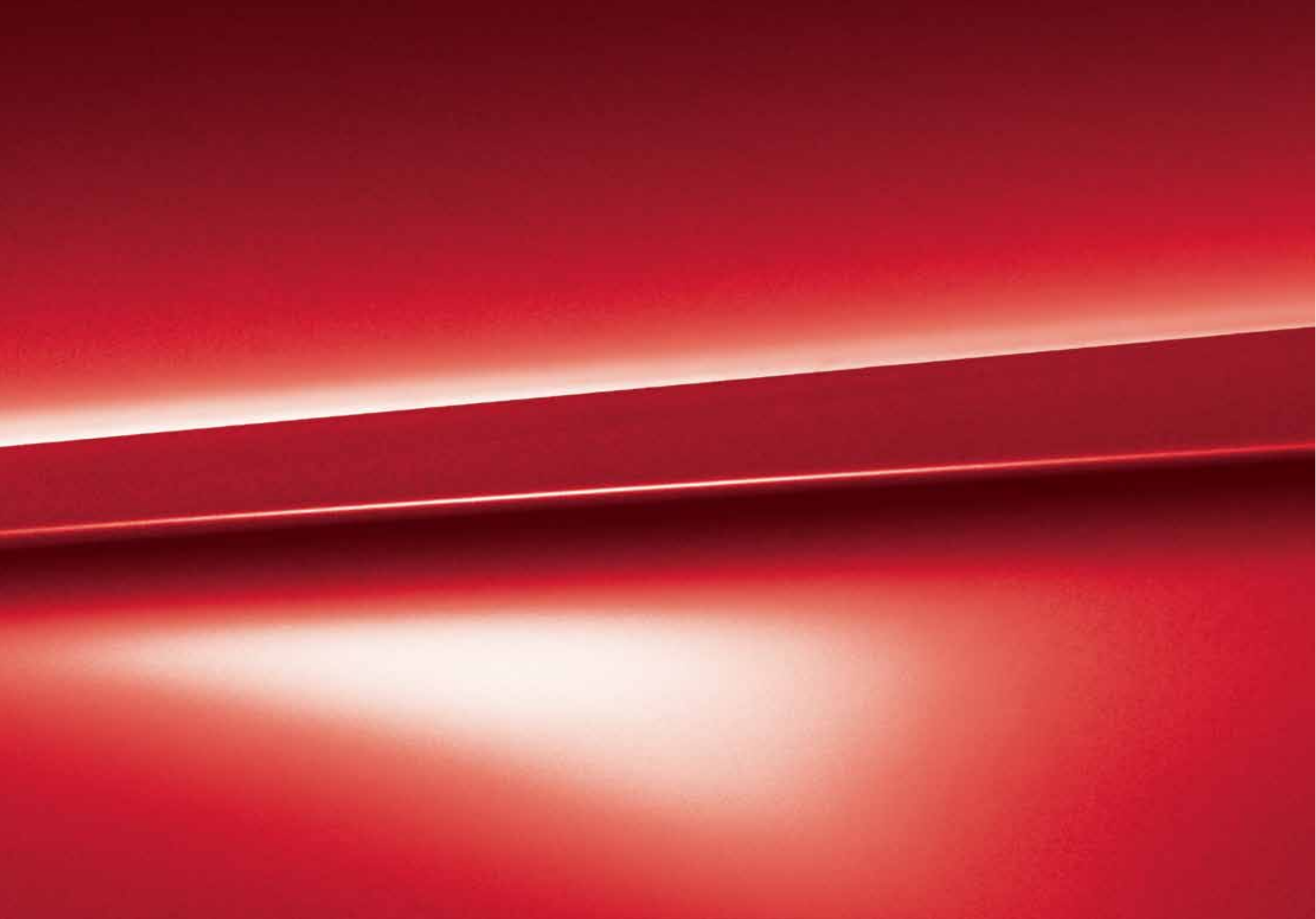

Paint

You can select the standard Ibis white shown opposite or, for a different look, choose from the range of optional finishes.

Standard colour



Ibis white – T9

Optional colours

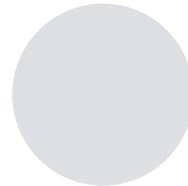

Suzuka grey, metallic – M1

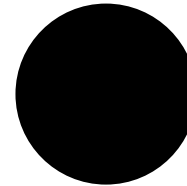

Phantom black, pearl effect – L8

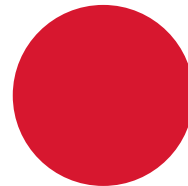

Misano red, pearl effect – N9

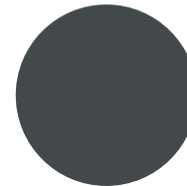

Daytona grey, pearl effect – 6Y

Crystal effect

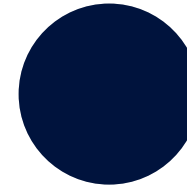

Estoril blue, crystal effect – K0

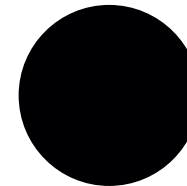

Panther black, crystal effect – H8



Prism silver, crystal effect – T0

Options are subject to availability and may extend delivery.

All the colour swatches on this page are matched as accurately as possible to the actual paint colours used. However, due to print processes, Audi UK cannot guarantee that colours shown are 100% accurate.

Visit your local Audi Centre for a more accurate colour swatch.

RRP – Recommended Retail Price.

VAT is calculated at 20% but this may alter to reflect any change in the applicable VAT rate.

Optional colours

Basic RRP
£512.50

Total RRP inc VAT
£615.00

Crystal effect

Basic RRP
£720.83

Total RRP inc VAT
£865.00

Hood colours



Red - SF

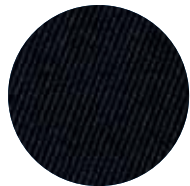

Black - PA

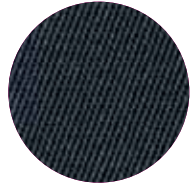

Dark grey - SW



Brown - PW

Paint

Audi exclusive

Everyone has a favourite colour. No matter what yours is, Audi exclusive provides a range of unique colours that have been designed to set your car apart. Choose from the swatches here, or specify any other paint colour in the Audi range - whether it's Jet blue from the Audi R8 or Alpine white from the original Audi quattro. The choice is yours.

Customised

If you have a particular colour in mind, we'll mix the exact metallic or pearl-effect shade you want.*

Options are subject to availability and may extend delivery.

*Custom paint is subject to factory approval, and is available for metallic and pearl-effect water-based paints only. Three-colour process colours and two-tone schemes are not available.

**Visit your local Audi Centre for colour samples.

All the colour swatches on this page are matched as accurately as possible to the actual paint colours used. However, due to print processes, Audi UK cannot guarantee that colours shown are 100% accurate.

RRP - Recommended Retail Price.

VAT is calculated at 20% but this may alter to reflect any change in the applicable VAT rate.

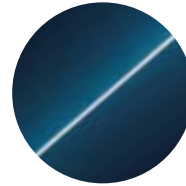

Palace blue, pearl effect

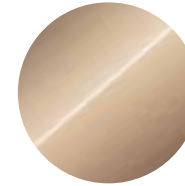

Sand beige, pearl effect

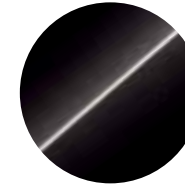

Saddle brown, pearl effect

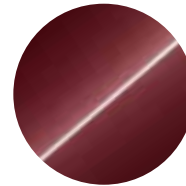

Classic red, pearl effect

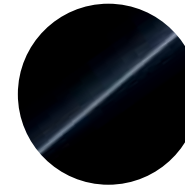

Mamba black, metallic

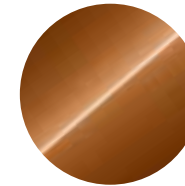

Ipanema brown, metallic



Any colour in the Audi range



100 Audi exclusive colours to choose from**

Audi exclusive

Basic RRP
£1,762.50

Total RRP inc VAT
£2,115.00



Customised paint

Customised

Basic RRP
£2,179.17

Total RRP inc VAT
£2,615.00

Upholstery

It's important to feel comfortable on the road. Just choose from our range of luxury upholstery materials and textures, including additional support and colour options, for complete relaxation while you drive.





Upholstery

RS embossed front Super Sports seats

Choose your favourite upholstery from the swatches shown opposite to give your car's interior the look and feel you want.

You can also order front bucket seats – please see page 46 for details.

Fine Nappa leather

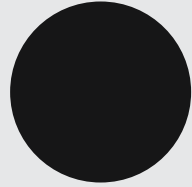

Black with Rock grey piping – **UB/UD**



Lunar silver with Rock grey piping – **QO/UI**

Leather/Alcantara



Black – **QH/SC**

RS 5	Basic RRP	Total RRP inc VAT
S	No charge	No charge
●	No charge	No charge

Options are subject to availability and may extend delivery.

- = Not available
- = Available
- S = Standard

RRP – Recommended Retail Price.

VAT is calculated at 20% but this may alter to reflect any change in the applicable VAT rate.

Colour and trim guide

Interior trim colours

RS embossed front Super Sports seats

To help you choose the right interior for your Audi RS 5 Cabriolet, please use this guide which shows the carpet, dashboard and headlining colours that have been matched to your chosen upholstery.

RS embossed front bucket seats* (PS5)

Order code	Upholstery	Carpet	Dashboard (upper/lower)	Headlining	Fine Nappa leather (N5V)	Leather/Alcantara (N7S)
UB/UD	Black with Rock grey piping	Black	Black	Black/Silver	●	—
QO/UI	Lunar silver with Rock grey piping	Black	Black	Black/Silver	●	—
QH/SC	Black	Black	Black	Black/Silver	—	●

Order code	Upholstery	Carpet	Dashboard (upper/lower)	Headlining	Fine Nappa leather (N1T)
QH/SC	Black metallic with Rock grey stitching	Black	Black	Black/Silver	●

Options are subject to availability and may extend delivery.

- = Not available
- = Available
- S = Standard

*Must be ordered in conjunction with heated front seats (4A3) or heated front and rear seats (4A4).



Front Super Sports seats



Front bucket seats (PS5)

Upholstery

Audi exclusive

With Audi exclusive, you can specify your seats in Valcona leather or Valcona leather/Alcantara, in an array of different colours shown to the right.

Select just one all-over shade for each seat, or customise each panel in two or more complementary colours from the distinctive Audi exclusive palette. You can even choose the colour of the decorative stitching – to match or contrast with your chosen upholstery – from this varied collection. Whatever combination you decide upon, we think you'll be extremely comfortable with the result.

Options are subject to availability and may extend delivery.

– = Not available
• = Available
S = Standard

*Leather and stitching (where applicable) can be specified in a variety of colours from the Audi exclusive range.

RRP – Recommended Retail Price.

VAT is calculated at 20% but this may alter to reflect any change in the applicable VAT rate.

Order Code		RS 5	Basic RRP	Total RRP inc VAT
PYO S3G	Audi exclusive design package: RS 5 bucket seats in Black quilted Valcona leather with diamond design and red stitching. Seat upholstery, head restraints, door trim inserts, front centre armrest and door armrests in black Valcona leather with RS 5 logo embossed in the front seat backrests. Crimson red stitching to door armrests and controls, and includes black floor mats with Crimson red leather piping	•	£5,783.33	£6,940.00
PYI S3G	Audi exclusive design package: RS 5 bucket seats with Audi exclusive quilted Valcona leather with diamond design. Seat upholstery, head restraints, door trim inserts, front centre armrest and door armrests in Valcona leather with RS 5 logo embossed in the seatbacks of the front seats. Includes stitching to door armrests and controls*	•	£5,783.33	£6,940.00



Chestnut brown



Jet grey



Alabaster white

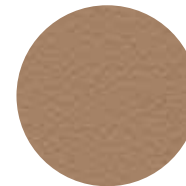

Sand beige

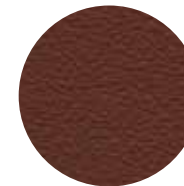

Saddle brown



Crimson red



Magnolia white



Havanna brown



Cognac brown



Night blue

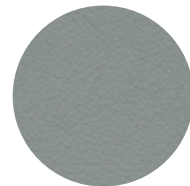

Cloudy grey

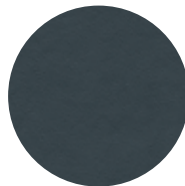

Smoky blue

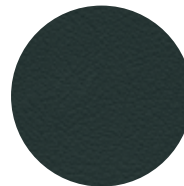

Iceland green



Powder beige



Classic red

Also available:

Alcantara colours: available in all the Audi exclusive colours shown, except for Crimson red, Jet grey and Sand beige. Alcantara equivalents are Chilli red, Amethyst grey, and Sesame beige respectively.

Carpet colours: available in all the Audi exclusive colours shown.

Please consult your Audi Centre for examples of Alcantara and carpet colours.



Inlays

Attention to detail can make a big impact. From contemporary Piano finish, black to Stainless steel mesh, our selection of inlays make the perfect finishing touch to your car's interior.





Inlays

Inlays are the all-important finishing touch that add flair and interest to your car's interior.

Order Code		RS 5	Basic RRP	Total RRP inc VAT
5MB	Carbon	S	No charge	No charge
5TG	Matt-brushed aluminium	●	No charge	No charge
5TL	Piano finish, black	●	No charge	No charge
5MD	Aluminium race design	●	No charge	No charge
5MZ	Stainless steel mesh (centre console in Piano finish, black)	●	No charge	No charge

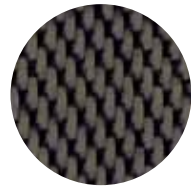

Carbon – **5MB**

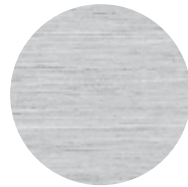

Matt-brushed aluminium – **5TG**

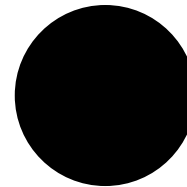

Piano finish, black – **5TL**

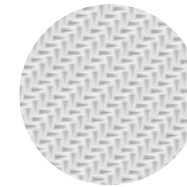

Aluminium race design – **5MD**



Stainless steel mesh – **5MZ**
(centre console in Piano finish, black)

Options are subject to availability and may extend delivery.

- = Not available
- = Available
- S = Standard

RRP – Recommended Retail Price.

VAT is calculated at 20% but this may alter to reflect any change in the applicable VAT rate.

Inlays

Audi exclusive

Audi exclusive has sourced a varied range of materials from which to craft these elements. You can even customise your gear knob and steering wheel with one of the available woods, all of which are shown opposite.

Order Code		RS 5	Basic RRP	Total RRP inc VAT
YTA S3G	Audi exclusive inlays (cannot be combined with the inlays shown on page 36)	●	£675.00	£810.00
YTF S3G	Audi exclusive body colour inlays	●	£1,125.00	£1,350.00



Fine grain ash, nougat



Fine grain myrtle, nutmeg



Oak, sepia



Audi exclusive inlays in body colour - YTF/S3G

Options are subject to availability and may extend delivery.

- = Not available
- = Available
- S = Standard

RRP - Recommended Retail Price.

VAT is calculated at 20% but this may alter to reflect any change in the applicable VAT rate.

Options

Every driver has different needs, which is why we have created some useful options to further enhance your car. For extra comfort, support, style or function, you can choose from a variety of additional features, tailoring everything from your infotainment and audio equipment to your wheels and lighting.



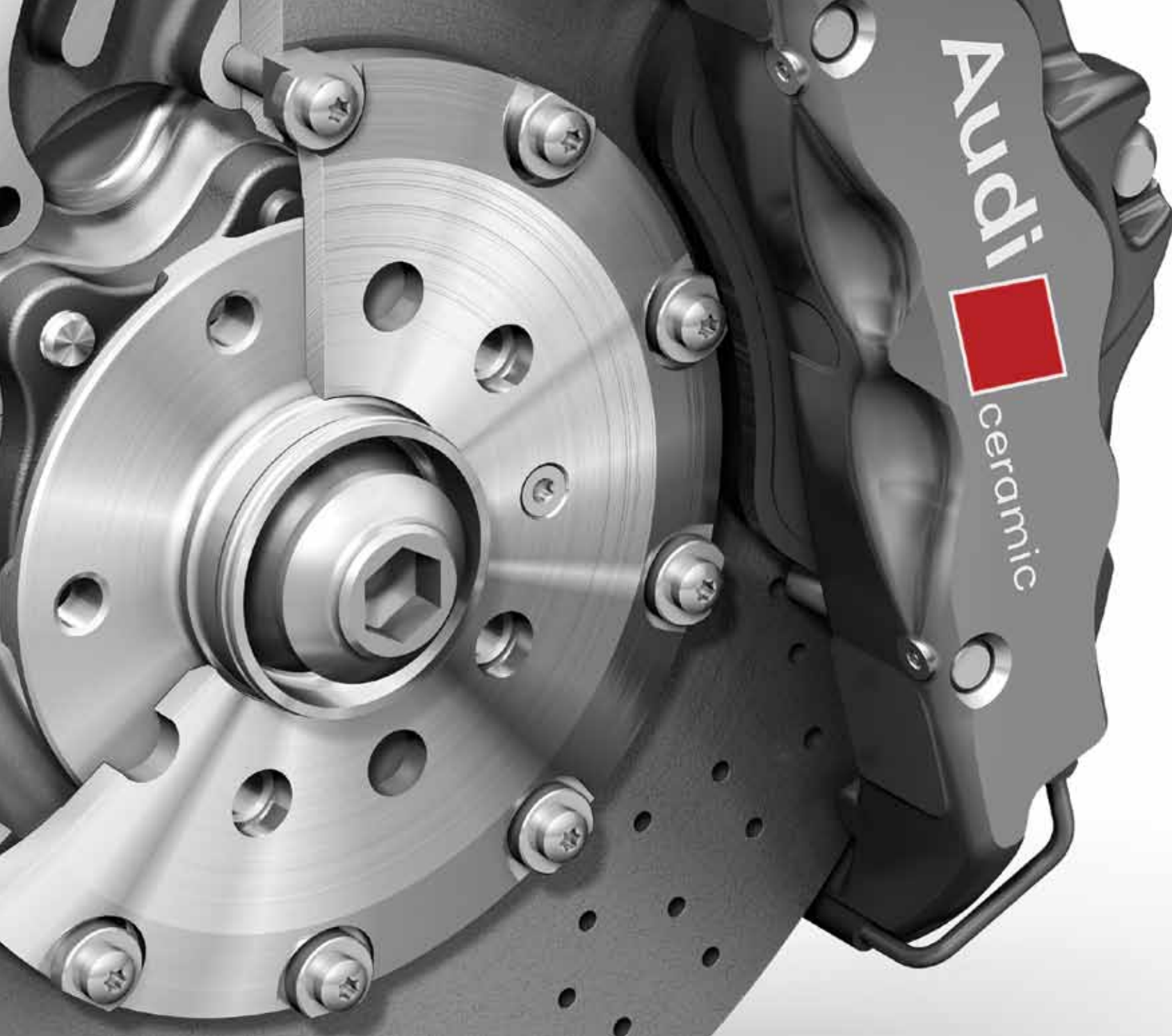

Wheels and tyres

Choose a set of specially-selected alloy wheels to subtly enhance the way your car looks and drives.

Order Code		RS 5	Basic RRP	Total RRP inc VAT
C5H	19" x 9J '10-spoke' design alloy wheels with 265/35 R19 tyres	S	No charge	No charge
PQW	20" x 9J '5-arm Rotor' design alloy wheels with 275/30 R20 tyres	•	£1,041.67	£1,250.00
PQI	20" x 9J '5 V spoke' design titanium-look alloy wheels with 275/30 R20 tyres	•	£1,125.00	£1,350.00
PQU	20" x 9J '5-arm Rotor' design titanium-look alloy wheels with 275/30 R20 tyres	•	£1,125.00	£1,350.00
1N8	Dynamic steering. With this new technology, driving is significantly more agile under everyday conditions, while directional stability and precision are increased at high speeds and in demanding driving conditions	•	£312.50	£375.00



19" x 9J '10-spoke' design alloy wheels – C5H



20" x 9J '5 V spoke' design titanium-look alloy wheels – PQI



20" x 9J '5-arm Rotor' design alloy wheels – PQW



20" x 9J '5-arm Rotor' design titanium-look alloy wheels – PQU

Options are subject to availability and may extend delivery.

- = Not available
- = Available
- S = Standard

RRP – Recommended Retail Price.

VAT is calculated at 20% but this may alter to reflect any change in the applicable VAT rate.

Performance

We've developed a whole range of performance options to complement the capabilities of the RS 5 Cabriolet – everything from an increased top speed to a high-performance brake system.

Options are subject to availability and may extend delivery.

*Where law permits.

- = Not available
- = Available
- S = Standard

RRP – Recommended Retail Price.

VAT is calculated at 20% but this may alter to reflect any change in the applicable VAT rate.

Order Code		RS 5	Basic RRP	Total RRP inc VAT
NM5	Carbon design package for engine bay	•	£366.67	£440.00
1LW	Ceramic brakes – front. High-performance brake system with carbon-fibre reinforced, vented and perforated ceramic brake discs. Brake callipers in Anthracite with 'Audi ceramic' logo on front	•	£4,375.00	£5,250.00
OP6	Sports exhaust. Oval-shaped dual-exhaust pipes in matt black which subtly alter the sound of the RS 5 engine	•	£741.67	£890.00
6Y9	Top speed restrictor increase to 174mph*	•	£1,083.33	£1,300.00
2MC	Dynamic ride control. Enhanced suspension setup which consists of a special shock absorber system that counteracts pitch and body roll movements without using any electronic devices. With DRC, diagonally opposed shock absorbers on the car are linked together hydraulically. A central valve varies the shock absorber operating characteristic, for instance when the steering wheel is turned and the car is cornered, so that movement around the longitudinal axis (roll) is significantly reduced. DRC uses the same principle to counteract body movement around the transverse axis (pitch) when the car is accelerated or braked. There is a choice of 3 settings: comfort, dynamic or auto. Also available as part of the Sports package (WC9)	•	£1,425.00	£1,710.00



Sports exhaust. Oval shaped dual exhaust pipes in matt black



Carbon design package for engine bay



Ceramic brakes – front

Packages

Some items work well together, which is why we've created these special packages. They provide increased convenience and value by combining several of our most popular options.

Options are subject to availability and may extend delivery.

- = Not available
- = Available
- S = Standard

RRP – Recommended Retail Price.

VAT is calculated at 20% but this may alter to reflect any change in the applicable VAT rate.

Order Code		RS 5	Basic RRP	Total RRP inc VAT
WC9	Sports package. 20" x 9J '5-arm Rotor' design titanium-look alloy wheels, dynamic ride control, dynamic steering and Sports exhaust	•	£1,875.00	£2,250.00
WB3 QV3	Sound package. Featuring Bang & Olufsen sound system and DAB digital radio. Bang & Olufsen sound system. Designed specifically for the Audi RS 5 Cabriolet, featuring 14 high-performance speakers and two amplifiers which create 505 Watts of stunning 5.1 surround sound, balanced to suit the specific acoustic properties of the car's interior. The system constantly and automatically adapts the sound characteristics to the vehicle's speed, background noise and whether the roof is open or closed, to provide the highest level quality. DAB digital radio. Receives programmes from digital radio transmitters, in addition to the range of analogue stations, with better sound quality	•	£500.00	£600.00
PCB	Driver assistance package includes adaptive cruise control, Audi parking system advanced and Audi active lane assist. Adaptive cruise control with braking guard. Intelligent automatic speed and distance control system. Works at speeds from 19-155mph, using radar sensors to measure and maintain required distance to vehicle ahead by braking and accelerating. Four programs (distance 1 to distance 4) set via steering column controls of the cruise control system. Includes Audi braking guard – a system which triggers a visual and acoustic alarm when it detects the risk of a rear end collision with the vehicle in front. At speeds below 19mph the system can initiate partial braking or full deceleration to help prevent a collision if a potential impact is detected or if it is not possible to completely prevent a collision, the system will focus on reducing the speed at which the vehicles collide Audi parking system advanced. Aids parking by acoustically and visually indicating distances to obstacles with guiding lines. Measured by sensors and reversing camera Audi active lane assist. Helps the driver to stay in lane with gentle steering impulses for greater safety and convenience, particularly on motorways and country roads. The system informs the driver if the car is drifting out of its lane unintentionally	•	£791.67	£950.00



20" x 9J '5-arm Rotor' design titanium-look alloy wheels



Bang & Olufsen sound system



Audio and communication

Stay in touch using our range of communication functions, and give each journey its own soundtrack with our advanced audio equipment.

Options are subject to availability and may extend delivery.

- = Not available
● = Available
S = Standard

¹To check the compatibility of your mobile phone and whether it has SIM Access Profile compatibility, please visit www.audi.co.uk/owners-area/phone-compatibility.html

²Please note that when a data SIM card is inserted into the SIM card reader, Bluetooth handsfree connectivity is disabled as the SIM card takes priority over the Bluetooth connection.

³Online services are only available for mobile phone contracts including a data option and only within the coverage of the mobile phone network; there may be additional costs for the use of these services (charges and billing correspond to the personal mobile phone contract). Due to high data volumes, a mobile phone contract including an unlimited data plan is strongly recommended. The content and scope of the online-based services offered may vary.

RRP – Recommended Retail Price.

VAT is calculated at 20% but this may alter to reflect any change in the applicable VAT rate.

Order Code		RS 5	Basic RRP	Total RRP inc VAT
QV3	DAB digital radio	●	£254.17	£305.00
9VK	Bang & Olufsen sound system. Designed specifically for the Audi RS 5 Cabriolet, featuring 14 high-performance speakers and two amplifiers which create 505 Watts of stunning 5.1 surround sound, balanced to suit the specific acoustic properties of the car's interior. The system constantly and automatically adapts the sound characteristics to the vehicle's speed, background noise and whether the roof is open or closed, to provide the highest level of quality.	●	£445.83	£535.00
9ZF	Mobile telephone preparation – Low. Uses Bluetooth interface or cradle to connect to your RS 5, using the car's own GSM antennae for optimal reception and charger. A phone adaptor is required at extra cost – please consult your Audi Centre for phone compatibility	●	£145.83	£175.00
9ZW	Mobile telephone preparation – High with Audi connect. A mobile phone can be connected to the internal UMTS (3G) module via Bluetooth (provided the mobile telephone has SIM Access Profile ¹), or alternatively through the additional SIM card reader ² . It is possible to transfer phone book entries to the car and manage call lists. Audi connect features include: navigation using Google Earth images and Google Street View, destination entry via Google Maps or myAudi, online point of interest search and information services such as weather forecasts and the latest world news. Audi connect also includes Audi traffic information online, which gives accurate real-time forecasts of the traffic situation along the chosen route. The traffic situation can be displayed on the navigation map or Google Earth image. Audi connect can also create a Wi-Fi hotspot in the car for convenient internet access using a mobile device (e.g. laptop or tablet) ³ . Many Audi connect features can be simply operated via MMI Navigation Plus or the multi-function steering wheel	●	£291.67	£350.00
7D1	CD changer	●	£254.17	£305.00
QU7	Digital TV reception. Reception of digital (DVB-T) uncoded television stations (MPEG-2 standard), TV picture, teletext and Electronic Programme Guide (EPG). Facility to connect 2 external AV sources via adaptor cables (available from Audi Genuine Accessories). TV reception depends on local digital network availability. No AV or TV video output when driving (audio output available when driving)	●	£687.50	£825.00
QU6	Digital TV reception and DAB digital radio reception. Reception of digital (DVB-T) uncoded television stations (MPEG-2 standard), TV picture, teletext and Electronic Programme Guide (EPG). Facility to connect 2 external AV sources via adaptor cables (available from Audi Genuine Accessories). TV reception depends on local digital network availability. No AV or TV video output when driving (audio output available when driving)	●	£941.67	£1,130.00

Interior equipment

Specify every detail of your car's interior with this range of exclusive options.

Options are subject to availability and may extend delivery.

- = Not available
- = Available
- S = Standard

*HomeLink® is a registered trademark of Johnson Controls. For information on compatibility, visit www.homelink.com

RRP – Recommended Retail Price.

VAT is calculated at 20% but this may alter to reflect any change in the applicable VAT rate.

Order Code		RS 5	Basic RRP	Total RRP inc VAT
4F2	Advanced key. Access and authorisation system which automatically exchanges data between key and vehicle, allowing the driver to keep the key in their pocket or bag at all times. To unlock and open, simply lift the exterior door handle. To lock, press the button on the handle. Pressing the start/stop button integrated in the centre console starts and stops the engine	•	£391.67	£470.00
8T4	Adaptive cruise control with braking guard. Intelligent automatic speed and distance control system. Works at speeds from 19-155mph, using radar sensors to measure and maintain required distance to vehicle ahead by braking and accelerating. Four programs (distance 1 to distance 4) set via steering column controls of the cruise control system. Includes Audi braking guard – a system which triggers a visual and acoustic alarm when it detects the risk of a rear end collision with the vehicle in front. At speeds below 19mph the system can initiate partial braking or full deceleration if a potential impact is detected to help prevent a collision, or if it is not possible to completely prevent a collision, the system will focus on reducing the speed at which the vehicles collide	•	£750.00	£900.00
VC1	Garage door opener (HomeLink®). Programmable radio-operated remote control for compatible doors/gates. Control buttons integrated in the roof module at the front	•	£150.00	£180.00
YTZ S3G	Audi exclusive Black floor mats with RS 5 logo	•	£366.67	£440.00
YSR S3G	Audi exclusive floor mats with leather piping.** Includes 4 floor mats for front and rear (cannot be combined with option YSQ/S3G – Audi exclusive carpets or YTZ – Audi exclusive floor mats with RS 5 logo)	•	£366.67	£440.00
YSQ S3G	Audi exclusive carpets.** Includes 4 Audi exclusive floor mats with leather piping (cannot be combined with option YSR/S3G – Audi exclusive floor mats or YTZ – Audi exclusive floor mats with RS 5 logo)	•	£725.00	£870.00



**The leather, stitching, seat belts and leather piping (where applicable) can be selected from any of the Audi exclusive colours shown on page 32. The carpet colour can also be selected from any of the Audi exclusive colours shown on page 32.

Seats

Choose from a variety of different seat options so you can maintain the right driving posture at all times.

Order Code		RS 5	Basic RRP	Total RRP inc VAT
PV3 6XL	Convenience package. Comprising electric front seats with memory function on driver's side and lumbar support. Also includes acoustic windscreen and electrically folding and auto-dimming door mirrors with memory function and automatic kerb view function, which tilts the passenger mirror downwards towards the kerb when reverse gear is engaged (not in combination with RS bucket seats)	●	£375.00	£450.00
4A3	Heated front seats	●	£250.00	£300.00
4A4	Heated front and outer rear seats	●	£383.33	£460.00
	In combination with RS front bucket seats	●	£150.00	£180.00
PS5 4A3 N1T	RS embossed bucket seats in Fine Nappa leather. With more pronounced seat contours to give increased lateral support for sporty driving. Heated, with electric lumbar support and width adjustment for seat cushion and backrest. Manual forwards/backwards, seat height and backrest adjustment. This option deletes front side airbags, passenger airbag disconnect and ISOFIX preparation for front passenger seat. Not available in combination with storage package, electric front seats or through-load facility	●	£1,445.83	£1,735.00
YSZ S3G	Audi exclusive body-colour backrest covers for RS embossed bucket seats. Backrest covers of your front RS 5 embossed bucket seats painted to match your RS 5 Cabriolet's body colour	●	£1,666.67	£2,000.00

Options are subject to availability and may extend delivery.

- = Not available
- = Available
- S = Standard

RRP – Recommended Retail Price.

VAT is calculated at 20% but this may alter to reflect any change in the applicable VAT rate.

Exterior equipment

Make sure your car looks exactly as you want it to by selecting some of our striking options.

Order Code		RS 5	Basic RRP	Total RRP inc VAT
6XE	Door mirrors – electrically adjustable, heated and foldable. Includes automatic kerb function, which tilts the passenger mirror downwards towards the kerb when reverse gear is engaged	●	£150.00	£180.00
8N7	High-beam assist. Automatically adjusts headlights from high-beam to dipped-beam when another vehicle is approaching	●	£91.67	£110.00
VJ4	Matt aluminium styling package – front lip spoiler and bottom edge of rear diffuser in matt aluminium	●	£500.00	£600.00

Options are subject to availability and may extend delivery.

- = Not available
- = Available
- S = Standard

RRP – Recommended Retail Price.

VAT is calculated at 20% but this may alter to reflect any change in the applicable VAT rate.



Matt aluminium styling package – rear diffuser in matt aluminium



Matt aluminium styling package – front lip spoiler

Safety and security

Intelligent technology designed to give you better all-round awareness and safety on the road.

Order Code		RS 5	Basic RRP	Total RRP inc VAT
7X8	Audi parking system advanced. Aids parking by acoustically and visually indicating distances to obstacles with guiding lines. Measured by sensors and reversing camera	●	£283.33	£340.00
UH2	Audi hill-hold assist. Automatically activates electromechanical parking brake when stationary	●	£54.17	£65.00
7Y1	Audi side assist. Aids the driver when changing lane. Audi side assist monitors the area behind your car, using radar sensors located discreetly in the rear bumper, informing the driver with a visual warning signal in the door mirror if there is a vehicle in their blind spot or approaching quickly from behind. The system is activated using a button in the driver's door	●	£366.67	£440.00
7Y4	Audi active lane assist uses a discreet camera mounted at the top of the windscreen to monitor the road ahead. Assists the driver to stay in lane with gentle steering impulses. Informs driver if car is drifting out of lane unintentionally above 37mph. Choice of two settings: early steering intervention with continuous steering impulses to centre vehicle in lane, or late steering intervention, which alerts driver that vehicle is potentially crossing lanes and applies corrective steering prompt	●	£308.33	£370.00

Options are subject to availability and may extend delivery.

- = Not available
- = Available
- S = Standard

RRP – Recommended Retail Price.

VAT is calculated at 20% but this may alter to reflect any change in the applicable VAT rate.



Steering wheels and controls packs

Audi exclusive

With Audi exclusive, you can choose a luxurious leather steering wheel or controls pack in a choice of colours from the Audi exclusive range.

Order Code		RS 5	Basic RRP	Total RRP inc VAT
YRH S3G	Audi exclusive leather-covered steering wheel*	●	£304.17	£365.00
YRB S3G	Audi exclusive leather controls package*. Includes leather-covered steering wheel and gear-shift gaiter	●	£512.50	£615.00
YUC S3G	Audi exclusive suede controls package in black – includes steering wheel rim and gearshift knob in black suede. Stitching colour can be specified in a variety of colours from the Audi exclusive range	●	£629.17	£755.00

Options are subject to availability and may extend delivery.

– = Not available
 ● = Available
 S = Standard

*The leather, stitching and leather piping (where applicable) can be selected from any of the Audi exclusive colours shown on page 32.

RRP – Recommended Retail Price.

VAT is calculated at 20% but this may alter to reflect any change in the applicable VAT rate.



Audi Complete

Audi Complete is simply a way to look after the servicing and maintenance costs for your Audi in a single package. You pay a one-off or monthly fee and we'll cover all your servicing, maintenance and tyres for the next three years, including your first MOT. It means you only have to pay for fuel, insurance and your Road Fund Licence. So you can be reassured that your car will be maintained by trained Audi Technicians, using genuine Audi parts.

*Retail customers only. Pricing based on 3 years/30,000 miles (whichever occurs sooner). All pricing is a 'starting from' price for the Audi RS 5 model range and is therefore subject to change and mileage/model dependent.

Warranty

Options are subject to availability and may extend delivery.

- = Not available
- = Available
- S = Standard

**Only available prior to registration of your Audi RS 5. Please speak to your Audi Centre for full details.

RRP - Recommended Retail Price.

VAT is calculated at 20% but this may alter to reflect any change in the applicable VAT rate.

Order Code		RS 5	Basic RRP	Total RRP inc VAT
-	Audi Complete - Service and Maintenance. Comprehensive care for your Audi covering all your servicing and maintenance for 3 years, as well as your first MOT. Visit your local Audi Centre for further information or audi.co.uk/audicomplete for full details including terms and conditions	●	£55.83	£67.00*
-	Audi Complete - Service, Maintenance and Tyres. Comprehensive care for your Audi covering all your servicing, maintenance and tyres for 3 years, as well as your first MOT. Visit your local Audi Centre for further information or audi.co.uk/audicomplete for full details including terms and conditions	●	£87.50	£105.00*

Order Code		RS 5	Basic RRP	Total RRP inc VAT
-	Audi Warranty , covering you for unlimited mileage in the first two years of ownership, and up to 60,000 miles in the third year. Transferable between owners**	S	No charge	No charge
EA6	Audi Warranty , covering you for up to 4 years or 75,000 miles, whichever comes soonest. Cover includes a two-year unlimited-mileage warranty, and up to 75,000 miles in the third and fourth years. Transferable between owners**	●	£445.83	£535.00
EA9	Audi Warranty , covering you for up to 5 years or 90,000 miles, whichever comes soonest. Cover includes a two-year unlimited-mileage warranty, and up to 90,000 miles in the third, fourth and fifth years. Transferable between owners**	●	£1,045.83	£1,255.00

Merchandise

From the enthusiasts' motorsport collection to the sophisticated Audi collection, there's a wide variety of adults' and children's clothing, lifestyle accessories and collectables, all of which bear the Audi name.

Please speak to a member of our team at your local Audi Centre to see the full Audi collection and to place an order. A selection of Audi merchandise is also available to buy from audi.co.uk/merchandise.



RS 5 Cabriolet technical data

Engine	4.2 FSI quattro
Transmission	7-speed S tronic
Cylinder	8-cylinder
Displacement, cubic cm (valves per cylinder)	4163
Max. power ¹ , PS	450
Max. torque, Nm	430/4000-6000
Top speed, mph*	155
0-62mph acceleration, seconds	4.9
CO ₂ emissions ² , g/km	249
Benefit in kind (BIK)%	35%
Fuel consumption ² , mpg (l/100km) Urban	19.3 (14.6)
Fuel consumption ² , mpg (l/100km) Extra Urban	33.2 (8.5)
Fuel consumption ² , mpg (l/100km) Combined	26.4 (10.7)
ABI insurance group 1-50**	TBC
Unladen weight ³ , kg	1920
Gross weight limit, kg	2420
Roof load limit/nose weight ⁴ , kg	75
Max trailer load unbraked ⁴ , kg	N/A
Max trailer load with 12% gradient ⁴ , kg	N/A
Max trailer load with 8% gradient ⁴ , kg	N/A
Luggage compartment capacity, litres ⁵	380/750
Fuel tank capacity approx, litres	61

*Electronically limited. Please see page 41 for option to increase limit.

**Highest insurance group rating shown. Group may be lower dependent on trim level. Please visit www.thatcham.org/wabigrouprating for details.

¹The given value was obtained in accordance with the specified measurement procedure (the respective current version of Directive 80/1269/EEC).

²Fuel consumption and CO₂ emissions figures are obtained under standardised test conditions (Directive 93/116/EEC) using a representative model. This allows direct comparison between different models from different manufacturers, but may not represent the actual fuel consumption achieved in 'real world' driving conditions. More information is available at www.vca.gov.uk.

³Vehicle's unladen weight without driver (calculated in accordance with the current version of Directive 92/21/EEC). The fitting of additional equipment may increase the vehicle's unladen weight and drag coefficient, whereupon the potential carrying capacity and top speed will be correspondingly reduced.

⁴Vehicle not suitable for towing equipment.

⁵Second value; loaded up to roof with rear seat folded down.



RS 5 Cabriolet dimensions

The technical drawings opposite show the exact dimensions of the RS 5 Cabriolet, so you can check everything – from whether the car will fit in your garage to whether your luggage will fit in the boot.

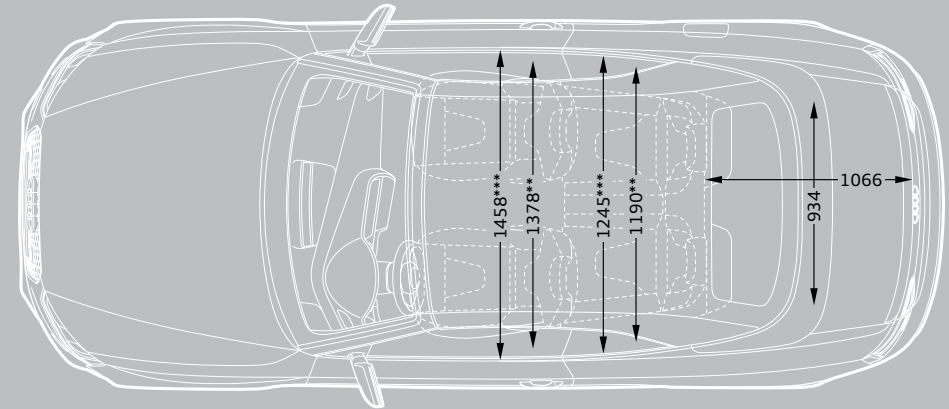
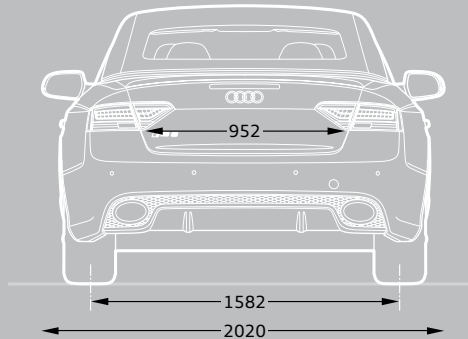
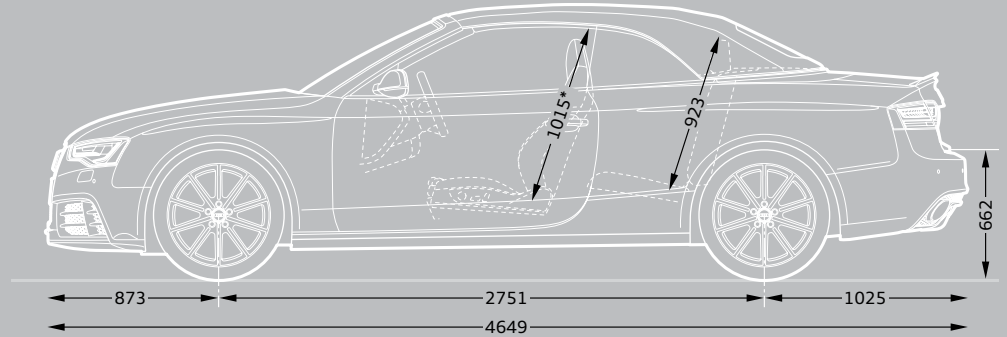
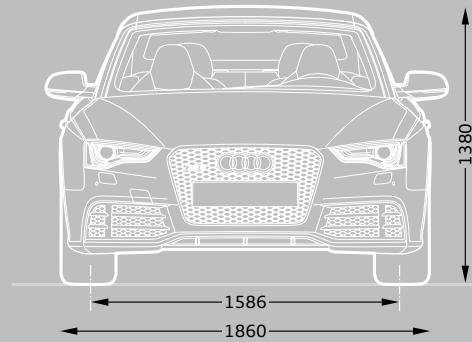

Dimensions in millimetres

- *Maximum headroom
- ** Shoulder room width
- *** Elbow room width

Dimensions were measured with vehicle at unladen weight, ground clearance measured with vehicle carrying its maximum load.

Luggage compartment volume in litres: 380/750 (measured by the VDA standard test method using 200 x 100 x 50mm blocks; second value: with rear seat folded down). Turning circle approx. 11.6m.

Additional information

CO₂ data and information

CO₂ emissions-based Vehicle Excise Duty

Vehicle Excise Duty (Road Fund Licence) is based upon the amount of Carbon Dioxide (CO₂) a vehicle emits, measured in grams per kilometre (g/km).

First year VED rates apply to the first year of ownership. Annual VED rates apply thereafter. The DVLA has created thirteen categories:

Petrol and Diesel engines	First year	Annual rate (second year onwards)
A – up to 100g/km	£0.00	£0.00
B – 101 to 110g/km	£0.00	£20.00
C – 111 to 120g/km	£0.00	£30.00
D – 121 to 130g/km	£0.00	£100.00
E – 131 to 140g/km	£120.00	£120.00
F – 141 to 150g/km	£135.00	£135.00
G – 151 to 165g/km	£170.00	£170.00
H – 166 to 175g/km	£275.00	£195.00
I – 176 to 185g/km	£325.00	£215.00
J – 186 to 200g/km	£460.00	£250.00
K – 201 to 225g/km	£600.00	£270.00
L – 226 to 255g/km	£815.00	£460.00
M – over 255g/km	£1,030.00	£475.00

Vehicle Excise Duty (VED) rates correct at time of going to print, but these may alter to reflect any change in the applicable VED rate

Servicing tailored to your needs

Regular servicing is key to safeguarding your Audi's performance and a full Audi service history could help you preserve the future re-sale value. To make servicing easy, the Audi Service Schedules have been designed to work with your individual driving style and vehicle.

There are two schedules available and your Audi Centre will advise which schedule is most suited to your needs. The conventional fixed Audi Inspection Service schedule has fixed intervals for the Oil-change and Inspection Service that are based on time and distance, whichever comes first.

With the Audi LongLife Service schedule, sensors take account of driving style and conditions in which the vehicle is used to indicate when the Oil-change Service is required. Oil-change Service intervals are therefore variable and are conveniently indicated via the on-board service interval display.

Audi Complete

When selecting the option of Audi Complete your vehicle should be placed on the following service schedules dependent on your mileage per annum:

- ▶ Under 10,000 miles per annum – Fixed Inspection Service Schedule
- ▶ Over 10,000 miles per annum – LongLife Service Schedule

Fixed Inspection Service Schedule

	Vehicle usage:
Mileage	Less than 10,000 miles per annum
Type of journey	Mainly city/town centre driving. Short journeys
Conditions	Frequent cold starts. High engine loading – e.g. frequent hill climbs, vehicle fully loaded, towing
Driving style	Uneconomical – e.g. heavy acceleration, heavy braking, constant changes in speed, constant use of high revs, 'sporty' driving
	Service Intervals:
Oil-change Service	Fixed to every 9,000* miles/1 year
Inspection Service	Fixed to every 19,000* miles/2 years

Variable LongLife Service Schedule

	Vehicle usage:
Mileage	More than 10,000 miles per annum
Type of journey	Motorway and main road driving. Mainly longer distance journeys. Constant speeds
Conditions	Normal engine loading – e.g. with little or no towing, with little or no hill climbs. Normal vehicle loading
Driving style	Moderate acceleration, moderate braking, engine revs mainly below 3,000
	Service Intervals:
Oil-change Service	Variable to a maximum of every 19,000* miles/2 years
Inspection Service	Fixed to every 19,000* miles/2 years

*As indicated by the service interval display. Mileages are approximate as the Service Indicator system uses kilometres as its distance measurement.

Additional information

Welcome to Audi

By placing an order for your Audi, you're choosing to get behind the wheel of one of the most sophisticated cars on the road. And because we believe the service we offer should be just as advanced, we wanted to let you know exactly what you can expect from us, now and in the future.

We've agreed a set of standards with all our Centres, which governs the way we do business with you. It outlines the kind of service we promise to deliver for every customer, right down to filling each new Audi we sell with half a tank of fuel.

So whether you're interested in the date your car will arrive in the UK or the way we'll dispose of non-biodegradable materials after we service your Audi, you can have total confidence in us.

Audi Promise

Audi Centres

We guarantee that all of our Centres will be open as follows:

Sales: Monday to Friday 9am–6pm
Saturday 9am–5pm

Service: Monday to Friday 8am–6pm
Saturday 8.30am–1pm

Sunday opening is at local discretion.

New car delivery

Once we've confirmed a delivery date for your car, we'll keep you informed of progress. Subject to reasonable notice, we'll then deliver it to a place of your choice, whether that's your home or place of work. In the unlikely event of a delay, we'll provide a courtesy car to minimise inconvenience and keep you mobile.

The experts in Vorsprung durch Technik

Would you entrust your Audi to anyone who hasn't been regularly trained to Audi standards? Our network of Audi Approved Master Technicians have undergone an impressive 100,000 hours of training over a 10-year programme to ensure they have the latest technical expertise for maintaining and servicing your Audi. All of our Service Advisors undergo a specialist induction and training to ensure they are Audi professionals and able to talk to you about any issues you may have with your Audi vehicle. What's more, we have so much expertise and experience in looking after Audi vehicles that we are able to make a note of your mileage and the state of your vehicle as and when we see it and predict when certain key events may occur. As part of our commitment to you, we will notify you in plenty of time so you can make an appointment with us.

Your convenience comes first

At Audi you can choose from a range of convenient services that suit your needs. Why not book a 'service while you wait' appointment* and enjoy our complimentary refreshments while your car is with us? Or, if you need to be mobile, take advantage of one of our courtesy cars which we can even collect and deliver to you.* We guarantee we can service your Audi within 5 days without a courtesy car, or within 10 days if you need transport. We will also ensure your car is returned to you with a full valet.

Audi Genuine Parts

Would you put a part into your Audi that wasn't the same quality as the factory fitted original? You can rest assured that only Audi Genuine Parts will be used on your vehicle. What's more, Audi parts and labour come with a 2-year guarantee.** We stock a wide variety of parts, so we are well covered. However, if we don't have a part in stock at our Centre we have the back-up of parts at other Audi Centres, at our national warehouse and our factory and can usually source the relevant part very quickly.

We don't like surprises either

We believe strongly in transparency and there will be no hidden costs. For added peace of mind, we will give you a quotation over the phone for the work you have requested and email you the price confirmation. We'll consult you if any additional work on your car is needed when it is with us. We won't carry out any extra work without asking your permission first.

The Audi Stamp

Regular servicing is key to safeguarding your Audi's performance and a full Audi service history could help you preserve the future re-sale value of your car. Only the Audi Stamp will prove your approved Audi service history.

Getting better every time

We continually gather feedback from our Audi Trained Technicians, as well as our customers, to ensure our vehicles are running as they should. Whenever we see an Audi for a service, we connect it directly to our headquarters in Ingolstadt which enables us to check your car's software and make sure it's as up-to-date as possible. If the factory has released a software upgrade for your model, it can be applied immediately – improving anything from your car's efficiency to the precision of its parking system.

Environmental commitment

We promise to dispose of all non-biodegradable materials from your vehicle in a responsible manner.

*Subject to availability.

**Excludes wear and tear.

Pricing information

Pricing

Prices and specifications given are correct at the time of printing. Always check details with your Audi Centre, as Audi policies are continually developing. We reserve the right to change prices or specifications at any time.

All prices are subject to VAT, currently charged at 20% but this may alter to reflect any change in the applicable VAT rate.

Delivery charges and number plates are not included in the vehicle price.

Delivery charge	£471.66
Number plate	£20.00
VAT	£98.34
Total	£590.00

Audi Roadside Assistance

Your new car comes complete with 3 years' complimentary roadside assistance and recovery across the UK provided by RAC Motoring Services. Also included is roadside assistance throughout Europe, managed by RAC Motoring Services.

Audi Customer Care

Every new Audi benefits from the comprehensive Audi Customer Care Package, which comprises:

- ▶ A 3-year Audi warranty, which covers you for unlimited mileage in the first 2 years of ownership, with a full mechanical and electrical warranty which covers you for up to 60,000 miles in the 3rd year
- ▶ A 3-year paint warranty
- ▶ A 12-year anti-corrosion warranty
- ▶ 3 years' UK roadside assistance and recovery

You also have the option when ordering your new car of choosing a 4-year or 5-year Audi warranty. Speak to a member of the sales team for more information.

Audi Tax-Free Sales

If you are entitled to purchase a vehicle free of VAT, normally through Military or Diplomatic privilege, please contact your local Audi Centre for full details.

Should you have any difficulty obtaining the information you require, please call Freephone 0800 585878.

Audi Finance

Audi Finance specialise in providing funding solutions for Audi drivers. Whether your Audi is for private or business use, there are a range of funding options to choose from.

Below is the full range of finance products:

- ▶ Solutions – a Personal Contract Plan
- ▶ Hire purchase
- ▶ Lease purchase
- ▶ Finance lease
- ▶ Contract hire

With all products, you can choose a fixed-cost maintenance plan designed to help you budget accurately.

No matter what Audi model you choose, your local Audi Centre can provide you with a personalised quote which could fit your budget and motoring needs.

Audi Finance is a trading name of Volkswagen Financial Services (UK) Limited. An offer of finance depends on certain conditions. Available to people over 18 in the UK only.

Audi Insurance

We want you to start enjoying your new car from day one and thanks to Audi Insurance complimentary seven day cover, you can. Call free on 0800 316 7893 (lines are open Monday to Friday 8am - 9pm, and Saturday 9am - 5pm), provide a few details and a cover note will be sent to your Audi Centre. They will then tax your car and you can drive it away.

Audi Insurance is a trading name of Volkswagen Insurance Service (Great Britain) Limited, an appointed representative of Volkswagen Financial Services (UK) Limited, Brunswick Court, Yeomans Drive, Blakelands, Milton Keynes MK14 5LR. Registered in England number 2835230. Audi Insurance is sold, underwritten and administered by Allianz Insurance plc registered in England number 84638. Registered office 57 Ladymead, Guildford, Surrey GU1 1DB. Volkswagen Financial Services (UK) Limited and Allianz Insurance plc are authorised and regulated by the Financial Services Authority. Volkswagen Financial Services (UK) Limited and Allianz Insurance plc are not part of the same corporate group.



Audi UK

Customer Services
Selectapost 29
Sheffield
S97 3FG
0800 699888
audi.co.uk

Specifications and prices subject
to change without notice.

© Audi UK

Printed in the UK
Edition 1.1 01/13
2013 model year

Images are for illustrative purposes only.

