



The new Audi RS 6 Avant

Pricing and Specification Guide
Valid from May 2013

Personalising your Audi RS 6 Avant

This guide has been designed to help you tailor and price your Audi RS 6 Avant quickly and logically. At the back, you will find information on CO2 emissions-based taxation and the other services offered by Audi, including Finance and Insurance. You can also configure your Audi RS 6 Avant online at audi.co.uk.

Audi Vision

To accompany this printed guide, we've created Audi Vision – an intuitive app that lets you find out even more about the Audi RS 6 Avant. Compatible with Apple and Android phones and tablets, Audi Vision gives you exclusive access to images, information and video content – all of which is designed to help you explore and understand the options available with this model.

You'll see the Audi Vision logo printed next to the page number on pages throughout this guide and wherever you do, you'll be able to view additional content on that page.



The Audi RS 6 Avant

Engine	12
Transmission	13
Technology	14

Model details and prices

Standard model equipment	18
Model prices	22

Audi exclusive	24
-----------------------	----

Colour and upholstery

Paint	26
Upholstery and seats	30
Colour and trim guide	34

Inlays	38
---------------	----

Options

Wheels and tyres	44
Performance	45
Audio and communication	46
Interior equipment	48
Steering wheels	48
Exterior equipment	49
Safety and security	51

Looking after your Audi

Warranty	56
Merchandise	59
Audi Difference	60

Technical details

Technical data	61
Dimensions	62
Pricing and Additional information	63





Vorsprung durch Technik

Three words that express the very essence of Audi. Vorsprung durch Technik isn't a slogan. It's our way of seeing the world. It is the driving force behind our history of innovation that continues into the 21st century. Indeed, many technologies that Audi pioneered remain in our cars today. Some are milestones in the history of the motorcar.

From our beginnings in 1899, to the Auto Union team's Grand Prix successes in the 1930s and our more recent wins at Le Mans, we have always been at the forefront of the motor industry.

Vorsprung durch Technik makes us who we are. To see more of its influence, just read on.





Introducing the RS 6 Avant

The RS story has unfolded over the last fifteen years, delivering a series of elegant yet supremely powerful models. The RS 6 Avant is no exception. As a direct descendant of our most exciting high-performance models, it's the culmination of many years of technical expertise – on roads and racetracks all over the world. Here, the story continues: with more responsiveness and efficiency than you ever thought possible.









RS 6 Avant interior story

We've introduced a number of finishing touches to the Audi RS 6 Avant interior to make your driving experience unique. You'll find an impressive attention to detail in everything from the luxurious honeycomb design Valcona leather to our optional customised stitching, which means that every journey you make will be a personal one.

Engine

Petrol

An innovative 4-litre V8 TFSI® engine sets the RS 6 Avant apart – and keeps it there. That's because it features Le Mans-winning fuel-injection technology, which enhances fuel efficiency, power and torque. But this unit is capable of more than just raw power; it also knows how to use it. Ultra-lightweight construction and intelligent engine technologies like cylinder-on-demand mean the RS 6 Avant can make effortless, efficient work of every move. The one from 0-62mph in only 3.9 seconds is perhaps the most impressive.



Transmission

Tiptronic®

The RS 6 Avant features an 8-speed tiptronic transmission with DSP (Dynamic Shift Programme). It's a gearbox that gives you the best of both worlds. Choose between the smooth, economical and uninterrupted power of an automatic, or use the steering wheel paddles or gear lever to switch to manual mode: for a more dynamic drive on inclines and winding roads.

As well as enabling crisp, fast gear changes, tiptronic uses the car's navigation data to tailor itself to your individual driving style, optimising the shifting strategy it uses for different manoeuvres to deliver a more responsive, fuel-efficient drive.

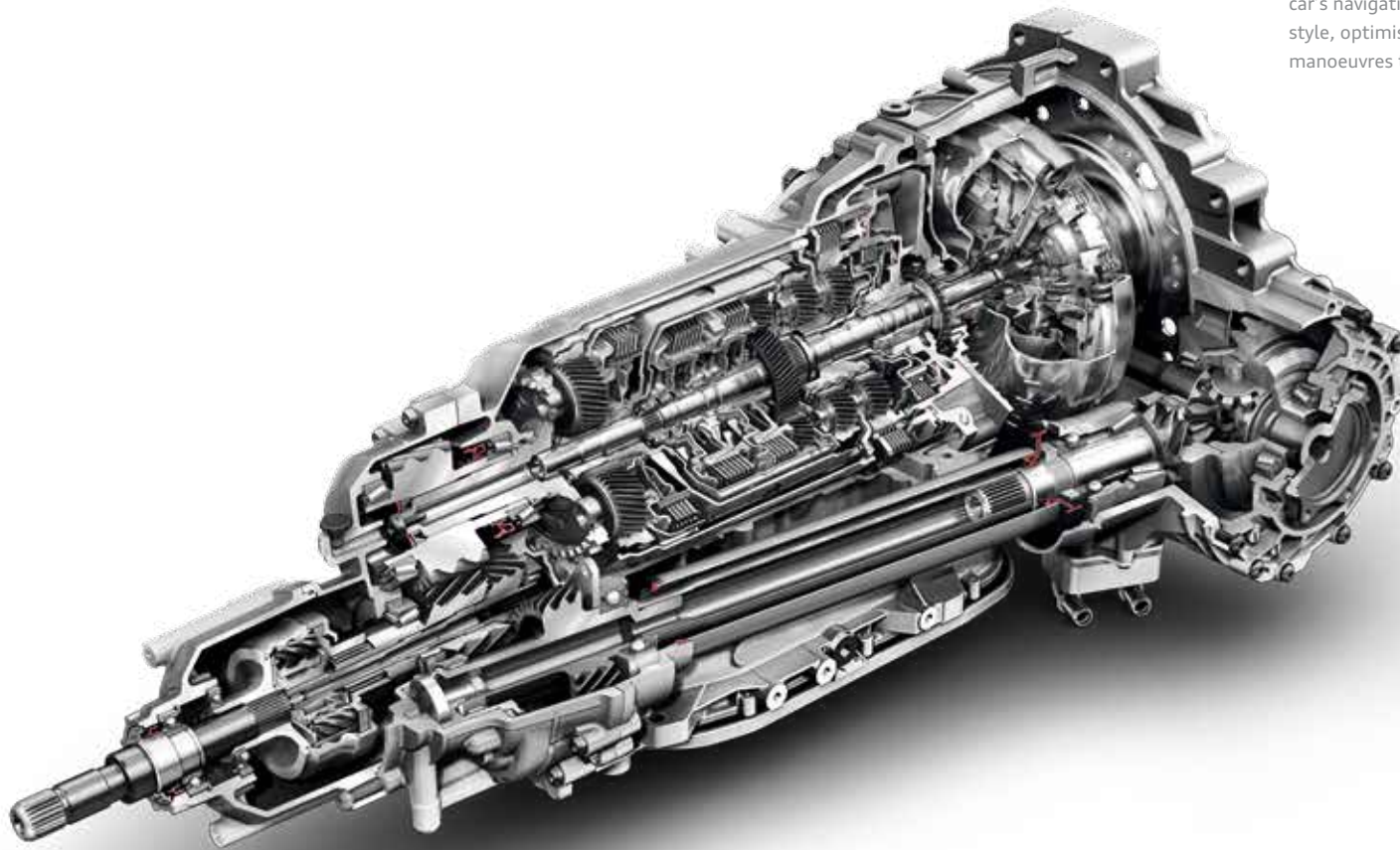

Technology

quattro® with Sports differential

The Audi RS 6 Avant features the very latest generation of quattro® permanent all-wheel-drive – the exclusive road-holding technology that’s helped Audi dominate the racetrack ever since 1980. Two decades and many evolutions later, quattro® is 2.5kg lighter, more compact and now features Sports differential. This advanced, electronically regulated technology distributes different amounts of drive force to each rear wheel, ensuring outstanding acceleration performance and stability when cornering. It also lessens the effort required to steer, for even more agile handling.

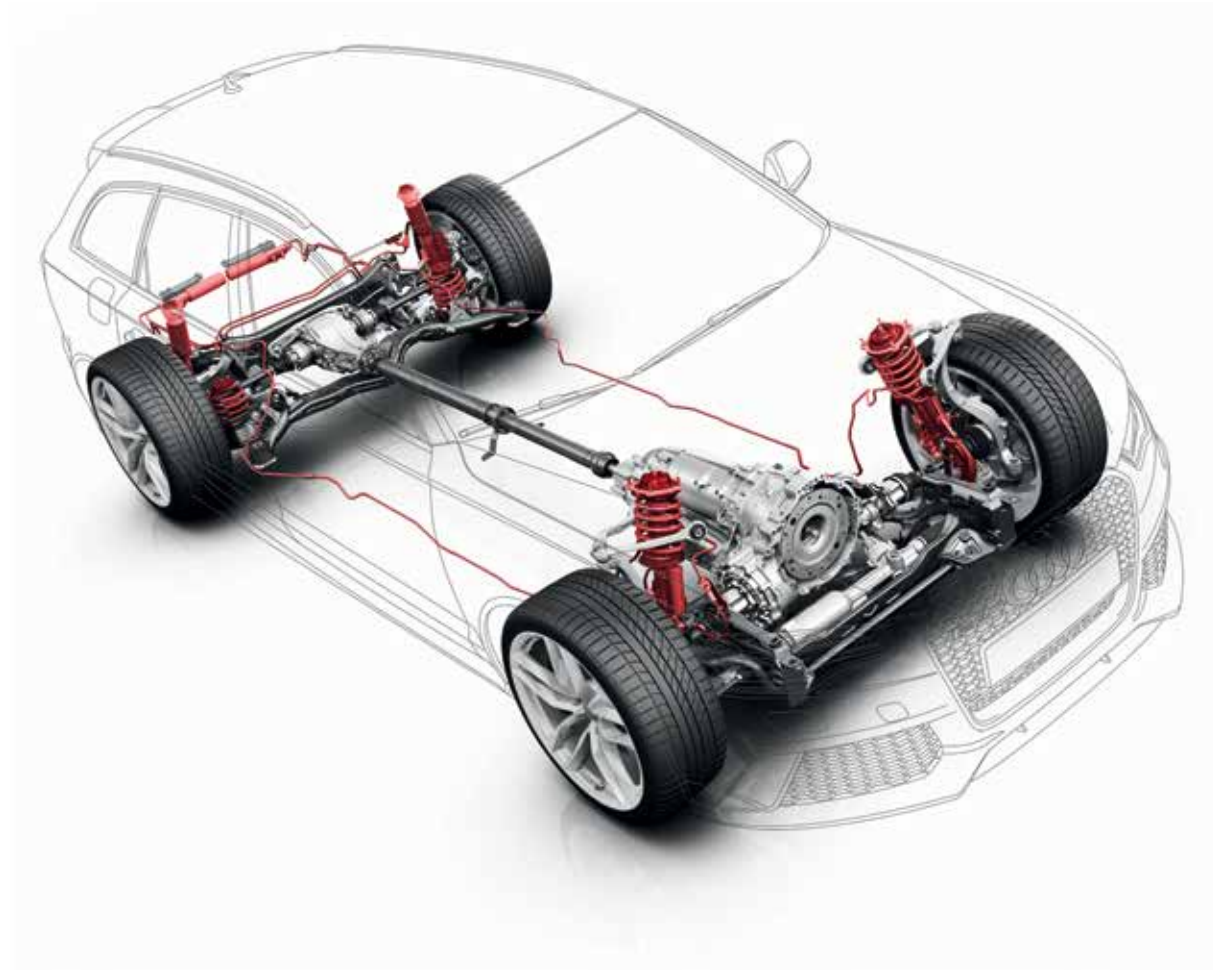



High-performance braking system

A car as powerful as an RS needs an equally powerful system to slow it down. This takes the form of 19-inch RS brakes, with 6-piston fixed callipers on the front axle. Each brake disc is internally ventilated and perforated for enhanced performance, while a special 'floating' friction ring improves stability under high temperature loads.

For even greater strength and thermal resistance with an added weight-saving, you can opt for 20-inch ceramic brakes on your RS 6 Avant. See page 45 for full details.

Cylinder-on-demand technology

High performance doesn't necessarily equate to higher fuel consumption – as proven by the engine in the new RS 6 Avant. Advanced cylinder-on-demand technology automatically shuts down four of eight cylinders when they're not needed - for example when coasting at constant speed on the motorway or in city traffic - so you'll benefit from the efficiency and low emissions of a car with a much smaller engine. Then, once you reach the open road, the V8 comes back into its own. The switch from one mode to another barely registers – except, perhaps, in your pulse rate.





Standard model equipment

All RS 6 Avant models have the following items of standard equipment

The RS range incorporates some of our most exclusive, dynamic and sporty models. But in the unmistakable RS 6 Avant, you will find not only the high performance and sophistication you'd expect, but also a surprising level of functionality that makes this a great car for everyday use.

Engine and transmission

75 litre fuel tank

Audi cylinder-on-demand technology

Wheels, tyres and suspension

20" x 9.5J '7-twin-spoke' design alloy wheels with 275/35 R20 tyres and locking wheel bolts

Audi drive select. Changes your car's handling and response at the touch of a button to suit the way you want to drive. Enables the driver to alter the throttle response, the shift point of the automatic transmission, RS Adaptive air suspension, exhaust flap control and the power steering feel between the three pre-set modes: comfort, dynamic, auto or individual mode

quattro® permanent all-wheel-drive with Sports differential – the electronically regulated Sports differential distributes variable amounts of driving force to each rear wheel, ensuring outstanding acceleration performance when cornering and stabilising the vehicle's response to load change. It also ensures better direct steering characteristics and, thanks to less steering effort, more agile handling

RS-specific Adaptive air suspension. Electronically controlled air suspension with infinitely variable adaptive damping system on all four wheels, with RS-specific tuning. This automatically controls the vehicle level and damping, with four modes: comfort, dynamic, auto and lift, which can all be selected via the MMI system

RS high-performance braking system with brake callipers painted in high-gloss black, and RS logo at the front

Electromechanical power steering

Tyre Mobility System

Seats

ISOFIX child seat mounting for front passenger (with airbag deactivation) and outer rear seats

Valcona leather upholstery

RS Super Sports front seats with driver's side memory function including:

- Stitched honeycomb quilted design with embossed RS logo
- Electrically adjustable seat height
- Electrically adjustable upper backrest angle
- Electrically adjustable seat cushion angle
- Electrically adjustable seat forwards and backwards position
- 4-way electric lumbar support

Heated front seats

Split-folding rear seats



20" x 9.5J '7-twin-spoke' design alloy wheels



Valcona leather with honeycomb design and embossed RS logo

Exterior equipment

Metallic and pearl effect paint

RS body styling

- Flared front and rear wheel arches
- Front bumper with enlarged air inlets
- Front spoiler
- Honeycomb design grille
- Rear diffuser
- Roof spoiler
- Side sill extensions

Matt-finished aluminum-look door mirror housings, window capping strips, radiator grille frame and front spoiler

Roof rails in matt aluminium

Dual-branch exhaust system with two oval tailpipe trims

Xenon all-weather headlights with LED daytime-running lights

Adaptive lights – includes swivelling headlights for improved illumination of a winding road, and dynamic cornering light function which pivots the headlights based on the movement of the steering wheel (operational between speeds of approximately 6mph and 68mph). Turning-light function is activated when the indicator is switched on (up to speeds of 45mph). The headlights have three different light distribution modes: town light, motorway light, or country light, which are adjusted according to speed or via navigation route data. Additional functionality via navigation-based vehicle support includes junction light, which provides a wide front light setting, as well as travel mode, which switches between right and left-hand drive modes assisted by GPS data

High-beam assist. Variable headlight range control featuring a camera on the interior mirror which registers sources of light from other road users. The range and width of the headlight beam are continuously varied between dipped and main beam to suit ambient conditions, ensuring that the headlights provide good visibility without dazzling other road users

Headlight washers

Darkened rear LED lights

Exterior mirrors – heated, electrically adjustable, electrically folding and auto-dimming, with automatic kerb view function which tilts the passenger mirror downwards towards the kerb when reverse gear is engaged. Includes memory function

Power-operated boot lid. Opens by pressing the button on the radio-operated remote control key, the button in the driver's door panel or the soft-touch button in the tailgate handle recess; closes by a button on the inside of the tailgate, button in the driver's door or with optional Advanced key (press and hold). Includes power-assisted closing. There is also a functional electric luggage compartment cover. When the boot lid is opened, the luggage compartment cover is automatically drawn back along its rails and then returns when the boot lid is closed

Tow bar bracket preparation – the set of parts for retrofitting is available from Audi Accessories or available as an option (see page 49)



Honeycomb structured grille



Roof spoiler



LED rear lights

Standard model equipment

Continued

Interior equipment

RS 3-spoke flat-bottomed leather multi-function steering wheel with gear shift paddles in aluminium-look, contrast stitching and RS emblem

Electrically adjustable steering column – adjustable for height and reach with auto easy entry and exit function, and with memory

Inlays in Carbon

Aluminium-look pedals and footrest

Cruise control – maintains any speed above 18mph, provided the engine power output and engine braking effect permit it; operated via separate steering column stalk. The set speed is displayed in the Driver's Information System

Auto-dimming rear-view mirror – uses a photocell to recognise when the headlights behind are too bright and dims automatically

Colour Driver's Information System (DIS) with 7" display with energy-saving tips and rest recommendations. Shows the radio station or track title, telephone control, menu and other display information from the infotainment system, such as navigation and on-board trip computer with short and long-term trip memory, outside temperature display, digital speedometer and door or boot-open warning. Also includes RS menu with gear changing light, charging pressure and lap timer

Deluxe 4-zone automatic air conditioning. Includes front control panel with digital display, as well as separate temperature control for the driver and front passenger sides. There are additional controls with digital display in the rear with separately adjustable temperature and blower settings for right and left side (rear functions can be set from the front controls). There are also added air vents in the B-pillars and automatic recirculation by means of air quality sensor, use of residual heat, separate regulation of footwell temperature and ventilated glove compartment. There are a choice of three climates: gentle, medium and intensive

Ambient lighting package – Includes lighting for the interior and exterior

Interior:

- Entrance lighting
- 2 reading lights at front and rear
- Anti-glare LED illumination for the passenger compartment
- Vanity mirrors at front
- Ambient lighting of the centre console
- Ambient reflected light for inside door trims
- Lighting for door pockets, footwells, and inside door handles
- Reflected lighting for centre console and door inner panels
- Surround lighting for centre console
- Illuminated door sill trims with RS 6 logo
- Glove compartment and luggage compartment lighting

Exterior:

- Courtesy light on the underside of the door handles and LED door handle lighting for easy entry and exit in the dark
- Automatic activation when the doors are unlocked
- Active internal door reflectors



RS 3-spoke flat-bottomed steering wheel



Inlays in Carbon

Audio and communication

MMI Navigation Plus including MMI Touch.

Hard disk navigation with topographical map display, places of interest and town models in 3D. Destinations can be entered via the speech dialogue system or MMI Touch, including 7-digit postcode recognition. The system offers three alternative routes, with the ability to scroll along the selected route and manoeuvre within the map. Includes 8" colour display with split-screen mode for route information, dynamic route guidance (TMC), intersection zoom function, motorway exits and lane recommendations in Driver's Information System (DIS). Incorporates MPEG4-compatible DVD player and two SDHC memory card readers (for cards of up to 32GB). Hard drive for music storage up to 20GB. Also includes vehicle support based on navigation data including: adaptation of transmission, lights and adaptive cruise control with Stop&Go function (depending on options fitted). This system is still available even when navigation is deactivated

MMI Radio Plus

DAB digital radio reception. Receives programmes from digital radio transmitters in addition to the range of analogue stations with better sound quality. With the DAB twin tuner, a second DAB tuner permanently searches for alternative reception frequencies of the set

station, and the station list is updated at the same time. Please note – reception depends on local digital network availability. It is also capable of receiving DAB+ and DMB audio signals

BOSE® surround sound

- 14 speakers including centre speaker in the dashboard and subwoofer under the boot floor
- 2 surround sound speakers in the D-pillar
- 12-channel amplifier with a total output of over 600 Watts
- Acoustics specially tuned to the interior
- Surround sound reproduction 5.1
- AudioPilot for noise-compensating volume adjustment
- Powerful, precise bass reproduction

Mobile telephone preparation – Bluetooth interface. Bluetooth-compatible mobile phones can be connected to the vehicle via the interface, allowing handsfree calls via the microphone. Also includes Bluetooth audio streaming (dependent on mobile phone capability)

Audi Music Interface. Universal connection for use with stereo audio sources, USB and MP3 devices including Apple iPod generation 4 onwards (iPod, iPod classic, iPod nano, iPod photo, iPod video, iPod touch). Provides intuitive control through the audio system and multi-function steering wheel. It also replicates the iPod display on the MMI audio screen

and DIS, including track titles. The interface provides charging function (dependent on device). Includes 2 cables to connect your iPod or USB MP3 player device

Safety and security

Airbag System featuring 6 airbags. Full-size airbags for driver and front passenger. Front side airbags integrated into the seat backrests with additional head airbag system over the entire length of the side windows and protects the front and outer rear passengers in the event of a side impact

Electromechanical parking brake – includes parking brake function when stationary, drive-off assistance function through automatic release when driving away and emergency braking function whilst driving, acting on all 4 wheels

Hill-hold assist holds the vehicle stationary for unlimited periods after stopping on upward and downward slopes

Audi parking system plus, acoustic and visual parking assist system for front and rear

Rest recommendation system – analyses driving behaviour based on steering, pedals and gear lever movements. If the system detects a change in driving patterns it can notify the driver of the possible need to take a rest via the audio and visual effects

Light and rain sensor – automatically switches the dipped beam headlights and windscreen wipers on/off depending on the light and rain conditions. Also includes coming home/leaving home function which delays the deactivation of the front and rear lights after locking, and automatically activates the lights when unlocking

Tyre pressure monitoring system – provides a visual and acoustic warning of pressure loss in one or more tyres; defective tyre is displayed in the Driver's Information System

Electronic Stability Control (ESC), with two-stage deactivation. Providing better stability by targeted braking of individual wheels and intervention in the engine management system

Antilock Brake System (ABS)

Anti-Slip Regulation (ASR)

Electronic Differential Lock (EDL)

First-aid kit

Tool kit and car jack

Warning triangle

Thatcham category 1 alarm



RS instrument panel including RS gear shift light, with Piano black trim surround



Door sill trims with aluminium inlays and RS 6 logo

RS 6 Avant

Engine	Power	Transmission	CO ₂ g/km	Basic RRP	Total RRP inc VAT	Recommended OTR
4.0 TFSI	560PS	8-speed tiptronic	229	£62,916.67	£75,500.00	£76,985.00

Please note: The maximum power output figures are quoted in PS (or Pferdestärke, which is the metric equivalent of brake horsepower). To convert to brake horsepower, divide the PS figure by 1.0139.

Recommended On-The-Road (OTR) retail prices include: delivery charge, half a tank of fuel, number plates at £590.00 (inc. VAT), Road Fund Licence (which may vary depending on model/transmission; see page 64 for details) and first registration fee at £55.00. Vehicle Excise Duty correct at time of going to print, but this may alter to reflect any change in the applicable VED rate.

RRP – Recommended Retail Price. VAT is calculated at 20% but this may alter to reflect any change in the applicable VAT rate.







Audi exclusive

Every Audi is intrinsically exclusive. It's the breathtaking design, the exceptional engineering, the Vorsprung durch Technik. But for that special touch you can specify your new RS 6 Avant with options from Audi exclusive. Whether you want a unique, custom-mixed paint colour or seats in a combination of complementary shades, Audi exclusive will enable you to drive the car you've always imagined.

Both the exclusive and standard options can be found on the following pages.



Paint

We believe that every part of your car should have a personal touch. Which is why you can choose from a wide range of paint colours and finishes, from standard shades to metallic and pearl effects. We can even mix a customised colour for you to create the perfect fit.



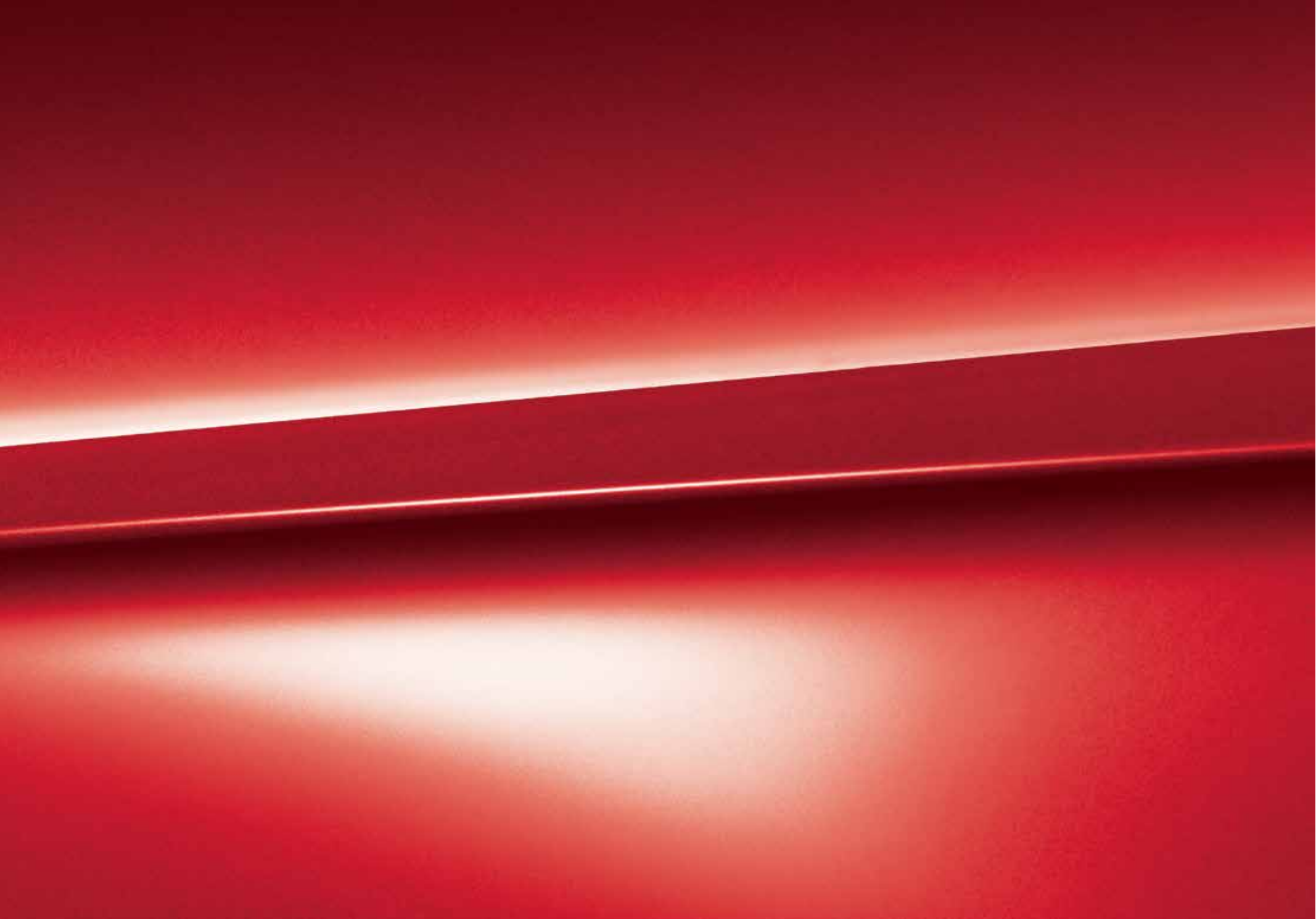

Paint

You can select the standard colours shown opposite or, for a different look, choose from a range of optional finishes.

Options are subject to availability and may extend delivery.

All the colour swatches on this page are matched as accurately as possible to the actual paint colours used. However, due to print processes, Audi UK cannot guarantee that colours shown are 100% accurate.

Visit your local Audi Centre for a more accurate colour swatch.

RRP – Recommended Retail Price.

VAT is calculated at 20% but this may alter to reflect any change in the applicable VAT rate.

Standard colours



Ibis white – T9

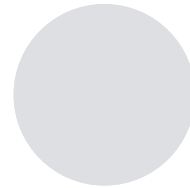

Suzuka grey, metallic – M1

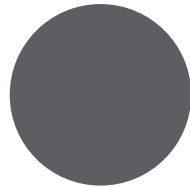

Nardo grey – T3

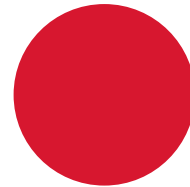

Misano red, pearl effect – N9

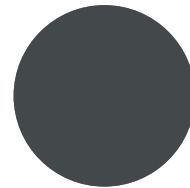

Daytona grey, pearl effect – 6Y

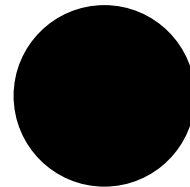

Phantom black, pearl effect – L8

Crystal effect

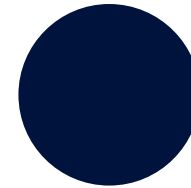

Estoril blue, crystal effect – K0



Prism silver, crystal effect – T0

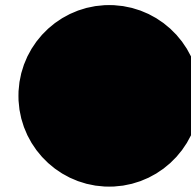

Panther black, crystal effect – H8

Matt colour

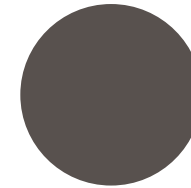

Daytona grey, matt – I6

Crystal effect paint

Basic RRP
£208.33

Total RRP inc VAT
£250.00

Matt paint

Basic RRP
£4,729.17

Total RRP inc VAT
£5,675.00

Paint

Audi exclusive

Everyone has a favourite colour. No matter what yours is, Audi exclusive provides a range of unique colours that have been designed to set your car apart. Choose from the swatches here, or specify any other paint colour in the Audi range. Whether it's Sepang blue from the Audi R8 or Alpine white from the original Audi quattro, the choice is yours.

Customised paint

If you have a particular colour in mind, we'll mix the exact metallic or pearl-effect shade you want.*

*Customised paint is subject to factory approval, and is available for metallic and pearl-effect water-based paints only. Three-colour process colours and two-tone schemes are not available.

**Visit your local Audi Centre for colour samples.

All the colour swatches on this page are matched as accurately as possible to the actual paint colours used. However, due to print processes, Audi UK cannot guarantee that colours shown are 100% accurate.

Visit your local Audi Centre for a more accurate colour swatch.

RRP - Recommended Retail Price.

VAT is calculated at 20% but this may alter to reflect any change in the applicable VAT rate.

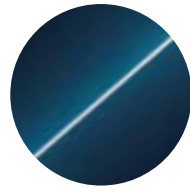

Palace blue, pearl effect

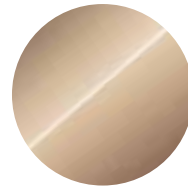

Sand beige, pearl effect

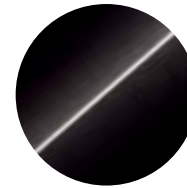

Saddle brown, pearl effect

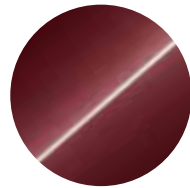

Classic red, pearl effect

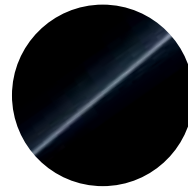

Mamba black, metallic

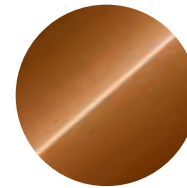

Ipanema brown, metallic



Any colour in the Audi range or 100 exclusive colours to choose from**



Customised paint

Audi exclusive

Basic RRP
£1,250.00

Total RRP inc VAT
£1,500.00

Customised*

Basic RRP
£1,666.67

Total RRP inc VAT
£2,000.00

Upholstery

It's important to feel comfortable on the road. Just choose from our range of luxury upholstery materials and textures, including additional heating and colour options, for complete relaxation while you drive.





Upholstery

RS embossed front Super Sports seats

Choose your favourite upholstery from the swatches shown opposite to give your car's interior the look and feel you want.

You can also order Comfort seats as shown below.

Comfort seats – PS8

Includes memory function for driver and front passenger seat.

Comfort seats are only available in combination with Seat ventilation (4D3/4D8).



Comfort seats are not available in honeycomb quilted design and will remove RS embossing.

Options are subject to availability and may extend delivery.

- = Not available
- = Available
- S = Standard

RRP – Recommended Retail Price.

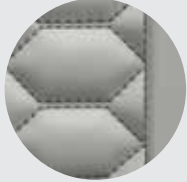
VAT is calculated at 20% but this may alter to reflect any change in the applicable VAT rate.

		RS 6 Avant	Basic RRP	Total RRP inc VAT
Valcona leather - honeycomb quilted design	 <p>Black with Rock grey stitching – UB/QI</p>	S	No charge	No charge
	 <p>Lunar silver with Rock grey stitching – QO/SO</p>			
Leather/Alcantara - diamond stitched design	 <p>Black – QH/UO</p>	•	No charge	No charge
Valcona leather	 <p>Black – QH/UO</p>	•	£229.17	£275.00

Seats

Choose from a variety of different seat options so you can maintain the right driving comfort at all times.

Order Code		RS 6 Avant	Basic RRP	Total RRP inc VAT
4D3	Seat ventilation for front seats. Three different intensities of cool air drawn through the seat for active ventilation of the seat-centre section and thigh support. To allow for the seat ventilation, the leather of the seat front is perforated. Only available in combination with Comfort seats (PS8)	●	£700.00	£840.00
4D8	Massage and seat ventilation for front seats. Massage function with five different programs (wave, pulse, stretch, lumbar, shoulders) and four levels of intensity for massaging the muscles with the help of ten pneumatic cushions. Ventilation with three different intensities of cool air drawn through the seat for active ventilation of the seat-centre section and thigh support. To allow for the seat ventilation, the leather of the seat front is perforated. Only available in combination with Comfort seats (PS8)	●	£1,333.33	£1,600.00
4A4	Heated front and rear seats. Works in the same way as front seat heating, enabling you to regulate the rear seats separately	●	£83.33	£100.00

Options are subject to availability and may extend delivery.

- = Not available
- = Available
- S = Standard

RRP – Recommended Retail Price.

VAT is calculated at 20% but this may alter to reflect any change in the applicable VAT rate.

Colour and trim guide

Interior trim colours

RS embossed front Super Sports seats

Use this guide to help you choose the right interior for your Audi RS 6 Avant. It shows the carpet, dashboard and headlining colours that have been matched to your chosen upholstery.

In combination with interior colour codes QI/SO/UO, please add silver headlining (6N).

Order code	Upholstery	Carpet	Dashboard	Headlining	Valcona leather (N5M)	Leather/Alcantara (N7S)
UB/QI	Black with Rock grey stitching	Black	Black	Black/Silver	●	—
QO/SO	Lunar Silver with Rock grey stitching	Black	Black	Black/Silver	●	—
QH/UO	Black	Black	Black	Black/Silver	—	●

Comfort seats

Comfort seats are not available in honeycomb quilted design and will remove RS embossing.

Order code	Upholstery	Carpet	Dashboard	Headlining	Valcona leather (N5D)
QH/UO	Black	Black	Black	Black/Silver	●

Options are subject to availability and may extend delivery.

- = Not available
- = Available
- S = Standard



Upholstery

Audi exclusive

With Audi exclusive, you can specify your seats in Valcona leather in an array of different colours shown to the right.

Select just one all-over shade for each seat, or customise each panel in two or more complementary colours from the distinctive Audi exclusive palette. You can even choose the colour of the decorative stitching – to match or contrast with your chosen upholstery – from this varied collection. Whatever combination you decide upon, we think you'll be extremely satisfied with the result.



Chestnut brown



Jet grey



Alabaster white

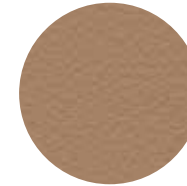

Sand beige

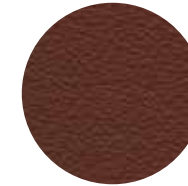

Saddle brown

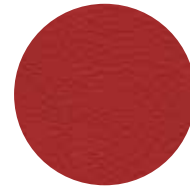

Crimson red



Magnolia white



Havana brown

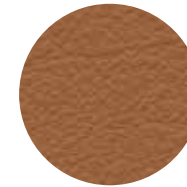

Cognac brown

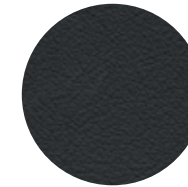

Night blue

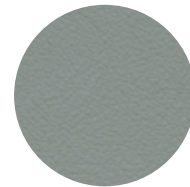

Cloudy grey

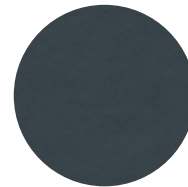

Smoky blue

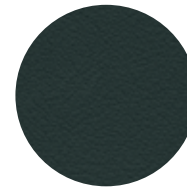

Iceland green



Powder beige

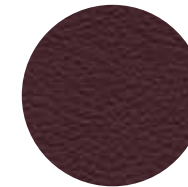

Classic red

Options are subject to availability and may extend delivery.

– = Not available
• = Available
S = Standard

*Leather and stitching colours (where applicable) can be specified in a variety of colours from the Audi exclusive range.

RRP – Recommended Retail Price.

VAT is calculated at 20% but this may alter to reflect any change in the applicable VAT rate.

Also available:

Carpet colours: available in all the Audi exclusive colours shown.

Please consult your Audi Centre for examples of carpet colours.

Upholstery

Audi exclusive

Order Code		RS 6 Avant	Basic RRP	Total RRP inc VAT
PYQ S3G	Audi exclusive leather package 1 in Valcona leather with honeycomb quilted design.* Includes Valcona leather-covered seat upholstery, head restraints, door trim inserts, front centre armrest and lower centre console. Seat centre sections for the front and outer rear seats in honeycomb quilted design. Also includes RS 6 embossing on the front-seat backrests. Only available in combination with interior trim codes UB/QO	●	£4,583.33	£5,500.00
PYS S3G	Audi exclusive leather package 2 in Valcona leather with honeycomb quilted design.* Includes all of the contents of leather package 1 (PYQ) plus leather-covered door armrests and front-seat backrest covers. Seat side trims and add-on parts are colour-coordinated. Only available in combination with interior trim codes UB/QO	●	£7,641.67	£9,170.00
PYO S3G	Audi exclusive design package in Valcona leather with honeycomb quilted design. Includes Valcona leather-covered seat upholstery, head restraints, door trim inserts, front centre armrest, door armrests and lower centre console all in black with crimson red contrast stitching. Seat centre sections for the front and outer rear seats in honeycomb quilted design. Also features RS 6 embossing on the front-seat backrests. Includes floor mats in black with leather piping in crimson red (YSR), controls with crimson red contrast stitching (YRB) and seat belts in crimson red (YTO)	●	£7,666.67	£9,200.00
PYC S3G	Audi exclusive leather package 1 in Valcona leather/Alcantara with diamond stitching design.* Includes Valcona leather-covered seat side sections, head restraints, front centre armrest and lower centre console. Front seat centre sections and outer rear seats in Alcantara with diamond stitching design. Door trim inserts in Alcantara. Also includes RS 6 embossing on the front-seat backrests	●	£4,166.67	£5,000.00
PYB S3G	Audi exclusive leather package 1 in Valcona leather for Comfort seats.* Includes Valcona leather-covered seat upholstery, head restraints, door trim inserts, front centre armrest and lower centre console. Also includes RS 6 embossing on the front-seat backrests. Comfort seats are not available in honeycomb quilted design. Only available in combination with seat ventilation (4D3/4D8)	●	£4,395.83	£5,275.00
PYR S3G	Audi exclusive leather package 2 in Valcona leather for Comfort seats.* Includes all of the contents of leather package 1 (PYB) plus leather-covered door armrests and front-seat backrest covers. Also includes RS 6 embossing on the front-seat backrests. Comfort seats are not available in honeycomb quilted design. Only available in combination with seat ventilation (4D3/4D8)	●	£7,454.17	£8,945.00
YYA S3G	Audi exclusive piping for Comfort seats.* Only available in combination with Audi exclusive leather packages 1 or 2 for Comfort seats (PYB/PYR)	●	No charge	No charge
YTO S3G	Audi exclusive seat belts*	●	£1,375.00	£1,650.00
YSR S3G	Audi exclusive floor mats.* Includes front and rear floor mats	●	£395.83	£475.00
YTZ S3G	Audi exclusive black floor mats with RS logo. Includes front and rear floor mats in black with stitching and piping in black	●	£441.67	£530.00
YTU S3G	Audi exclusive floor mats with RS logo.* Includes front and rear floor mats in black with stitching and piping colour freely selectable	●	£620.83	£745.00
YSQ S3G	Audi exclusive carpet and floor mats.* Not available in combination with any of the other Audi exclusive floor mats (YSR/YTZ/YTU)	●	£1,750.00	£2,100.00

Options are subject to availability and may extend delivery.

- = Not available
● = Available
S = Standard

*Leather and stitching colours (where applicable) can be specified in a variety of colours from the Audi exclusive range.

RRP – Recommended Retail Price.

VAT is calculated at 20% but this may alter to reflect any change in the applicable VAT rate.

Inlays

Attention to detail can make a big impact. From contemporary black Piano finish to matt-brushed aluminium, our selection of inlays make the perfect finishing touch to your car's interior.





Inlays

Inlays are the all-important finishing touch that add flair and interest to your car's interior. Choose from the range of sleek inlays shown opposite.

Order Code		RS 6 Avant	Basic RRP	Total RRP inc VAT
5MB	Carbon. Covers centre console, door trims and the continuous inlay seam, with aluminium-look edging	S	No charge	No charge
5TG	Matt-brushed aluminium. Covers centre console, door trims and the continuous inlay seam	●	No charge	No charge
5TL	Piano finish, black. Covers centre console, door trims and the continuous inlay seam, with aluminium-look edging	●	No charge	No charge
5TB	Aluminium, beaufort black. Covers centre console, door trims and the continuous inlay seam, with aluminium-look edging	●	£1,041.67	£1,250.00

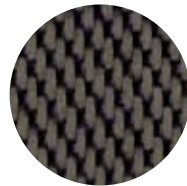

Carbon – **5MB**

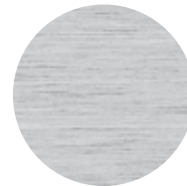

Matt-brushed aluminium – **5TG**

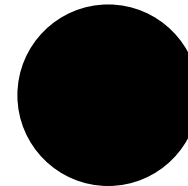

Piano finish, black – **5TL**



Aluminium, beaufort black – **5TB**

Options are subject to availability and may extend delivery.

- = Not available
- = Available
- S = Standard

RRP – Recommended Retail Price.

VAT is calculated at 20% but this may alter to reflect any change in the applicable VAT rate.

Inlays

Audi exclusive

Audi exclusive has sourced a varied range of materials from which to craft these elements.

Order Code		RS 6 Avant	Basic RRP	Total RRP inc VAT
YTA S3G	Audi exclusive inlays	●	£1,083.33	£1,300.00



Fine grain ash, nougat

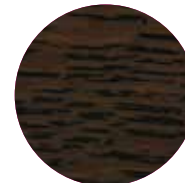

Oak, sepia



Fine grain myrtle, nutmeg



Modrone wood, gold



Vavona wood, bronze



Tamo ash, natural dark brown

Options are subject to availability and may extend delivery.

- = Not available
- = Available
- S = Standard

RRP – Recommended Retail Price.

VAT is calculated at 20% but this may alter to reflect any change in the applicable VAT rate.

Options

Every driver has different needs, which is why we have created some useful options to further enhance your car. For extra comfort, support, style or function, you can choose from a variety of additional features, tailoring everything from your infotainment and audio equipment to your wheels and lighting.



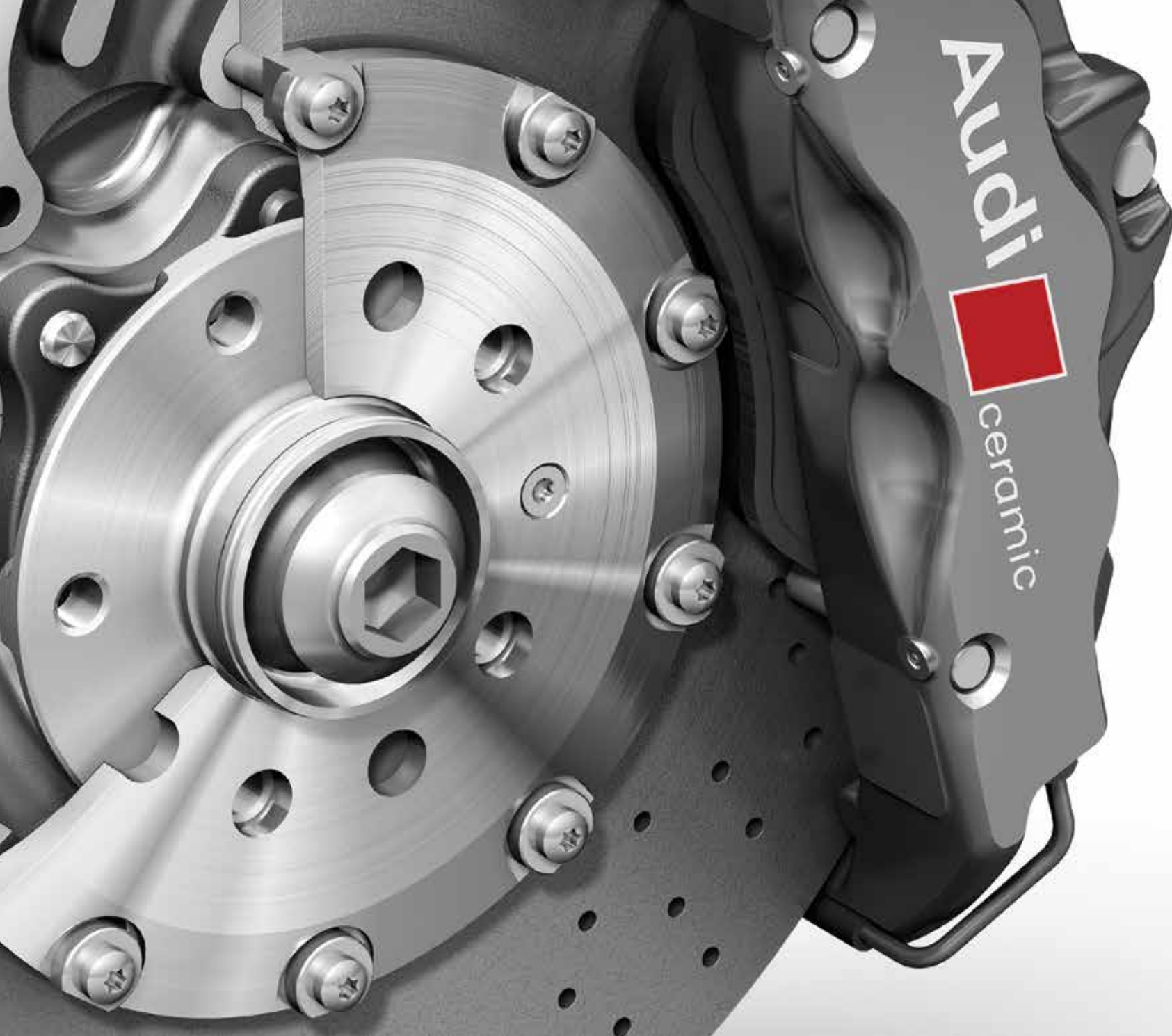

Wheels and tyres

Choose a set of specially-selected alloy wheels to subtly enhance the way your car looks and drives.

Order Code		RS 6 Avant	Basic RRP	Total RRP inc VAT
PQ7	21" x 9.5J '5-twin-spoke' design polished alloy wheels with 285/30 R21 tyres	●	£1,583.33	£1,900.00
PQR	21" x 9.5J '5-twin-spoke' design titanium-look alloy wheels with 285/30 R21 tyres	●	£1,666.67	£2,000.00
PQ4	21" x 9.5J '5-twin-spoke' design black-gloss alloy wheels with 285/30 R21 tyres	●	£1,666.67	£2,000.00



21" x 9.5J '5-twin-spoke' design polished alloy wheels – PQ7



21" x 9.5J '5-twin-spoke' design titanium-look alloy wheels – PQR



21" x 9.5J '5-twin-spoke' design black-gloss alloy wheels – PQ4

Options are subject to availability and may extend delivery.

- = Not available
- = Available
- S = Standard

RRP – Recommended Retail Price.

VAT is calculated at 20% but this may alter to reflect any change in the applicable VAT rate.

Performance

We've developed a whole range of performance options to complement the capabilities of the RS 6 Avant – everything from an increased top speed to a high performance brake system.

Options are subject to availability and may extend delivery.

*Where the law permits

– = Not available

• = Available

S = Standard

RRP – Recommended Retail Price.

VAT is calculated at 20% but this may alter to reflect any change in the applicable VAT rate.

Order Code		RS 6 Avant	Basic RRP	Total RRP inc VAT
PA2	Dynamic Package. Includes a top speed restriction increase to 174mph*, RS sports suspension plus with Dynamic Ride Control (2MC), Dynamic steering (1N8) and All-LED headlights including high-beam assist (PX2). Please note this option forces the removal of tow bar bracket preparation (1D0)	•	£1,729.17	£2,075.00
PA3	Dynamic Package Plus. Includes a top speed restriction increase to 189mph*, Ceramic brakes (PC5), RS sports suspension plus with Dynamic Ride Control (2MC), Dynamic steering (1N8) and All-LED headlights including high-beam assist (PX2). Please note this option forces the removal of tow bar bracket preparation (1D0)	•	£8,937.50	£10,725.00
2MC	RS sports suspension plus with Dynamic Ride Control (DRC). Enhanced suspension setup which consists of a special shock absorber system that counteracts pitch and body roll movement without using any electronic devices. With DRC, diagonally opposed shock absorbers on the car are linked together hydraulically. A central valve varies the shock absorber operating characteristic, for instance when the steering wheel is turned and the car is cornered, so that movement around the longitudinal axis (roll) is significantly reduced. DRC uses the same principle to counteract body movement around the transverse axis (pitch) when the car is accelerated or braked. There is a choice of three settings; comfort, dynamic or auto. Please note this option forces the removal of tow bar bracket preparation (1D0)	•	£833.33	£1,000.00
1N8	Dynamic steering. Improves comfort and handling by dynamically regulating steering according to the driving situation. Allows steering feel to be adapted to road speed and the chosen Audi drive select mode. With this technology, driving is significantly more agile under everyday conditions, while directional stability and precision are increased at high speeds and in demanding driving situations. Also enhances active safety with corrective steering inputs if critical situations are detected	•	£1,008.33	£1,210.00
OP6	Sports exhaust. Oval-shaped, high-gloss black dual-exhaust pipes which further enhances the engine sound	•	£833.33	£1,000.00
PC5	Ceramic brakes. 20-inch high-performance brake system with carbon-fibre reinforced, ventilated and perforated ceramic brake discs. Brake callipers are painted in high-gloss anthracite with 'Audi ceramic' logo on front. Benefits include extremely high level of wear resistance and enhanced fading resistance due to a lower sensitivity to high thermal loads	•	£7,208.33	£8,650.00



Standard brake callipers painted in high-gloss black with RS logo



Ceramic brakes – front

Audio and communication

Stay in touch using our range of communication functions, and give each journey its own soundtrack with our advanced audio equipment.

Order Code		RS 6 Avant	Basic RRP	Total RRP inc VAT
8RF	<p>Bang & Olufsen Advanced Sound System.</p> <ul style="list-style-type: none"> - 15 speakers including subwoofer and centre speaker, each with their own amplifier channel for genuine 5.1 surround sound - 10-channel DSP full-digital amplifier with a total output of over 1,200 Watts, fully digitised with highly efficient 5-channel ICEPower amplifier for woofers and subwoofer - When switched on, two acoustic lenses extend from the dashboard for excellent sound rendition and perspective from all seats - Polished aluminium speaker covers - Acoustics specially tuned to the interior through the targeted use of tweeters, mid-range speakers and woofers - Speakers in encapsulated housings isolate music and telephone conversations within the vehicle for privacy - when making phone calls in handsfree mode, for instance - Automatic adjustment of volume to the driving situation <p>Please note that this option will reduce the boot space</p>	●	£5,250.00	£6,300.00
9ZF	<p>Mobile telephone preparation – Low. Uses Bluetooth interface or cradle to connect to your vehicle, using the car's own GSM antennae for optimal reception and charging. A phone adaptor is required at extra cost - please contact your Audi Centre for phone compatibility</p>	●	£145.83	£175.00
9ZW	<p>Mobile telephone preparation – High with Audi connect. Audi connect provides access to a number of innovative online services via an internal UMTS (3G) module. Audi connect online services include: navigation using Google Earth images and Google Street View, destination entry via Google Maps or myAudi, online point of interest search and information services such as weather forecasts and the latest world news. Audi connect also includes Audi traffic information online, which gives accurate real-time forecasts of the traffic situation along the chosen route. The traffic situation can be displayed on the navigation map or Google Earth image. Audi connect can also create a Wi-Fi hotspot in the car for convenient internet access using a mobile device (e.g. laptop or tablet). Many Audi connect features can be simply operated via MMI Navigation Plus, the multi-function steering wheel or the voice control system.</p> <p>Important connectivity information: An external data source is required to enable the Audi connect online services. One of the two following external data sources can be used¹:</p> <ol style="list-style-type: none"> 1. A mobile telephone with Bluetooth SIM Access Profile² 2. A separate SIM card which can be inserted in the included SIM card reader. When a separate SIM card is used, hands free phone calls are possible using the SIM card or by connecting a different mobile telephone via Bluetooth Hands Free Profile 	●	£291.67	£350.00
7A2	<p>CD changer in the glove compartment – for 6 CDs, MP3 and WMA-compatible, shock-resistant, easily accessible and each CD can be loaded and changed individually. Also supports UDF file system (Windows Vista). Music files with digital rights management (DRM) cannot be played</p>	●	£366.67	£440.00
6G0	<p>CD changer and DVD player in glove compartment – for 6 DVDs or CDs. Supports audio CDs, video DVDs and MP3, WMA, AAC, MPEG4 and playlists as well as UDF file system (Windows Vista); supports up to 4,000 tracks per medium; shock-resistant and easily accessible in the glove compartment; DVDs and CDs can be changed individually; fast forward, rewind and random playback possible. Music files with digital rights management (DRM) cannot be played</p>	●	£570.83	£685.00

Options are subject to availability and may extend delivery.

- = Not available
- = Available
- S = Standard

¹Online services are only available for mobile phone contracts or SIM cards which include a data option and only within the coverage of the mobile phone network; there may be additional costs for the use of these services (charges and billing correspond to the personal mobile phone contract or SIM card contract). Due to high data volumes, a mobile phone contract including an unlimited or high usage data plan is strongly recommended. The content and scope of the online based services offered may vary.

²To check the compatibility of your mobile phone and whether it has SIM Access Profile compatibility, please visit www.audi.co.uk/owners-area/phone-compatibility.html

RRP – Recommended Retail Price.

VAT is calculated at 20% but this may alter to reflect any change in the applicable VAT rate.

Audio and communication

Stay in touch using our range of communication functions, and give each journey its own soundtrack with our advanced audio equipment.

Options are subject to availability and may extend delivery.

- = Not available
 • = Available
 S = Standard

RRP – Recommended Retail Price.

VAT is calculated at 20% but this may alter to reflect any change in the applicable VAT rate.

Order Code		RS 6 Avant	Basic RRP	Total RRP inc VAT
QU6	Digital TV reception. Reception of digital (DVB-T) uncoded television stations (MPEG-2 standard), TV picture, teletext and Electronic Programme Guide (EPG). Facility to connect 2 external AV sources via adapter cables (available from Audi Accessories). Please note that TV reception depends on local digital network availability. No AV or TV video output when driving (audio output available when driving)	•	£725.00	£870.00
9WQ	Audi Entertainment Mobile. A rear seat entertainment system which includes two 9" screens* supplied by Audi Genuine Accessories which can be easily fitted and includes the ability to connect modern storage devices such as Bluetooth interface, CD/DVD-drive, SD-card slot, USB-interface and AV-IN/OUT. Includes a carry case for player and accessories, remote control, table-top stand, battery for 2.5 hours' external player time, charging lead, head phones, operating instructions and a bonus DVD. The back of both front seats are fitted with mountings and wiring and the system can also be used outside the car with the rechargeable battery. Only available in combination with Comfort seats (PS8)	•	£875.00	£1,050.00
KS1	Head-up display. An optical system of mirrors project driving-related information directly into the driver's field of vision. To prevent ghost images, a special windscreen with a wedge-shaped film is fitted. This film measures approximately 26 x 9cm in size, and the driver perceives the display to be 2 to 2.5m beyond the windscreen. The display has many benefits: - Helps to increase safety, convenience and driving pleasure - Straightforward operation via MMI - Display is height-adjustable, adjusts to ambient brightness - High resolution of up to 480 x 240 pixels - The following are displayed (depending on chosen option): - road speed - navigation instructions - adaptive cruise control status, distance from vehicle ahead and set speed - warning messages - infotainment lists - speed limit display	•	£1,033.33	£1,240.00



Bang & Olufsen Advanced Surround System



Head-up display

Interior equipment

Specify every detail of your car's interior with this range of exclusive options.

Order Code		RS 6 Avant	Basic RRP	Total RRP inc VAT
3Y3 6RB	Manual sun blind for rear window and rear door windows	●	£175.00	£210.00
3X2	Through-load facility with removable ski/snowboard bag for practical and safe transportation of long objects, e.g. up to 4 pairs of skis or 2 snowboards. Unrestricted use of the rear seats	●	£62.50	£75.00
3GN	Load-area fixing kit. Includes fixing set for the rail system in the luggage compartment, with telescopic pole and fastening strap for dividing up the luggage compartment	●	£133.33	£160.00
6SJ	Reversible luggage compartment mat (fabric/rubber) for luggage compartment. Velour on one side, rubber on the other, folds out to cover the luggage compartment	●	£91.67	£110.00
9JC	Smoking package (cigarette lighter and ashtray). Replaces 12V socket in front	●	No charge	No charge
6NA	Audi exclusive headlining in black Alcantara with black stitching*. Headlining, upper pillar trim and sun visors in black Alcantara with black stitching.	●	£1,845.83	£2,215.00
YUR S3G	Audi exclusive headlining in black Alcantara with contrast stitching*. Headlining, upper pillar trim and sun visors in black Alcantara with contrast stitching.	●	£2,250.00	£2,700.00

Steering wheels and controls packs

1XT	3-spoke leather multi-function Sports steering wheel – heated. Please note this option forces the removal of RS emblem on the steering wheel (6F0)	●	£166.67	£200.00
YRH S3G	Audi exclusive steering wheel*. Not available in combination with Audi exclusive controls package (YRB)	●	£458.33	£550.00
YRB S3G	Audi exclusive controls package*. Includes steering wheel rim and selector lever in leather. Not available in combination with Audi exclusive leather steering wheel rim (YRH)	●	£691.67	£830.00
YUC S3G	Audi exclusive controls package in black suede*. Includes steering wheel rim and selector level in black suede	●	£675.00	£810.00

Options are subject to availability and may extend delivery.

– = Not available
● = Available
S = Standard

*Leather and stitching colours (where applicable) can be specified in a variety of colours from the Audi exclusive range.

RRP – Recommended Retail Price.

VAT is calculated at 20% but this may alter to reflect any change in the applicable VAT rate.

Exterior equipment

Make sure your car looks exactly as you want it to, by selecting some of our striking options.

Options are subject to availability and may extend delivery.

- = Not available
- = Available
- S = Standard

* Additional wiring is required for auxiliary equipment.

RRP – Recommended Retail Price.

VAT is calculated at 20% but this may alter to reflect any change in the applicable VAT rate.

Order Code		RS 6 Avant	Basic RRP	Total RRP inc VAT
6FQ	Exterior mirror housings in carbon	•	£1,250.00	£1,500.00
4KF	Privacy glass. Dark-tinted rear and rear-side windows (from B-pillar backwards)	•	£325.00	£390.00
PDV	Heat/sound insulating glass. Windscreen, front side windows and rear side windows made of heat/sound insulating glass. Rear window features standard single-layer safety glass. The visible Vehicle Identification Number is displayed on the windscreen. Also includes a clear area in the upper section of the driver's side windscreen for toll road pass tags. Please consult your Audi Centre for more details. Only available in combination with Mobile phone preparation Low (9ZF) or High (9ZW). Not available in combination with privacy glass (4KF)	•	£875.00	£1,050.00
PDW	Heat/sound-insulating glass with privacy glass. Windscreen and front side windows made of heat/sound insulating glass. Rear and rear side windows feature tinted standard single-layer safety glass. The visible Vehicle Identification Number is displayed on the windscreen. Also includes a clear area in the upper section of the driver's side windscreen for toll road pass tags. Please consult your Audi Centre for more details. Only available in combination with Mobile phone preparation Low (9ZF) or High (9ZW)	•	£708.33	£850.00
3FU	Panoramic glass sunroof. Comprises two sections, where the front glass section can be tilted or slid open and closed again electrically. Includes electrically operated sun blind for the front and rear passengers. Can also be closed from the outside via the central locking	•	£1,020.83	£1,225.00
1D4	Tow bar. Ball head and ball joint coupling made from forged steel. Mechanically swivelling ball head, operated via Bowden cable, with indicator light on Bowden cable and display in instrument cluster to monitor secure attachment of trailer towing hitch; includes trailer stabilisation system via the Electronic Stability Control (ESC). Includes single European 13-pin electrics socket and may require a 13-to 7-pin adaptor. Please consult your Audi Centre for details*. Not available in combination with Carbon optic package (PQA), Sports suspension with variable damping (ZMC), Dynamic Package (PA2) or Dynamic Package Plus (PA3)	•	£687.50	£825.00



Exterior equipment

Make sure your car looks exactly as you want it to, by selecting some of our striking options.

Order Code		RS 6 Avant	Basic RRP	Total RRP inc VAT
GZ2	Power door closure. Automatically pulls doors that are not completely engaged into lock	●	£516.67	£620.00
ZZ0	Removal of model and technology designation	●	No charge	No charge
PQZ	Matt aluminium styling package including air intake duct with quattro logo. Side flaps and top edge of the rear diffuser insert in matt aluminium-look. Also includes matt aluminium-look air intake duct with the quattro logo in titanium grey	●	£720.83	£865.00
PQA	Carbon styling package including air intake duct with quattro logo. Front lip spoiler, side flaps and the rear diffuser insert in carbon. Carbon air intake duct with the quattro logo in titanium grey. Also includes the radiator grille frame, radiator grille and window capping strips in high-gloss black with roof rails in matt black. Please note this option forces the removal of tow bar bracket preparation (1D0)	●	£3,541.67	£4,250.00

Options are subject to availability and may extend delivery.

- Not available
- = Available
- S = Standard

* Additional wiring is required for auxiliary equipment.

RRP – Recommended Retail Price.

VAT is calculated at 20% but this may alter to reflect any change in the applicable VAT rate.



Matt aluminium styling package



Carbon styling package

Safety and security

Intelligent technology designed to give you better all-round awareness and safety on the road.

Options are subject to availability and may extend delivery.

- = Not available
- = Available
- S = Standard

*Where the law permits.

RRP – Recommended Retail Price.

VAT is calculated at 20% but this may alter to reflect any change in the applicable VAT rate.

Order Code		RS 6 Avant	Basic RRP	Total RRP inc VAT
PX2	All-LED headlights including high-beam assist. LEDs for all front lighting functions. LED technology provides lower energy consumption and enhanced contrast with a colour similar to daylight, for increased safety and good recognition by other road users. Includes all-weather light function to reduce the risk of the driver being dazzled when visibility is poor (in fog, rain or snow), turning light function which is activated when indicator is switched on (up to speeds of 45mph), and an additional motorway light which automatically increases headlight range at speeds above approximately 68mph. Also includes high-beam assist which automatically adjusts headlights from high-beam to dipped-beam when another vehicle is approaching or when other ambient lighting is detected (i.e. street lights) by a camera on the interior mirror	•	£708.33	£850.00
7X5	Park assist – searches for suitable parking spaces along the road by means of ultrasonic sensors, calculates the ideal parking path and performs the steering action virtually automatically. Steering is done by the vehicle; the driver need only accelerate and apply the brakes	•	£341.67	£410.00
KA2	Audi parking system advanced with reversing camera. An image of the area behind the vehicle is shown on the MMI display, with dynamic display modes showing the calculated path (steer-angle dependent); includes help lines, guidelines and identification of the point at which to apply opposite lock when parallel parking. The reversing camera is concealed in the handle strip of the tailgate	•	£333.33	£400.00
KA6	Audi parking system advanced with top view. Aids parking and manoeuvring using 4 cameras. Cameras are mounted in the front grille, the handle of the boot lid and the housing of the two exterior mirrors. The driver can choose between different image representations in the MMI display, including a live “bird’s eye view” image for parking	•	£750.00	£900.00



All-LED headlights including high-beam assist



Park assist

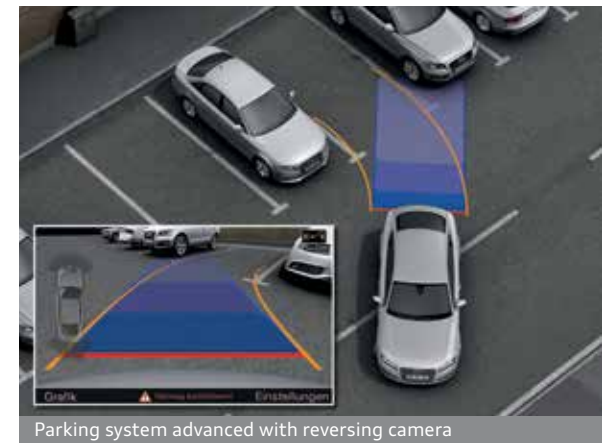

Parking system advanced with reversing camera

Safety and security

Intelligent technology designed to give you better all-round awareness and safety on the road.

Options are subject to availability and may extend delivery.

- = Not available
• = Available
S = Standard

*Where the law permits.

RRP – Recommended Retail Price.

VAT is calculated at 20% but this may alter to reflect any change in the applicable VAT rate.

Order Code	RS 6 Avant	Basic RRP	Total RRP inc VAT
7W1 Pre-sense basic. Audi pre-sense is a comprehensive technical package for identifying dangers well in advance and intervening appropriately. Pre-sense basic networks the different vehicle systems, enabling driving situations to be categorised and, where necessary, actions to be taken to protect the driver and passengers. These include: belt tightening, activating the hazard warning system, closing the windows and the sunroof (if fitted)	•	£216.67	£260.00
PCB Audi active lane assist. Helps the driver to stay in lane with gentle steering impulses for greater safety and convenience, particularly on motorways and country roads: - Informs driver if the car is drifting out of lane unintentionally above approximately 37mph - Driver has the choice of two system settings in the MMI: - Early steering intervention – continuously helps the driver to stay in lane with steering impulses that centre the vehicle in its lane - Late steering intervention – alerts the driver that the vehicle is possibly crossing the lane markings, at the same time as providing a corrective steering prompt - Additional warning in the form of vibrating steering wheel when lane markings are crossed (if specified by driver) - Camera identifies individual or coloured lane markings, e.g. yellow lines at roadworks - Additional indication in head-up display (if fitted)	•	£333.33	£400.00
PCH Audi side assist including pre-sense rear. Aids the driver when changing lane. Audi side assist monitors the area behind your car, using radar sensors located discreetly in the rear bumper, informing the driver with a visual warning signal in the door mirror if there is a vehicle in their blind spot or approaching quickly from behind. The system is activated using a button in the driver's door and works at speeds above 19mph. The airbags are also pre-conditioned	•	£437.50	£525.00
PCD Audi side assist including pre-sense rear and Audi active lane assist. Includes all the features of Audi side assist including pre-sense rear (PCH) and Audi active lane assist (PCB)	•	£770.83	£925.00

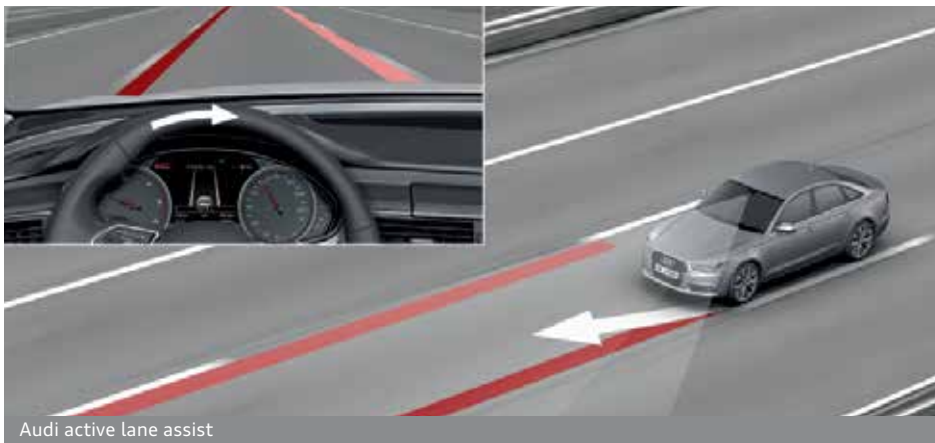

Safety and security

Intelligent technology designed to give you better all-round awareness and safety on the road.

Options are subject to availability and may extend delivery.

- = Not available
- = Available
- S = Standard

*Where the law permits.

RRP – Recommended Retail Price.

VAT is calculated at 20% but this may alter to reflect any change in the applicable VAT rate.

Order Code	RS 6 Avant	Basic RRP	Total RRP inc VAT
PCG Adaptive cruise control (ACC) with Stop&Go function including pre-sense front. Automatic distance regulation, using radar sensors to maintain required distance by braking and accelerating. Four programs (distance 1 to distance 4) set via steering column controls of the cruise control system. Works at speeds between 0 and 155mph* and also includes Audi braking guard – a system which triggers a visual and acoustic alarm when it detects the risk of a rear end collision with the vehicle in front. In addition, the airbags are pre-conditioned if a crash is sensed and the system is prepared to assist with the necessary braking force once the brake pedal is touched	•	£1,495.83	£1,795.00
PCN Adaptive cruise control with Stop&Go function, Audi side assist and Audi active lane assist with pre-sense plus. Includes all the features of PCG and PCD plus Audi pre-sense plus which, in a situation where a collision is inevitable, allows full brake application to try to lessen the impact of the collision	•	£1,879.17	£2,255.00
QR9 Speed limit display – the prevailing speed limit can be read on the Driver’s Information System (DIS). Should the camera fail to see a sign properly, the speed limit from the data for the navigation system will be shown instead. The advantages: – Display of the speed limits currently registered, which can be called up in the Driver’s Information System at any time – Display can be called up in every instrument cluster view and in the head-up display (if fitted) – Camera-based system is also capable of detecting temporary speed restrictions in roadworks and on digital displays (e.g. over motorways) within the system limits – Display of national speed limits for Western European countries Only available in combination with an assistance package (PCB/PCD/PCG/PCN)	•	£208.33	£250.00



Adaptive cruise control



Sensor for Adaptive cruise control

Safety and security

Order Code		RS 6 Avant	Basic RRP	Total RRP inc VAT
9R1	Night vision assistant with pedestrian detection – a thermal imaging camera (remote infrared with resolution of 320 x 240 pixels) registers heat dissipation in front of the vehicle and represents this image in the Driver's Information System (DIS). Image recognition software highlights people detected in the darkness in yellow, and if the system classifies them as being at risk, a warning bell is sounded and the image changes to red. The person detected is also illuminated by the headlights three times in succession to alert them to the danger. Warning can also be shown in head-up display (if fitted). System operation may be restricted in too much ambient light, high humidity and high night temperatures (over 28°C)	●	£1,258.33	£1,510.00
PGB	Audi hands-free boot opening system with Advanced key. Access and authorisation system that works through automatic data exchange between key and vehicle, allowing the driver to keep their car key in their pocket or bag at all times. To unlock and open, simply lift the exterior door handle. The door is locked by pressing the button on the handle. Pressing the start/stop button integrated in the centre console starts and stops the engine. Also allows the boot lid to be opened automatically by a simple kicking movement underneath the rear bumper. Not available in combination with Carbon styling package (PQA)	●	£479.17	£575.00
VC1	Garage door opener (HomeLink®*). Programmable radio remote control, with buttons integrated into the front roof module; can be used for opening garages and exterior gates	●	£204.17	£245.00
4X4	Rear side airbags. For the outer rear seats, incorporated into the seat backrests; supplement the side impact protection in the doors and the head airbag system	●	£312.50	£375.00

Options are subject to availability and may extend delivery.

- = Not available
● = Available
S = Standard

*Homelink® is a registered trademark of Johnson Controls. For information on compatibility, visit www.homelink.com.

RRP – Recommended Retail Price.

VAT is calculated at 20% but this may alter to reflect any change in the applicable VAT rate.



Night vision assistant with pedestrian detection



Looking after your Audi

When you've chosen your ideal model, it's reassuring to know that it will remain in safe hands. That's why we've created products to protect your Audi, from extended warranties to Audi Complete – our comprehensive service and maintenance package. And there's also a range of Audi accessories and merchandise to choose from, enabling you to further enhance and safeguard your car.





Warranty

Order Code		RS 6 Avant	Basic RRP	Total RRP inc VAT
-	Audi Warranty , covering you for unlimited mileage in the first two years of ownership, and up to 60,000 miles in the third year. Transferable between owners**	S	No charge	No charge
EA6	Audi Warranty , covering you for up to 4 years or 75,000 miles, whichever comes soonest. Cover includes a two-year unlimited-mileage warranty, and up to 75,000 miles in the third and fourth years. Transferable between owners**	●	£737.50	£885.00
EA9	Audi Warranty , covering you for up to 5 years or 90,000 miles, whichever comes soonest. Cover includes a two-year unlimited-mileage warranty, and up to 90,000 miles in the third, fourth and fifth years. Transferable between owners**	●	£1,795.83	£2,155.00

Options are subject to availability and may extend delivery.

- = Not available
- = Available
- S = Standard

**Only available prior to registration of your Audi RS 6 Avant. Please speak to your Audi Centre for full details.

RRP – Recommended Retail Price.

VAT is calculated at 20% but this may alter to reflect any change in the applicable VAT rate.

Merchandise

From the enthusiasts' motorsport collection to the sophisticated Audi collection, there's a wide variety of adults' and children's clothing, lifestyle accessories and collectables, all of which bear the Audi name.

Please speak to a member of our team at your local Audi Centre to see the full Audi collection and to place an order. A selection of Audi merchandise is also available to buy from audi.co.uk/merchandise



Audi Difference

The experts in Vorsprung durch Technik

Our Audi Approved Master Technicians have undergone an impressive 100,000 hours of training over a 10-year programme to ensure they have the latest technical expertise for maintaining and servicing your Audi. All our Service Advisors undergo a specialist induction and training to ensure they are Audi professionals and able to talk to you about any issues you may have with your Audi vehicle.

Servicing tailored to your needs

Regular servicing is key to safeguarding your Audi's performance and a full Audi service history could help you enhance the future re-sale value. To make servicing easy, the Audi Service Schedules have been designed to work with your individual driving style and vehicle.

We offer two different schedules: the fixed Inspection Service and the variable LongLife Service schedule. The conventional fixed Inspection Service schedule has fixed intervals for the Oil-change Service and Inspection Service, which are determined by time and distance.

With the variable LongLife Service schedule, the Inspection Service intervals are also fixed but the Oil-change Service intervals are variable. Sensors take account of driving style and conditions to determine when the Oil-change Service is required and the driver is informed via the on-board service interval display.

The choice of Service Schedule will depend on journey type and mileage as well as individual driving style and conditions. The table to the right can be used for guidance but your Audi Centre will help you to determine the most suitable Service schedule for you based on your individual circumstances and preferences.

Fixed Inspection Service Schedule

	Vehicle usage:
Mileage	Less than 10,000 miles per annum Mainly city/town centre driving. Short journeys.
	Service Intervals:
Oil-change Service	Fixed to every 9,000+ miles/1 year
Inspection Service	Fixed to every 19,000+ miles/2 years

Variable LongLife Service Schedule

	Vehicle usage:
Mileage	More than 10,000 miles per annum Motorway and main road driving. Mainly longer distance journeys. Constant speeds.
	Service Intervals:
Oil-change Service	Variable to a maximum of every 19,000+ miles/2 years
Inspection Service	Fixed to every 19,000+ miles/2 years

When a vehicle is frequently used in the following conditions, we recommend a Fixed Inspection Service Schedule, regardless of mileage:

Uneconomical driving styles, e.g. heavy acceleration and braking, constant use of high revs

High engine-loading conditions, e.g. frequent towing and hill climbs

*As indicated by the service interval display. Mileages are approximate as the Service Indicator system uses kilometres as its distance measurement.

Your convenience comes first

At Audi you can choose from a range of convenient services that suit your needs. Why not book a 'service while you wait' appointment* and enjoy our complimentary refreshments while your car is with us? Or, if you need to be mobile, take advantage of one of our courtesy cars which we can even deliver to you.* We guarantee we can service your Audi within 5 days without a courtesy car or within 10 days if you need transport. We will also ensure your car is returned to you with a full valet.

Audi Genuine Parts

You can rest assured that only Audi Genuine Parts will be used on your vehicle. What's more, Audi parts and labour come with a 2-year guarantee.**

No hidden costs

We believe strongly in transparency when it comes to our prices. For added peace of mind, we will give you a quotation over the phone for the work you have requested and email you the price confirmation. We'll consult you if any additional work on your car is needed when it is with us. We won't carry out any extra work without asking your permission first.

All part of the service

Whenever we see an Audi for a service, we connect it directly to our headquarters in Ingolstadt which enables us to check your car's software and make sure it's as up-to-date as possible. If the factory has released a software upgrade for your model, it can be applied immediately - improving anything from your car's efficiency to the precision of its parking system.

Audi Roadside Assistance

Your new car comes complete with 3 years' complimentary roadside assistance and recovery across the UK, provided by RAC Motoring Services. Also included is roadside assistance throughout Europe, managed by RAC Motoring Services.

For further information and terms and conditions please visit audi.co.uk.

* Subject to availability.

**Excludes wear and tear.



RS 6 Avant technical data

Engine	4.0 TFSI quattro
Transmission	8-speed tiptronic
Cylinder	V8
Displacement, cubic cm (valves per cylinder)	3993
Max. power ¹ , PS at rpm	560/5700-6600
Max. torque, Nm at rpm	700/1750-5500
Top speed, mph*	155
0-62mph acceleration, seconds	3.9
CO ₂ emissions ² , g/km	229
Benefit in kind (BIK) %	35%
Fuel consumption ² , mpg (l/100km) Urban	20.3 (13.9)
Fuel consumption ² , mpg (l/100km) Extra Urban	37.7 (7.5)
Fuel consumption ² , mpg (l/100km) Combined	28.8 (9.8)
ABI insurance group 1-50**	TBC
Unladen weight ³ , kg	1935
Gross weight limit, kg	2565
Roof load limit/ nose weight, kg	100/85
Max trailer load unbraked	750
Max load 12%	2100
Max load 8%	2100
Luggage compartment, seats upright, litres ⁴	565
Luggage compartment, seats folded, litres ⁴	1680
Fuel tank capacity approx, litres	75
Emission standard	EU5

*Electronically limited. Please see page 45 for option to increase limit.

**Highest insurance group rating shown. Group may be lower dependent on trim level. Please visit www.thatcham.org/wabigrouprating for details.

¹The given value was obtained in accordance with the specified measurement procedure (the respective current version of Directive 80/1269/EEC).

²Fuel consumption and CO₂ emissions figures are obtained under standardised test conditions (Directive 93/116/EEC) using a representative model. This allows direct comparison between different models from different manufacturers, but may not represent the actual fuel consumption achieved in 'real world' driving conditions. More information is available at www.vca.gov.uk.

³Vehicle's unladen weight without driver (calculated in accordance with the current version of Directive 92/21/EEC). The fitting of additional equipment may increase the vehicle's unladen weight and drag coefficient, whereupon the potential carrying capacity and top speed will be correspondingly reduced.

⁴Second value; loaded up to roof with rear seat folded down.



RS 6 Avant dimensions

The technical drawings opposite show the exact dimensions of the RS 6 Avant, so you can check everything – from whether the car will fit in your garage to whether your luggage will fit in the boot.

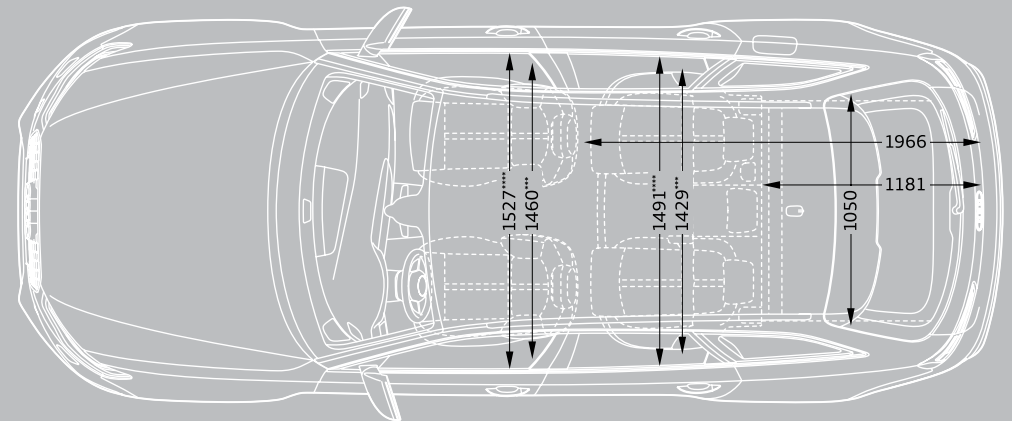
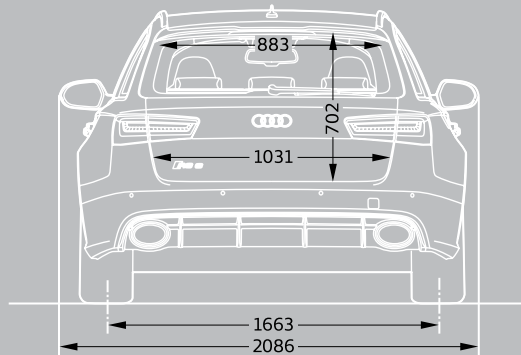
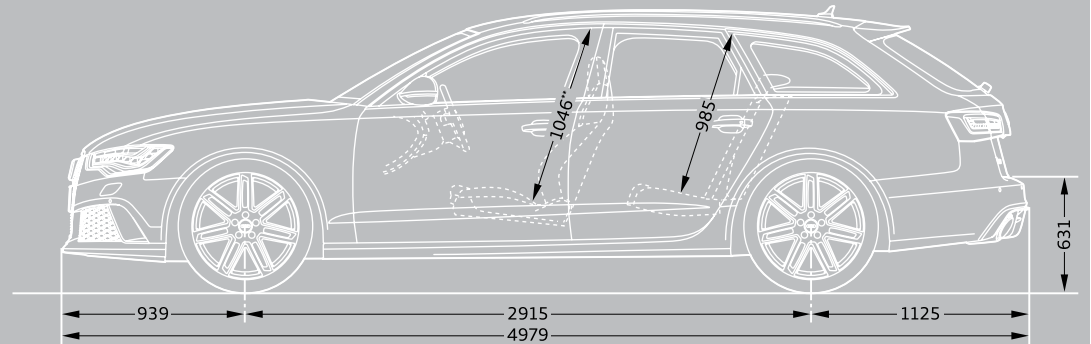
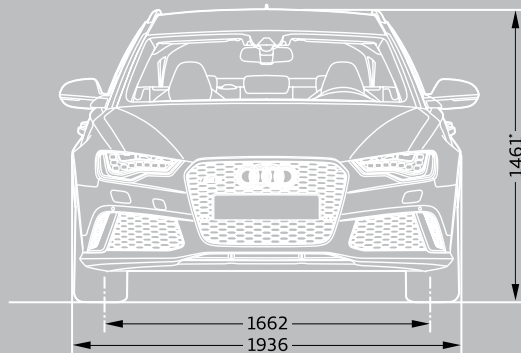

Dimensions in millimetres

*With roof aerial the height of the vehicle is 1,482mm

**Maximum headroom

***Shoulder width room

****Elbow width room

Dimensions were measured with vehicle at unladen weight, ground clearance measured with vehicle carrying its maximum load.

Luggage compartment volume in litres: 565/1,680 (measured by the VDA standard test method using 200 x 100 x 50mm blocks; second value: with rear seat folded down). Turning circle approx. 11.9m.

Pricing and Additional information

Welcome to Audi

By placing an order for your Audi, you're choosing to get behind the wheel of one of the most sophisticated cars on the road. And because we believe the service we offer should be just as advanced, we want to let you know exactly what you can expect from us, now and in the future.

We've agreed a set of standards with all our Centres which governs the way we do business with you. It outlines the kind of service we promise to deliver for every customer, right down to filling each new Audi we sell with half a tank of fuel.

So whether you're interested in the date your car will arrive in the UK or the way we'll dispose of non-biodegradable materials after we service your Audi, you can have total confidence in us.

Audi Promise

Audi Centres

We guarantee that all our Centres will be open as follows:

Sales: Monday to Friday 9am–6pm
Saturday 9am–5pm

Service: Monday to Friday 8am–6pm
Saturday 8.30am–1pm

Sunday opening is at local discretion.

New car delivery

Once we've confirmed a delivery date for your car, we'll keep you informed of progress. Subject to reasonable notice, we'll then deliver it to a place of your choice, whether that's your home or work. In the unlikely event of a delay, we'll provide a courtesy car to minimise inconvenience and keep you mobile.

Environmental commitment

We promise to dispose of all non-biodegradable materials from your vehicle in a responsible manner.

Pricing

Prices and specifications given are correct at the time of printing. Always check details with your Audi Centre as Audi policies are continually developing. We reserve the right to change prices or specifications at any time.

All prices are subject to VAT, currently charged at 20%, but this may alter to reflect any change in the applicable VAT rate.

Delivery charges and number plates are not included in the vehicle price.

Delivery charge	£471.66
Number plate	£20.00
VAT	£98.34
Total	£590.00

Audi Customer Care

Every new Audi benefits from the comprehensive Audi Customer Care Package, which comprises:

- ▶ A 3-year Audi warranty, which covers you for unlimited mileage in the first 2 years of ownership, with a full mechanical and electrical warranty which covers you for up to 60,000 miles in the 3rd year
- ▶ A 3-year paint warranty
- ▶ A 12-year anti-corrosion warranty
- ▶ 3 years' UK roadside assistance and recovery

You also have the option when ordering your new car of choosing a 4-year or 5-year Audi warranty. Speak to a member of the sales team for more information.

Audi tax-free sales

If you are entitled to purchase a vehicle free of VAT, normally through military or diplomatic privilege, please contact your local Audi Centre for full details.

Should you have any difficulty obtaining the information you require, please call Freephone 0800 585878.

Audi Finance

Audi Finance specialises in providing funding solutions for Audi drivers. Whether your Audi is for private or business use, there is a range of funding options to choose from.

Below is the full range of finance products, which comprises:

- ▶ Solutions – a Personal Contract Plan
- ▶ Hire purchase
- ▶ Lease purchase
- ▶ Finance lease
- ▶ Contract hire

With all products, you can choose a fixed-cost maintenance plan designed to help you budget accurately.

No matter which Audi model you choose, your local Audi Centre can provide you with a personalised quote designed to fit your budget and motoring needs.

Audi Finance is a trading name of Volkswagen Financial Services (UK) Limited. An offer of finance depends on certain conditions. Available to people over 18 in the UK only.

Audi Insurance

We want you to start enjoying your new car from day one and thanks to Audi Insurance complimentary 7-day cover, you can. Call free on 0800 316 7893 (lines are open Monday to Friday 8am–9pm, and Saturday 9am–5pm), provide a few details and a cover note will be sent to your Audi Centre. They will then tax your car and you can drive it away.

Additional information

CO₂ data and information

CO₂ emissions-based Vehicle Excise Duty

Vehicle Excise Duty (Road Fund Licence) is based upon the amount of Carbon Dioxide (CO₂) a vehicle emits, measured in grams per kilometre (g/km). First year VED rates apply to the first year of ownership. Annual VED rates apply thereafter. The DVLA has created thirteen categories:

Petrol and Diesel engines	First year	Annual rate (second year onwards)
A – up to 100g/km	£0.00	£0.00
B – 101 to 110g/km	£0.00	£20.00
C – 111 to 120g/km	£0.00	£30.00
D – 121 to 130g/km	£0.00	£105.00
E – 131 to 140g/km	£125.00	£125.00
F – 141 to 150g/km	£140.00	£140.00
G – 151 to 165g/km	£175.00	£175.00
H – 166 to 175g/km	£285.00	£200.00
I – 176 to 185g/km	£335.00	£220.00
J – 186 to 200g/km	£475.00	£260.00
K – 201 to 225g/km	£620.00	£280.00
L – 226 to 255g/km	£840.00	£475.00
M – over 255g/km	£1,065.00	£490.00

Vehicle Excise Duty (VED) rates correct at time of going to print, but these may alter to reflect any change in the applicable VED rate





Audi UK

Customer Services
Selectapost 29
Sheffield
S97 3FG
0800 699888
audi.co.uk

Specifications and prices subject
to change without notice.

© Audi UK

Printed in the UK
Edition 1.0 05/13
2014 model year

Images are for illustrative purposes only.