



**The Audi A6 allroad**  
Pricing and Specification Guide  
Valid from June 2015



# Personalising your Audi A6 allroad

This guide has been designed to help you tailor and price your Audi A6 allroad quickly and logically. At the back, you will find information on CO2 emissions-based taxation and the other services offered by Audi, including Finance and Insurance. You can also configure your Audi A6 allroad online at [audi.co.uk](http://audi.co.uk)



**Get more from this brochure with the free Audi Vision app.**

Audi Vision brings our brochures to life through Augmented Reality. It works by recognising images on a page through your device's camera. Suitable for phones or tablets, download it for free from the App Store or Google Play. Once downloaded, simply open the app and scan the cover of your guide. Then look out for any page with the Audi Vision logo, you can then hold your device over the page and watch as you get exclusive access to extra images, information and video content.



## The Audi A6 allroad

quattro®	8
Matrix LED lights Technology	10
Audi Connect	12
	14

## Model details and prices

Standard model equipment	16
Sport model equipment	18
Model prices	20

## Colour and upholstery

Paint	22
Upholstery	26
Seats	32
Colour and trim guide	33

## Inlays

## Options

Wheels and tyres	38
Packages	42
Headlights	45
Audio and communication	46
Interior equipment	48
Exterior equipment	49
Safety and security	50

## Looking after your Audi

Audi Complete and warranty	52
Accessories	55
Merchandise	56
Audi Difference	57

## Technical details

Technical data	58
Dimensions	59
Pricing and Additional information	60







## Vorsprung durch Technik

Three words that express the very essence of Audi. Vorsprung durch Technik isn't a slogan. It's our way of seeing the world. It is the driving force behind our history of innovation that continues into the 21st century. Indeed, many technologies that Audi pioneered remain in our cars today. Some are milestones in the history

of the motorcar. From our beginnings in 1899, to the Auto Union team's Grand Prix successes in the 1930s and our more recent wins at Le Mans, we have always been at the forefront of the motor industry.

Vorsprung durch Technik makes us who we are. To see more of its influence, just read on.

## The Audi A6 allroad

It's all in the name. The Audi A6 allroad is fit for all terrains – rugged or flat, town or country – thanks partly to the extraordinary road-holding of quattro® permanent all-wheel-drive. It maintains the car's traction when the conditions change, keeping you in control on the road. And, of course, off it.

Along with 18" alloy wheels and new, sharper, contoured headlights, the allroad incorporates some of our most luxurious interior features. And with the new Sport trim offering All-LED headlights, privacy glass and electrically adjustable front Sports seats, it's a range that's become even more dynamic.

The A6 allroad also includes a range of new and improved optional technologies designed to help you behind the wheel, like Matrix LED headlights which adapt automatically to the car's surroundings, Audi Connect that lets you and your passengers access the internet on the move and our top-of-the-range MMI Satellite Navigation which includes picture book navigation.







# quattro®

A heightened driving experience with ultimate control: it's what makes quattro® such a thrilling feature of the A6 allroad.

quattro® is Audi's intuitive all-wheel-drive system. Constantly analysing grip and distributing power to where it's needed most, the four permanently driven wheels deliver more responsive acceleration and assured grip on all surfaces.

And that's especially true when road conditions change. If one wheel loses traction, quattro® makes sure the others compensate to keep the car in control. Giving you a dynamic driving experience with superior handling – even in less than perfect driving conditions.

## **quattro® with Sports differential**

quattro® is fitted as standard on the A6 allroad and is available with Sports differential as an option that takes the driving dynamics to a whole new level, ensuring outstanding stability and superior acceleration performance.

By distributing torque variably to each of the rear wheels, the car steers even more spontaneously and directly. When cornering, for example, power is redirected to the outside rear wheel, literally pushing the car through the bend. Not only is acceleration more responsive, it requires less steering effort – for a more agile, enhanced drive.



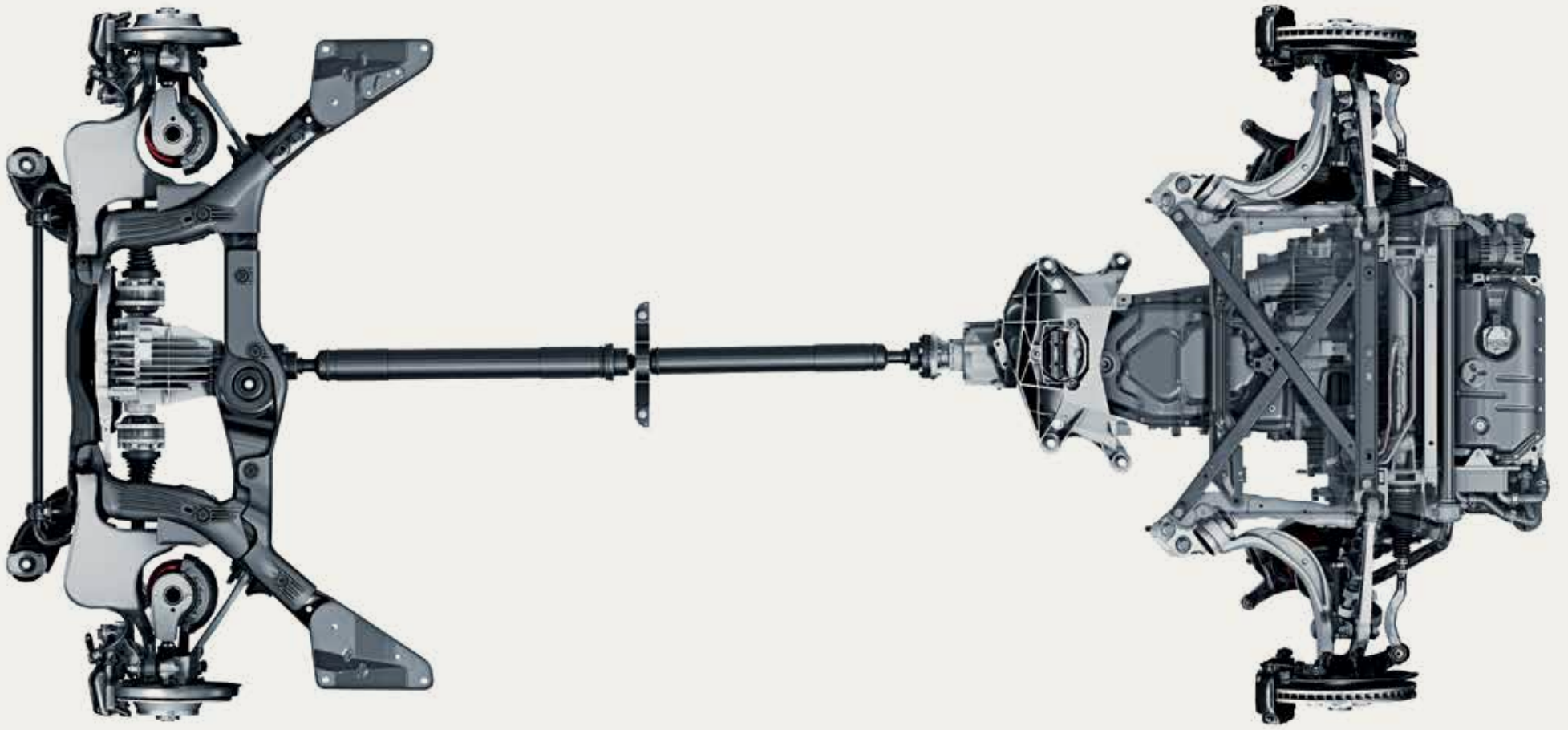



# Matrix LED lights

**That turn night  
into day.  
And more.**

Matrix LED headlights don't just produce a light that is similar in colour to daylight, they also incorporate remarkable technology that adapts automatically to the car's surroundings.

Available as an option on the A6 allroad range, sensors and an in-built camera allow Matrix LED headlights to detect near and oncoming lights of other road users, as well as ambient light in built-up areas. The technology then reacts by dipping individual LEDs to prevent dazzle, while still fully illuminating the remainder of the road.

Using the vehicle navigation data, Matrix LED technology can even anticipate corners, adjusting LEDs as you negotiate the bend. The result is a much wider visual range, benefiting both you and other road users. Dynamic sweeping indicators complete the striking look both at the front and rear.





# Technology

# Technology is advancing at an ever faster pace, and choosing the right technology for your car is an important decision.

Here at Audi, we strive to make that choice as easy as possible, so we have packaged some of our most popular equipment together for simplicity, but also added value. The most popular of which are our Technology Pack and Technology Pack Advanced, featuring our top-of-the-range HDD navigation and connectivity systems. For further details please see page 42.



## MMI Navigation Plus with MMI Touch

With HDD-based MMI Navigation plus with MMI Touch, you can let yourself be guided to your destination with even greater ease by the 8" display with 3D map view and 3D displays of places of interest and landmark buildings. Destinations can be entered via speech dialogue, the MMI rotor, or the MMI touchpad which recognises handwriting.



## Colour Driver's Information System (DIS)

A high resolution 7" colour display located in the instrument cluster provides key information from the driver assistance systems as well as the media in use, telephone menu, gear reference and outside temperature. The Colour DIS can also display information from optional equipment such as Night vision assistant and Audi lane assist.



## Audi Phone Box

The most convenient way to both use and charge your mobile phone, simply by placing it in the Audi Phone Box storage compartment in the front centre armrest. Audi Phone Box creates a 'wireless' connection to the car for improved reception quality, hands-free facility and voice control. Mobile phones can be charged via the USB port.



## Audi Side Assist

A clever assistance system for multi-lane roads which helps alert you to other vehicles in your blind spot when changing lanes. Using radar sensors discreetly hidden in the rear bumper, other vehicles are detected and the driver alerted with a visual warning signal in the door mirror.

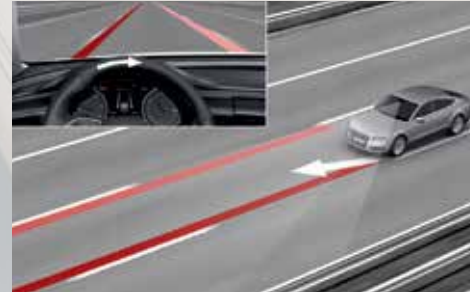

## Audi Active Lane Assist

An advanced Audi safety system which helps to keep you in lane by means of gentle steering intervention when lane boundary markings are detected. Particularly useful on long motorway journeys is the new active lane centring feature which gives steering assistance to keep your vehicle in the centre of the lane and enhance your driving comfort.



## Adaptive Cruise Control with Stop&Go

The Adaptive cruise control with Stop&Go featuring Pre-sense plus is the most innovative of Audi's driving assist systems. Vehicles ahead are detected by a radar sensor and the distance between the vehicles is kept more or less constant by automatic braking or accelerating. With Pre-sense plus, you add the ultimate in protection with enhanced brake assist functions which can detect and warn of imminent collision threats as well as initiate maximum braking to help avoid or minimise collisions if possible.



# Audi



## Wi-fi hotspot

Connects your mobile devices to the internet



## Email

Your emails can be transmitted to your Audi MMI and read out conveniently†



## Text messages

Messages are displayed or read out to you; you can also reply using the dictation function†



## Twitter

Enables you to tweet and receive updates on the move. With text-to-speech and other convenient text functions



## Weather information

Gives you forecasts and maps for your chosen destination



## News online (individual)

Text and images from your favourite news sources with text-to-speech function



## Map update online

The map version delivered can be updated free of charge with the first 5 navigation updates which are issued at intervals of 6 months. In conjunction with Audi Connect, the update can be carried out online in the vehicle



## City events

Up-to-date information about events happening at your destination



## Points of interest

Search Google™ using voice control



## Traffic information online

Complements the dynamic route guidance with real-time traffic flow information for individual stretches of road



## myAudi – special destinations

Import individual point-of-interest (POI) lists to your satellite navigation system via the myAudi portal



## Train information

Find departure and arrival times and platform information while you're on the road (also available for other types of public transport such as underground systems)



## Picturebook navigation

Uses GPS data from your photos to get you to your destination



## Country specific information

The legal regulations for a specific country, such as speed limits or whether it is compulsory to carry a high-visibility vest or display a motorway toll sticker, are displayed when crossing a border



## Fuel prices

Information on filling stations with the cheapest prices in your selected search area



## Parking information

Helps you find car parks nearby and, where available, information on prices and currently vacant spaces



## Flight information

Get information about departure and arrival times as well as the corresponding gates and search directly for flight numbers



## Access smartphone voice control

Such as Siri (iPhone 4S and higher). By pressing and holding the voice control button on the multi-function leather steering wheel you can access the voice control function of the Bluetooth-connected smartphone directly even while driving



## Navigate with Google Earth™ and Google Street View™

Uses high-resolution aerial and satellite images as well as photos to guide you to your destination with ease





# Connect



## Stay networked on the move.

Being inside your car shouldn't mean losing touch with the outside world. That's why, with Audi Connect, the A6 allroad creates a link between you and the internet.

With high-speed, 4G internet access in your car, you can go online to access information, entertainment and Google Earth navigation maps by scrolling, tapping or speaking your commands. Audi Connect can even read aloud your text messages and allows you to dictate a response. And, with a wireless hotspot within the car, passengers can connect up to 8 mobile devices – to browse the internet, download emails, or access social media.

With Audi Connect, the world is at your fingertips.

Please note that an external data source is required to enable Audi Connect online services. Terms and conditions apply to certain Audi Connect functions. Please see page 61 for additional information.  
\*Only available if your mobile phone has the Bluetooth profile MAP (Message Access Profile).

# Standard model equipment

All A6 allroad models have the following items of standard equipment

## Engine and transmission

Automatic start-stop system with energy recuperation

**Efficiency programme** – the Driver's Information System (DIS) comes with an efficiency programme which offers up-to-the-minute advice on ways to help improve fuel economy as you drive

**Recuperation** – the kinetic energy produced from braking or coasting is converted into electrical energy and stored temporarily in the battery. When accelerating, this energy is used, relieving the load on the alternator – this can result in a fuel saving of up to 3%

## Wheels, tyres and suspension

18" x 8J '5-arm' design alloy wheels with 235/55 R18 tyres

**Adaptive air suspension** – the driver can choose between automatic suspension and three further suspension settings which are accessed via the MMI: Comfort, Dynamic and Lift

**Audi drive select** – with four pre-configured modes (Comfort, Auto, Dynamic and Efficiency), and a further Individual mode allowing the driver to electronically adjust the engine, transmission and steering

**Collapsible spare wheel**

## Lighting

**Bi-Xenon headlights.** Xenon lights for full and dipped beam headlights, includes LED daytime running lights

**LED rear lights**

**Headlight washer system**

## Audio and communication

**MMI Navigation (SD card based)** – including 6.5" MMI colour display with high quality map display, voice control using whole words, dynamic route guidance, additional arrow display in Driver's Information System (DIS)

**Mobile telephone preparation – Bluetooth**

**Audi Music Interface** – Universal connection for use with stereo audio sources, USB and MP3 devices including Apple iPod generation 4 onwards (iPod, iPod classic, iPod mini, iPod nano, iPod photo, iPod video, iPod touch). The interface provides charging function (dependent on device)

**MMI Radio Plus and DAB** – including:

- 2 x SDHC memory card readers (up to 32GB)
- Single CD player and memory card reader that supports MP3, WMA and AA
- TP memo – automatically saves traffic news when driving

**Driver's Information System (DIS)** –

monochrome display in the instrument cluster. The DIS shows the radio frequency/station or the song title, outside temperature, trip computer, gear-shift display, telephone menu and a rest recommendation feature which visually and acoustically alerts the driver to take a break when getting tired

**Audi Sound System**

- 6 channel amplifier
- 180 Watt amplifying capacity
- 10 loud speakers including subwoofer located in spare wheel well



18" x 8J '5-arm' design alloy wheels



Bi-Xenon all-weather headlights – with LED daytime-running lights

## Exterior equipment

**Exterior mirrors** – electrically adjustable and heated

**Power-operated tailgate** – opening via the remote control key, and when ordered in combination with the Advanced key (PG3) the tailgate will also close remotely. Opening and closing is also possible using the button in the driver's door panel or the soft touch button on the tailgate.

Includes a programmable tailgate opening angle and electrically operated luggage area cover. When the tailgate is opened the luggage cover is automatically drawn back along its rails and then returns when the tailgate is closed

**Tow bar bracket preparation** – the set of parts for retrofitting is available from Audi Accessories (see page 55) or available as an option (see page 49)

**Aluminium optic package** comprising:

- Aluminium roof rails
- Window capping strips in aluminium
- Door handles with aluminium-look trim

**Body-coloured roof spoiler**

**Body-coloured door mirrors**

## Safety and security

**Electronic Stability Control (ESC)**

**6 airbags**

- Front airbags
- Front side airbags
- Curtain airbags

**Seat belt monitoring**

**Anti-theft alarm**

## Assistance systems

**Audi parking system plus** – acoustic and visual park assist system for the front and rear

**Cruise control**

**Light and rain sensor**

**Tyre pressure loss indicator**

**Hill descent control with Hill hold assist**

**Electromechanical parking brake**

**Keyless go** – conveniently allows the engine to be started by simply pressing the start-stop button in the centre console. The key just needs to be carried

## Interior equipment

**Deluxe 4-zone automatic air conditioning**

**3-spoke leather trimmed multi-function steering wheel with paddles**

**Auto-dimming rear-view mirror**

**Aluminium delta inlays**

**Aluminium door sill trims with allroad logo**

**Storage pack** comprising:

- 2 x drinks holders in the rear centre armrest
- 2 x 12-Volt sockets in the rear
- Luggage net

**Front centre armrest**

**Front and rear floor mats in black velour**

**Cloth headlining**

**Luggage compartment system** comprising:

- Rail luggage fixing system
- Dirt-resistant tray
- Double cargo floor
- Lashing points, side restraining straps and bag hooks

## Seats

**Standard seats in Milano leather upholstery** – Includes manual adjustment for seat height, length, backrest angle, head restraint and belt height

**Split-folding rear seat backs**

**ISOFIX Child seat mounting** – for front passenger (with airbag deactivation) and outer rear seats. Including Top Tether attachment point for the outer rear seats



3-spoke leather trimmed multi-function steering wheel



Aluminium door sill trims with allroad logo



# Sport model equipment

In addition to Standard model equipment

**Total RRP inc VAT**  
£3,700.00

## Wheels, tyres and suspension

19" x 8.5J '10-spoke' design alloy wheels in matt titanium look, gloss turned finish with 255/45 R19 tyres

## Lighting

All-LED headlights including high-beam assist. LEDs for all front lighting functions. LED technology provides lower energy consumption and enhanced contrast with a colour similar to daylight, for increased safety and good recognition by other road users. Includes all-weather light function to reduce the risk of the driver being dazzled when visibility is poor (in fog, rain or snow). Also includes high-beam assist which automatically adjusts headlights from high-beam to dipped-beam when another vehicle is approaching or when other ambient lighting is detected (i.e. street lights) by a camera on the interior mirror

Dynamic rear LED indicators – dynamically sweep from inside to out within 0.15 seconds. This helps to clearly identify not only that the vehicle is turning but in which direction – increasing road safety as it is easier for other road users to determine which way cars are moving in a shorter amount of time

## Exterior equipment

Exterior mirrors – heated, electrically adjustable, electrically folding, automatic kerb view function which tilts the passenger mirror downwards towards the kerb when reverse gear is engaged and with memory function

Privacy glass. Dark tinted rear and rear-side windows (from B-pillar backwards)

## Interior equipment

Electrically adjustable front Sports seats including electrically adjustable 4 way lumbar support – including:

- Forwards/backwards position
- Seat height and angle
- Backrest angle
- Memory function for driver's side

Upholstery in black Valcona leather

Door trim inserts in Alcantara upholstery



19" x 8.5J '10-spoke' design alloy wheels in matt titanium look, gloss turned finish



All-LED headlights including high-beam assist



Image shows A6 allroad Sport with optional Mythos black, metallic paint (0E)

## A6 allroad

Engines	Power	Transmissions	CO <sub>2</sub> g/km	Total RRP inc VAT	Recommended OTR
3.0 TDI quattro	218PS	7-speed S tronic	149	£44,925.00	£45,755.00
3.0 TDI quattro	272PS	7-speed S tronic	149	£46,485.00	£47,315.00
3.0 BiTDI quattro	320PS	8-speed tiptronic	172	£51,145.00	£52,125.00

## A6 allroad Sport

Engines	Power	Transmissions	CO <sub>2</sub> g/km	Total RRP inc VAT	Recommended OTR
3.0 TDI quattro	218PS	7-speed S tronic	149	£48,625.00	£49,455.00
3.0 TDI quattro	272PS	7-speed S tronic	149	£50,185.00	£51,015.00
3.0 BiTDI quattro	320PS	8-speed tiptronic	172	£54,845.00	£55,825.00

**Please note:** The maximum power output figures are quoted in PS (or Pferdestärke, which is the metric equivalent of brake horsepower). To convert to brake horsepower, divide the PS figure by 1.0139.

**Recommended On-The-Road (OTR) retail prices include:** delivery charge, half a tank of fuel, number plates at £630.00 (inc. VAT), Road Fund Licence (which may vary depending on model/transmission – see page 61 for details) and first registration fee at £55.00. Vehicle Excise Duty correct at time of going to print, but this may alter to reflect any change in the applicable VED rate.

RRP – Recommended Retail Price. VAT is calculated at 20% but this may alter to reflect any change in the applicable VAT rate.







# Paint

We believe that every part of your car should have a personal touch – which is why you can choose from a wide range of paint colours and finishes, from standard shades to metallic and pearl effects. We can even mix a customised colour for you to create the perfect fit.

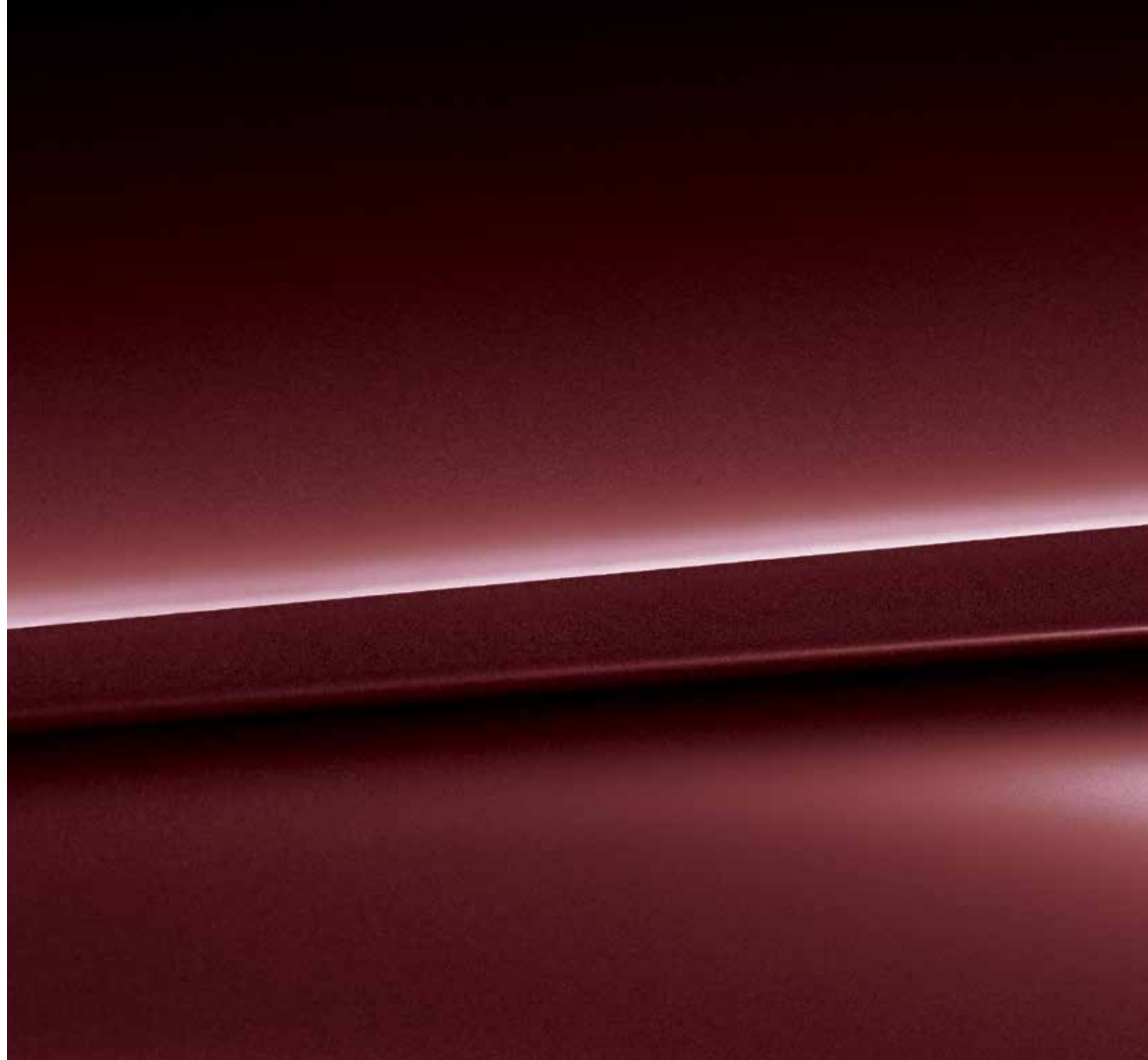

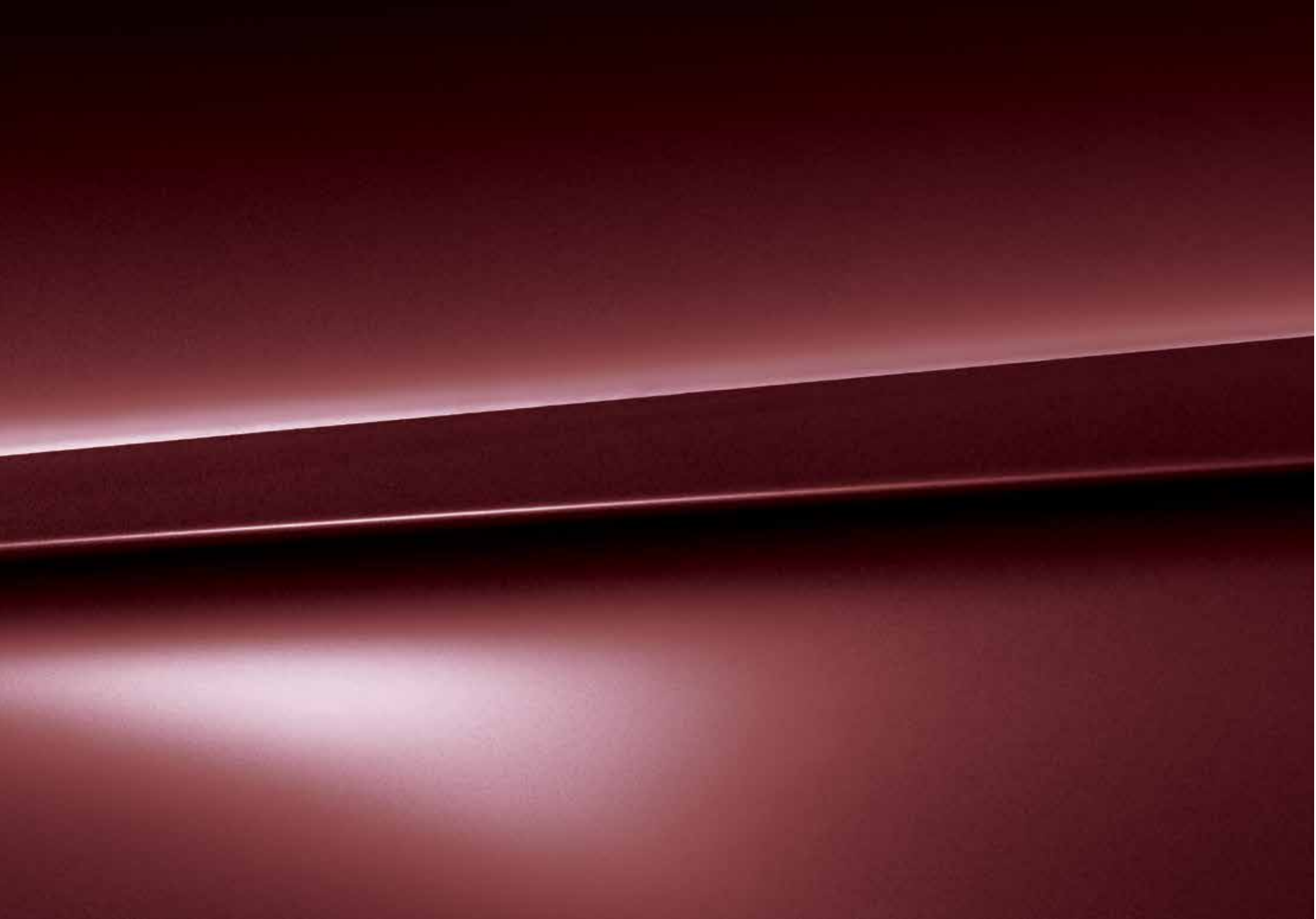



# Paint

## Standard and optional colours

You can select one of the standard colours shown opposite or, for a different look, choose from a range of optional finishes.

Options are subject to availability and may extend delivery.

All the colour swatches on this page are matched as accurately as possible to the actual paint colours used. However, due to print processes, Audi UK cannot guarantee that colours shown are 100% accurate.

Visit your local Audi Centre for a more accurate colour swatch.

Please note all exterior colours come with Anthracite metallic contrast bumpers however Floret Silver, Dakota grey, Tornado grey, Diamond beige, Garnet red and Audi exclusive colours come with matt black contrast bumpers.

\*These colours are not available in combination with full paint finish.

RRP – Recommended Retail Price.

VAT is calculated at 20% but this may alter to reflect any change in the applicable VAT rate.

### Standard colours



Ibis white – T9\*

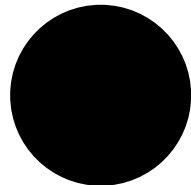

Brilliant black – A2\*

### Optional colours

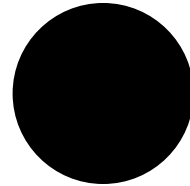

Mythos black, metallic – 0E

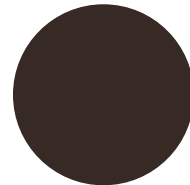

Java brown, metallic – 0Y

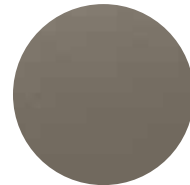

Diamond beige, metallic – N3\*

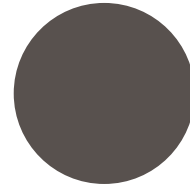

Dakota grey, metallic – Y7

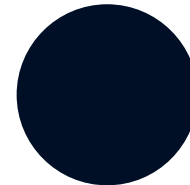

Moonlight blue, metallic – W1

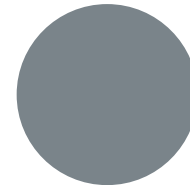

Tornado grey, metallic – Q2

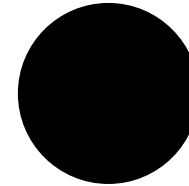

Havannah black, metallic – 4J

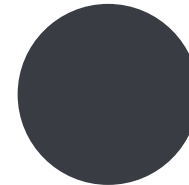

Oolong grey, metallic – 4N

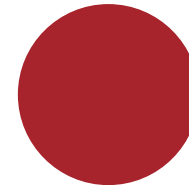

Garnet red, pearl effect – 9C\*



Glacier white, metallic – 2Y

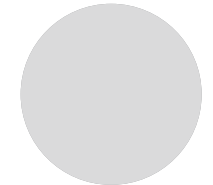

Floret silver, metallic – L5

### Optional colours

**Total RRP inc VAT**  
£675.00

# Paint

## Audi exclusive

Everyone has a favourite colour. No matter what yours is, Audi exclusive provides a range of unique colours that have been designed to set your car apart. Choose from the swatches here, or specify any other paint colour in the Audi range. The choice is yours.\*

## Customised

If you have a particular colour in mind, we'll mix the exact metallic or pearl-effect shade you want.\*\*

Options are subject to availability and may extend delivery.

Audi exclusive paints are not available in combination with full paint finish.

\*Audi exclusive paint is subject to factory approval. Visit your local Audi Centre for colour samples.

\*\*Customised paint is subject to factory approval, and is available for metallic and pearl-effect water-based paints only. Three-colour process colours and two-tone schemes are not available.

All the colour swatches on this page are matched as accurately as possible to the actual paint colours used. However, due to print processes, Audi UK cannot guarantee that colours shown are 100% accurate.

Visit your local Audi Centre for a more accurate colour swatch.

RRP – Recommended Retail Price.

VAT is calculated at 20% but this may alter to reflect any change in the applicable VAT rate.

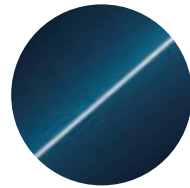

Palace blue, pearl effect

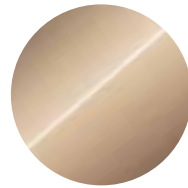

Sand beige, pearl effect

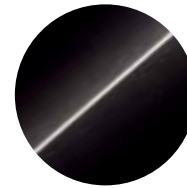

Saddle brown, pearl effect

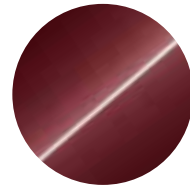

Classic red, pearl effect

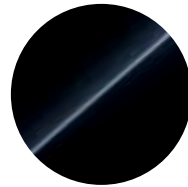

Mamba black, metallic

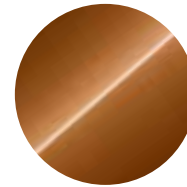

Ipanema brown, metallic



Any colour in the Audi range or 100 exclusive colours to choose from\*

**Audi exclusive\***

**Total RRP inc VAT**  
£2,155.00



Customised paint\*\*

**Customised\*\***

**Total RRP inc VAT**  
£2,655.00

## Upholstery

It's important to feel comfortable on the road. Just choose from our range of luxury upholstery materials and textures, including additional support and colour options, for complete relaxation while you drive.







# Upholstery

## Standard seats

Standard seats are manually adjustable for head restraint height or clearance, belt height, backrest angle, seat height and forwards and backwards seat position. To further enhance your comfort you can also add electric lumbar support and seat heating.

Choose your favourite seat and upholstery to give your car's interior the look and feel you want.

Options are subject to availability and may extend delivery.

- = Not available
- = Available
- S = Standard

All leather upholstery choices include seats, head restraints and front centre armrest in leather.

RRP - Recommended Retail Price.

VAT is calculated at 20% but this may alter to reflect any change in the applicable VAT rate.

Milano leather  
- NSW

 <p>Black - FZ</p>	A6 allroad	A6 allroad Sport	<b>Total RRP inc VAT</b>
S	-	-	No charge

**Milano leather.** Seat covers, head restraints and front centre armrest in Milano leather, which is fully penetrated with dye and lacquered for excellent surface protection. The leather is extremely hard-wearing and durable, tanned without using chromium and gives a high-quality impression with its fine-grained surface

# Upholstery

## Front Sports seats – PS1

Front Sports seats include 4-way electric lumbar support and manual height adjustment.

			A6 allroad	A6 allroad Sport	Total RRP inc VAT
Milano leather – N5W		Black – VV	•	–	£665.00
Leather/Alcantara – N7U		Black – FZ	•	–	£665.00
			–	•	No charge
Valcona leather – N5D		Santos brown – VT	•	S	£1,165.00
		Black – VV			
		Atlas beige – WO			

Options are subject to availability and may extend delivery.

- = Not available
- = Available
- S = Standard

All leather upholstery choices include seats, head restraints and front centre armrest in leather.

RRP – Recommended Retail Price.

VAT is calculated at 20% but this may alter to reflect any change in the applicable VAT rate.



# Upholstery

## Comfort seats – PS8

Comfort seats offer a multitude of electrical or pneumatic adjustment options with memory function for both front seats and must be combined with Exterior mirrors (6XF/6XL).

Electrically adjustable:

- Backrest angle, seat height, seat rake, forward and backward position and thigh support

Manually adjustable:

- Head restraint height/clearance and belt height

Pneumatically adjustable:

- Lumbar support, backrest side sections and seat-side sections

Options are subject to availability and may extend delivery.

- = Not available
- = Available
- S = Standard

RRP – Recommended Retail Price.

VAT is calculated at 20% but this may alter to reflect any change in the applicable VAT rate.

Valcona leather  
– NSD



Black – FZ

Atlas beige – IV

Santos brown – VY

**Valcona leather.** Seat covers, head restraints, door trims and front centre armrest in Valcona leather, a high-quality material which contributes to the elegance of the interior. A lacquered surface allows the material to breathe whilst the non-grained surface underlines the luxury of the A6 allroad. Valcona leather is tanned without using chromium, dyed and uses non-fading colour pigments

A6 allroad	A6 allroad Sport	Total RRP inc VAT
•	-	£2,500.00

# Upholstery

## Audi design selection

The Audi design selection includes some of our most striking design features, all of which have been selected by our experts. And because this package is exclusively available with the A6 allroad, it promises to give your car a look that's as unique as it is sophisticated.

Order Code	A6 allroad	A6 allroad Sport	Total RRP inc VAT
<b>PEX</b> <b>PS8</b> <b>N5D</b> <b>7HE</b> <b>6RB</b>	●	—	£5,500.00

**Audi design selection Flint grey package includes:**

- Front Comfort seats (PS8) in Flint grey Valcona leather (N5D) with contrasting stitching in Brass
- Front centre armrest in Flint grey Valcona leather with contrast stitching in Brass
- Door armrests (7HE) and lower part of the centre console in Flint grey leather with contrast stitching in Brass
- Door trim inserts in Flint grey Alcantara
- Upper part of the dashboard in Granite grey
- Lower part of the dashboard in Flint grey
- Steering wheel in Granite grey
- Inlays in Fine grain ash, natural brass (no alternative inlay available)
- Flint grey velour floor mats with contrast stitching in Brass

Must be combined with Exterior mirrors (6XF/6XL)

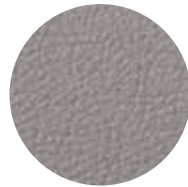

Flint grey  
Valcona leather - WI



Fine grain ash,  
natural brass inlays



Door armrests in Flint grey leather with contrast stitching in Brass



Inlays in Fine grain ash, natural brass



Front comfort seats in Flint grey Valcona leather

Options are subject to availability and may extend delivery.

— = Not available  
 ● = Available  
 S = Standard

RRP – Recommended Retail Price.

VAT is calculated at 20% but this may alter to reflect any change in the applicable VAT rate.

# Seats

Choose from a variety of different seat options so you can maintain the correct driving posture at all times.

Order Code		A6 allroad	A6 allroad Sport	Total RRP inc VAT
4A3	<b>Heated front seats.</b> Individually controlled variable temperature adjustment. Only available in combination with lumbar support (7P1)	●	●	£320.00
4A4	<b>Heated front and outer rear seats.</b> Individually controlled variable temperature adjustment. Only available in combination with lumbar support (7P1)	●	●	£660.00
7P1	<b>Electric lumbar support.</b> For front seats with horizontal and vertical adjustment	●	S	£295.00
PV3	<b>Electric front seats with driver's seat memory.</b> Electrical adjustment for seat forwards and backwards position, seat height, angle and backrest angle adjustment, 4-way lumbar support, driver's seat with memory function. Only available in combination with Exterior mirrors with memory function (6XL or 6XF). Not available in combination with Comfort seats (PS8)	●	S	£950.00
4D3	<b>Seat ventilation for front seats.</b> 3 different intensities of cool air drawn through the seat for active ventilation of the seat-centre section and thigh support. To allow for the seat ventilation, the leather of the seat front is perforated. Only in combination with Seat heating (4A3 or 4A4). In combination with standard seats must be combined with Electrically adjustable front seats (PV3). Not available in combination with Front Sports seats (PS1)	●	—	£840.00
4D8	<b>Massage and seat ventilation for front seats.</b> Massage function with 5 different programmes (wave, pulse, stretch, lumbar, shoulders) and 5 levels of intensity for massaging the muscles with the help of 10 pneumatic cushions. Ventilation with 3 different intensities of cool air drawn through the seat for active ventilation of the seat-centre section and thigh support. To allow for the seat ventilation, the leather of the seat front is perforated. Only available in combination with Comfort seats (PS8) and with Seat heating (4A3 or 4A4)	●	—	£1,600.00

Options are subject to availability and may extend delivery.

- = Not available
- = Available
- S = Standard

\*This image illustrates the seat only. For colour choices please refer to the swatches.

RRP – Recommended Retail Price.

VAT is calculated at 20% but this may alter to reflect any change in the applicable VAT rate.



Standard seat with optional 4-way electric lumbar support



Comfort seat\*



Front Sports seat

# Colour and trim guide

## Interior trim colours

### Standard seats

To help you choose the right interior for your new Audi A6 allroad, please use this guide, showing the carpet, dashboard and headlining colours that have been matched to your chosen upholstery.

### Sports seats – PS1

### Comfort seats – PS8

Options are subject to availability and may extend delivery.

- = Not available
- = Available
- S = Standard

Order Code	Upholstery (seat centre/seat bolster)	Carpet	Dashboard (upper/lower)	Headlining	Milano leather (N5W)
<b>FZ</b>	Black/Black	Black	Black/Black	Lunar silver	•

Order Code	Upholstery (seat centre/seat bolster/stitching)	Carpet	Dashboard (upper/lower)	Headlining	Milano leather (N5W)	Leather/Alcantara (N7U)	Valcona leather (N5D)
<b>FZ</b>	Black/Black	Black	Black/Black	Lunar silver	-	•	-
<b>VV</b>	Black/Black/Santos brown	Black	Black/Black	Lunar silver	•	-	•
<b>VT</b>	Santos brown/Santos brown/Anthracite	Black	Black/Black	Lunar silver	-	-	•
<b>WO</b>	Atlas beige/Atlas beige/Agate grey	Black	Black/Black	Atlas beige	-	-	•

Order Code	Upholstery (seat centre/seat bolster/stitching)	Carpet	Dashboard (upper/lower)	Headlining	Valcona leather (N5D)
<b>FZ</b>	Black/Black	Black	Black/Black	Lunar silver	•
<b>VY</b>	Santos brown/Santos brown	Black	Black/Black	Lunar silver	•
<b>IV</b>	Atlas beige/Atlas beige	Black	Black/Black	Atlas beige	•
<b>WI</b>	Flint grey/Brass	Flint grey	Granite grey/Flint grey	Lunar silver	•



## Inlays

Attention to detail can make a big impact. From contemporary Piano black finish to a Walnut brown, our selection of inlays offers the perfect finishing touch to your car's interior.







# Inlays

Inlays are the all-important finishing touch that add flair and interest to your car's interior.

Order Code		A6 allroad	A6 allroad Sport	Total RRP inc VAT
7TH	<b>Aluminium delta</b>	S	S	No charge
5MG	<b>Walnut, dark brown.</b> Covers centre console, door trims and the continuous inlay seam, with aluminium-look edging	●	●	£385.00
5TD*	<b>Bronze aluminium delta.</b> Covers centre console, door trims and the continuous inlay seam, with aluminium-look edging	●	●	£385.00
7TD	<b>Beaufort walnut.</b> Covers centre console, door trims and the continuous inlay seam, with aluminium-look edging	●	●	£650.00
7TL	<b>Fine grain ash, natural brown.</b> Covers centre console, door trims and the continuous inlay seam, with aluminium-look edging	●	●	£385.00
5TL	<b>Piano finish, black.</b> Covers centre console, door trims and the continuous inlay seam, with aluminium-look edging	●	●	£700.00
5TB	<b>Aluminium, beaufort black.</b> Covers centre console, door trims and the continuous inlay seam, with aluminium-look edging	●	●	£1,550.00

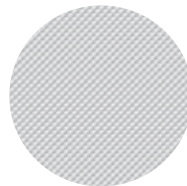

Aluminium delta – 7TH



Walnut, dark brown – 5MG

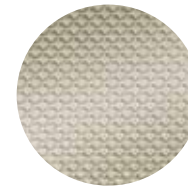

Bronze aluminium delta – 5TD\*



Beaufort walnut – 7TD



Fine grain ash, natural brown – 7TL

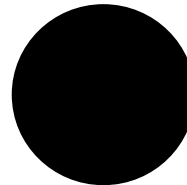

Piano finish, black – 5TL



Aluminium, beaufort black – 5TB



Fine grain ash, natural brass†

Options are subject to availability and may extend delivery.

- = Not available  
● = Available  
S = Standard

\*Only available in combination with Atlas beige or Santos brown interior.

†Only available as part of Audi design selection, flint grey (PEX) please refer to page 31 for more details.

RRP – Recommended Retail Price.

VAT is calculated at 20% but this may alter to reflect any change in the applicable VAT rate.

# Inlays

## Audi exclusive

Audi exclusive has sourced a wide range of materials from which you can select for your inlays, from Oak sepia to Fine grain myrtle.

Order Code		A6 allroad	A6 allroad Sport	Total RRP inc VAT
YTA S3G	Audi exclusive inlays (cannot be combined with the inlays shown on page 36)	●	●	£1,365.00



Tamo ash, natural dark brown



Modrone wood, gold

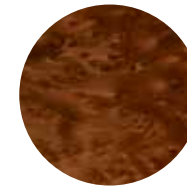

Vavona wood, bronze



Fine grain ash, nougat



Fine grain myrtle, nutmeg



Oak, sepia

Options are subject to availability and may extend delivery.

- = Not available
- = Available
- S = Standard

RRP - Recommended Retail Price.

VAT is calculated at 20% but this may alter to reflect any change in the applicable VAT rate.



## Options

Every driver has different needs, which is why we have created some useful options to further enhance your car. For extra comfort, support, style or function, you can choose from a variety of additional features, tailoring everything from your infotainment and audio equipment to your wheels and lighting.





# Wheels and tyres

Choose a set of specially selected alloy wheels to subtly enhance the way your car looks and drives.

Order Code		A6 allroad	A6 allroad Sport	Total RRP inc VAT
<b>C1Q</b>	<b>18" x 8J '5-arm' design alloy wheels with 235/55 R18 tyres</b>	S	—	No charge
<b>PRK</b>	<b>19" x 8.5J '10-spoke' design alloy wheels with 255/45 R19 tyres</b>	●	—	£1,200.00
<b>PQ9</b>	<b>19" x 8.5J '10-spoke' design matt titanium look, gloss turned alloy wheels with 255/45 R19 tyres</b>	—	●	No charge
<b>PRP</b>	<b>20" x 8.5J '5-parallel-spoke' design alloy wheels with 255/40 R20 tyres</b>	●	—	£2,300.00
		—	●	£430.00
<b>PQJ</b>	<b>20" x 8.5J '5-twin-spoke' design alloy wheels in matt titanium look, gloss turned finish with 255/40 R20 tyres</b>	●	—	£2,500.00
		—	●	£630.00
<b>GH2</b>	<b>quattro with Sports differential.</b> The electronically regulated Sports differential distributes variable amounts of driving force to each rear wheel, ensuring outstanding acceleration performance in corners and stabilising the vehicle's response to load change. It also ensures better direct steering characteristics and, thanks to less steering effort, more agile handling	●	●	£1,100.00
<b>1N8</b>	<b>Dynamic steering.</b> Improves comfort and handling by dynamically regulating steering according to the driving situation. With this technology, driving is significantly more agile under everyday conditions, while directional stability and precision are increased at high speeds and in demanding driving situations	●	●	£1,210.00



18" x 8J '5-arm' design alloy wheels – C1Q



19" x 8.5J '10-spoke' design alloy wheels – PRK



19" x 8.5J '10-spoke' design matt titanium look, gloss turned alloy wheels – PQ9



20" x 8.5J '5-parallel-spoke' design alloy wheels – PRP



20" x 8.5J '5-twin-spoke' design alloy wheels in matt titanium look, gloss turned finished – PQJ

Options are subject to availability and may extend delivery.

● = Available  
 – = Not available  
 S = Standard

RRP – Recommended Retail Price.

VAT is calculated at 20% but this may alter to reflect any change in the applicable VAT rate.







# Packages

Some items work well together, which is why we've created these special packages. They provide increased convenience and value by combining several of our most popular options.

The drivers assistance systems featured on these pages work only within system limits. They assist the driver with driving tasks. However, the driver remains responsible for driving the vehicle and is required to be attentive.

For more information regarding the individual items within these Technology packs please refer to pages 12-15.

Options are subject to availability and may extend delivery.

- = Not available  
• = Available  
S = Standard

\*Where the law permits.

RRP - Recommended Retail Price.

VAT is calculated at 20% but this may alter to reflect any change in the applicable VAT rate.

Order Code		A6 allroad	A6 allroad Sport	Total RRP inc VAT
WB4	<p><b>Technology Pack.</b> Featuring the top-of-the-range navigation and connectivity systems</p> <p><b>MMI Navigation Plus with MMI Touch.</b> Includes HDD-based navigation with topographical map display, places of interest and townmodels in 3D. Destinations can be entered via the speech dialogue system or MMI touch. Also includes 8" display, DVD player and 2 SDXC memory card readers</p> <p><b>Driver's Information System (DIS) with 7" colour display.</b> High-resolution TFT colour 7" display in direct field of view of the driver. Shows information from driver assistance systems, media in use, telephone menu, gear, outside temperature and other display content of the MMI such as Night vision assistant (if optionally selected)</p> <p><b>Audi Connect and Audi Phone Box.</b> Audi Connect provides access to a number of innovative online services including: navigation using Google Earth™ images and Google Street View™, destination entry via Google Maps™ or myAudi, online point of interest search and information services such as weather forecasts and the latest world news. Audi Connect can also create a Wi-fi hotspot in the car for convenient internet access using a mobile device (e.g. laptop or tablet). Audi Phone Box enables drivers to use their mobile phone in the car by placing it in the storage compartment provided in the centre console to create a 'wireless' connection to the vehicle aerial. Operated via the MMI control panel or the multifunction steering wheel. Mobile phone can be charged via a USB port</p>	•	•	£1,625.00
	<p><b>Technology Pack Advanced.</b> Features all the content of the Technology pack and adds our latest driver assistance systems for the ultimate innovation</p> <p><b>Audi adaptive cruise control with Stop&amp;Go function including Pre-sense front.</b> Automatic distance regulation, using radar sensors to maintain the required distance between vehicles by braking and accelerating. Works at speeds between 0 and 150mph.* Also includes Audi braking guard - a system which triggers a visual and acoustic alarm when it detects the risk of a rear end collision with the vehicle in front. In addition, the airbags are preconditioned if a crash is sensed and the system is prepared to assist with necessary braking force once the brake pedal is touched</p>	•	-	£3,500.00
WB7 PCN	<p><b>Audi side assist including Pre-sense rear.</b> Aids the driver when changing lane. The system monitors the area behind the car, using radar sensors located discreetly in the rear bumper, informing the driver with a visual warning signal in the door mirror if there is a vehicle in their blind spot or approaching quickly from behind. In combination with Audi active lane assist there is a noticeable steering intervention before veering out of the lane if a lane change is judged to be hazardous due to an approaching vehicle. The steering intervention only occurs if both systems have been activated and ready (works at speeds above approximately 37mph)</p> <p><b>Audi lane assist.</b> Helps the driver to stay in lane with gentle steering impulses for greater safety and convenience</p> <p><b>Exterior mirrors (6XE).</b> Heated, electrically adjustable and electrically folding with automatic kerb view function which tilts the passenger mirror downwards towards the kerb when reverse gear is engaged. A6 allroad Sport includes exterior mirrors with memory function (6XF)</p>	-	•	£3,265.00

# Packages

Order Code		A6 allroad	A6 allroad Sport	Total RRP inc VAT
WC9	<b>Parking Pack.</b> Offers state-of-the-art parking systems for easy parking - Park assist helps identify suitable parking spaces before enabling an effortless manoeuvre into them – you simply accelerate and brake while the vehicle automatically steers - Additionally, a rear camera provides imagery with guidelines to ensure easy reverse parking	●	●	£810.00
WF5	<b>Parking Pack Advanced.</b> Features all the content of the Parking Pack and adds the innovative Top View image for the ultimate luxury in parking systems - In addition to the benefits of the Parking Pack, safety and assurance is further enhanced through the use of additional cameras in the front grille and the housing of the two exterior mirrors, which support entry and exit from tight spaces. The driver can also choose between different image representations in the MMI display, including a live "bird's eye view" image for parking. Only in combination with memory mirrors (6XF or 6XL), electrically adjustable front seats (PV3 or PS8) and Technology Pack (WB4 or WB7)	●	●	£1,310.00

Options are subject to availability and may extend delivery.

- = Not available
- = Available
- S = Standard

RRP – Recommended Retail Price.

VAT is calculated at 20% but this may alter to reflect any change in the applicable VAT rate.



Audi Parking system with top view featured in Parking Pack Advanced



Park Assist featured in Parking Pack and Parking Pack Advanced

# Packages

Order Code		A6 allroad	A6 allroad Sport	Total RRP inc VAT
<b>WTG</b>	<p><b>Entertainment Pack:</b> Offers the perfect systems to keep all your passengers happy, however long your journey</p> <ul style="list-style-type: none"> <li>- TV tuner for reception to free-to-air TV channels. Reception dependent on local network availability. Picture display only possible on MMI screen when your A6 allroad is stationary, audio available at all times</li> <li>- Rear seat entertainment system includes two separate portable entertainment units, each with a 9" screen* mounted to the back of the front seats. Playback available from a variety of sources including Bluetooth, CD/DVD, SD Card, USB and AV. Carry case, remote control, table-top stand, 2.5 hour battery for external playtime, charging lead and headphones also included. Only available in combination with Technology Packs (WB4 or WB7)</li> </ul>	●	●	£2,020.00
<b>WFL</b>	<p><b>Convenience Pack:</b> An option pack featuring numerous useful items to make your A6 allroad as practical and functional as possible</p> <ul style="list-style-type: none"> <li>- The luggage compartment comes with a reversible mat and load area fixing kit which includes a fixing set for the rail system with a telescopic pole and fastening strap for dividing up the luggage area. A through-load facility for long items is also provided which comes complete with a removable ski/snowboard bag</li> <li>- Passengers in the rear seat will be able to manually adjust blinds on the rear window and rear side windows to their preference. Front and rear high quality jacquard fabric Vimentum Floor mats complete this pack</li> </ul>	●	●	£730.00

Options are subject to availability and may extend delivery.

- = Not available
- = Available
- S = Standard

\*Screens must be ordered by your local Audi Centre via Audi Genuine Accessories.

RRP – Recommended Retail Price.

VAT is calculated at 20% but this may alter to reflect any change in the applicable VAT rate.



Audi entertainment mobile featured in Entertainment Pack



Load area fixing kit

# Headlights

Intelligent technology designed to give you better all-round awareness and safety on the road.

Options are subject to availability and may extend delivery.

- = Not available
- = Available
- S = Standard

RRP - Recommended Retail Price.

VAT is calculated at 20% but this may alter to reflect any change in the applicable VAT rate.

Order Code		A6 allroad	A6 allroad Sport	Total RRP inc VAT
8G1	<b>High-beam assist</b> - variable headlight range control featuring a camera on the interior mirror which registers sources of light from other road users. The range and width of the headlight beam are continuously varied between dipped and main beam to suit ambient conditions, ensuring that the headlights provide good visibility without dazzling other road users. Only available in combination with standard Xenon Headlights	•	S	£140.00
PX2	<b>All-LED headlights including high-beam assist.</b> LED technology provides lower energy consumption and enhanced contrast with a colour similar to daylight, for increased safety and good recognition by other road users. Includes all-weather light function to reduce the risk of the driver being dazzled when visibility is poor (in fog, rain or snow). Also includes high-beam assist which automatically adjusts headlights from high-beam to dipped-beam when another vehicle is approaching or when other ambient lighting is detected (i.e. street lights) by a camera on the interior mirror. Includes Dynamic rear indicators which dynamically sweep from inside to out within 0.15 seconds. This helps to clearly identify not only that the vehicle is turning but in which direction - increasing road safety as it is easier for other road users to determine which way cars are moving in a shorter amount of time. Not available in combination with Audi Matrix LED headlights (PXC)	•	S	£1,350.00
PXC	<b>Audi Matrix LED headlights</b> - A direct evolution of Audi's LED headlights, Audi Matrix technology provides maximum and precise illumination at all times without dazzling other road users. The vehicle uses information obtained from multiple sources including the interior mirror camera and navigation system to identify the appropriate lighting required; using GPS data the vehicle will use high beam, but will automatically switch to dipped lighting when entering built up areas; whilst high beam is in use, and oncoming traffic is detected, the Matrix beam dips or fully extinguishes individual lighting diodes. Matrix beam is capable of establishing and tracking multiple road users and illuminating the appropriate corridors of lights either side of them to maintain maximum visibility of the road and surrounding environment without causing disruption to other drivers. Matrix beam technology includes Dynamic front and rear indicators which dynamically sweep from inside to out within 0.15 seconds. This helps to clearly identify not only that the vehicle is turning but in which direction - increasing road safety as it is easier for other road users to determine which way cars are moving in a shorter amount of time	•	-	£2,500.00
		-	•	£1,150.00



All-LED headlights including high-beam assist



Audi Matrix LED headlights



# Audio and communication

Stay in touch using our range of communication functions, and give each journey its own soundtrack with our advanced audio equipment.

Options are subject to availability and may extend delivery.

- = Not available  
 • = Available  
 S = Standard

RRP – Recommended Retail Price.

VAT is calculated at 20% but this may alter to reflect any change in the applicable VAT rate.

Order Code		A6 allroad	A6 allroad Sport	Total RRP inc VAT
<b>6G2</b>	<b>DVD/CD changer in glove compartment.</b> DVD/CD changer, for 6 DVDs or CDs, supports audio CDs, video DVDs, shock-resistant and easily accessible in the glove compartment. Only in combination with Technology packs (WB4 or WB7)	•	•	£640.00
<b>8RY</b>	<b>BOSE® surround sound</b> - 14 speakers including centre speaker in the dashboard and subwoofer in the spare wheel well - 12-channel amplifier with a total output of over 600 Watts - Acoustics specially tuned to the interior - Surround sound reproduction 5.1 (in combination with MMI Navigation Plus) and stereo recordings (CD, radio, MP3) - AudioPilot for noise-compensating volume adjustment - Powerful, precise bass reproduction	•	•	£1,000.00
<b>8RF</b>	<b>Bang &amp; Olufsen Advanced sound system</b> - 15 speakers including subwoofer and centre speaker, each with its own amplifier channel for genuine 5.1 surround sound - 15-channel DSP full-digital amplifier with a total output of over 1,200 Watts, fully digitised and highly efficient 5-channel ICEPower amplifier for woofers and subwoofer - When switched on, two acoustic lenses extend from the dashboard for excellent sound rendition and perspective from all seats - Polished aluminium speaker covers - Acoustics specially tuned to the interior through the targeted use of tweeters, mid-range speakers and woofers - Speakers in encapsulated housings isolate music and telephone conversations within the vehicle for privacy, e.g. when making phone calls in hands-free mode - Automatic adjustment of volume to the driving situation Only available in combination with MMI Navigation Plus (WB4 or WB7). Please note that this option will reduce the boot space	•	•	£6,300.00



Bang & Olufsen Advanced sound system



BOSE surround sound

# Audio and communication

Order Code	A6 allroad	A6 allroad Sport	Total RRP inc VAT
<p><b>Head-up display.</b> An optical system of mirrors projects driving-related information directly into the driver's field of vision. To prevent ghost images, a special windscreen with a wedge-shaped film is fitted. This film measures approximately 26 x 9cm in size, and the driver perceives the display to be 2 to 2.5m beyond the windscreen. The display has many benefits:</p> <ul style="list-style-type: none"> <li>- Helps to increase safety, convenience and driving pleasure</li> <li>- Straightforward operation via MMI</li> <li>- Display is height-adjustable, adjusts to ambient brightness</li> <li>- High resolution of up to 480 x 240 pixels</li> </ul> <p><b>KS1</b></p> <ul style="list-style-type: none"> <li>- The following are displayed, however some are dependent on additional options being chosen:               <ul style="list-style-type: none"> <li>- Road speed</li> <li>- Navigation instructions</li> <li>- Adaptive cruise control status, distance from vehicle ahead and set speed (optional)</li> <li>- Warning messages from optional night vision assistant (optional)</li> <li>- Infotainment lists</li> <li>- Audi active lane assist (optional)</li> <li>- Speed limit display (optional)</li> </ul> </li> </ul>	●	●	£1,240.00

Options are subject to availability and may extend delivery.

- = Not available
- = Available
- S = Standard

RRP – Recommended Retail Price.

VAT is calculated at 20% but this may alter to reflect any change in the applicable VAT rate.



Head-up display

# Interior equipment

Specify every detail of your car's interior with this range of exclusive options.

Order Code		A6 allroad	A6 allroad Sport	Total RRP inc VAT
QQ1	<p><b>Lighting package. Includes lighting for exterior:</b></p> <ul style="list-style-type: none"> <li>- Courtesy lighting on the underside of the door handles and LED door handle lighting for easy entry and exit in the dark</li> <li>- Automatic activation when the doors are unlocked</li> <li>- Active internal door reflectors</li> </ul> <p><b>Interior:</b></p> <ul style="list-style-type: none"> <li>- Entrance lighting</li> <li>- 2 reading lights at front and rear</li> <li>- Front footwell</li> <li>- Inside door handles</li> <li>- Make-up lights</li> <li>- Storage compartment in the centre console</li> <li>- Ambient lighting of the centre console</li> <li>- Ambient reflected light for inside door trims</li> </ul>	●	●	£250.00
QQ2	<p><b>Ambient lighting.</b> In addition to interior and exterior lighting package (QQ1), anti-glare LED illumination for the passenger compartment. Lighting for door pockets, footwells and inside door handles, reflected lighting for centre console and door inner panels to help occupants find their way around. Surround lighting for centre console (floating effect), make-up lights at front and active door reflectors, with illuminated door sill trims. Configured via MMI</p>	●	●	£550.00
7HB	<p><b>Extended leather package.</b> Lower part of the centre console, armrests in the doors and door pull handles in leather. Only available in combination with Milano leather (NSW) or leather/Alcantara (N7U)</p>	●	●	£515.00
7HE	<p><b>Leather covered door armrests.</b> Only available in combination with Valcona leather (NSD)</p>	●	●	£335.00
	<p>In combination with Audi design selection, Flint grey (PEX)</p>	●	—	No charge
1XT	<p><b>3-spoke leather-trimmed multi-function Sports steering wheel – heated.</b> With gear-shift paddles</p>	●	●	£200.00
6NQ	<p><b>Cloth Headlining – Black.</b> Not available in combination with interior code WI</p>	●	●	£250.00
6NA	<p><b>Audi exclusive headlining in Alcantara.</b> Headlining, upper pillar trim and sun visors in black Alcantara. Only in combination with interior codes VV/FZ/VT/VY/WI</p>	●	●	£2,280.00
2C7	<p><b>Electrically adjustable steering column.</b> Adjustable for height and reach with auto easy entry and exit function. Only available in combination with electric front seats (PV3/P58)</p>	●	●	£400.00

Options are subject to availability and may extend delivery.

– = Not available  
● = Available  
S = Standard

RRP – Recommended Retail Price.

VAT is calculated at 20% but this may alter to reflect any change in the applicable VAT rate.

# Exterior equipment

Make sure your car looks exactly as you want it to by selecting some of our striking options.

Options are subject to availability and may extend delivery.

- = Not available  
 ● = Available  
 S = Standard

\*Additional wiring is required for auxiliary equipment.

RRP – Recommended Retail Price.

VAT is calculated at 20% but this may alter to reflect any change in the applicable VAT rate.

Order Code		A6 allroad	A6 allroad Sport	Total RRP inc VAT
6XE	<b>Exterior mirrors</b> – heated, electrically adjustable, automatic kerb view function which tilts the passenger mirror downwards towards the kerb when reverse gear is engaged and electrically folding	●	–	£235.00
6XF	<b>Exterior mirrors</b> – heated, electrically adjustable, electrically folding, automatic kerb view function which tilts the passenger mirror downwards towards the kerb when reverse gear is engaged and with memory function. Only available in combination with electric front seats (PV3/PS8) In combination with Technology Pack Advanced (WB7)	●	S	£235.00
		●	S	No charge
6XL	<b>Exterior mirrors</b> – heated, electrically adjustable, electrically folding and auto-dimming, with automatic kerb view function which tilts the passenger mirror downwards towards the kerb when reverse gear is engaged. Includes memory function. Only available in combination with electrically adjustable front seats (PV3/PS8) In combination with Technology Pack Advanced (WB7)	●	–	£515.00
		–	●	£280.00
		●	●	£280.00
VW4	<b>Privacy glass.</b> Dark tinted rear and rear-side windows (from B-pillar backwards)	●	S	£390.00
1D4	<b>Tow bar.</b> Ball head and ball joint coupling made from forged steel. Mechanically swivelling ball head, operated via Bowden cable, with indicator light on Bowden cable and display in instrument cluster to monitor secure attachment of trailer towing hitch, includes trailer stabilisation system via the Electronic Stability Control (ESC). Includes single European 13-pin electric socket and may require a 13- to 7-pin adaptor. Please consult your Audi Centre for details*	●	●	£825.00
3FU	<b>Panoramic glass sunroof.</b> Comprises two sections, whereby the front glass section can be tilted or slid open and closed again electrically. Includes electrically operated sun blind for the front and rear passengers. Can also be closed from the outside via the central locking	●	●	£1,250.00
GZ2	<b>Power door closure.</b> Automatically pulls closed doors that are not completely engaged into the lock	●	●	£620.00
Z20	<b>Removal of model and technology designation</b>	●	●	No charge
VJ1	<b>Full paint finish.</b> Includes front and rear bumpers, wheel arches and side sills painted in body colour with a matt finish. Not in combination with Brilliant black A2, Ibis white T9, Garnet red 9C and Diamond beige N3	●	●	£535.00



Panoramic glass sunroof



Privacy glass



# Safety and security

Order Code		A6 allroad	A6 allroad Sport	Total RRP inc VAT
7W1	<p><b>Pre-sense basic.</b> Audi Pre-sense is a comprehensive technical package for identifying dangers well in advance and intervening appropriately. Pre-sense basic networks the different vehicle systems, enabling driving situations to be categorised and, where necessary, actions to be taken to protect the driver and passengers. These include: belt tightening, activating the hazard warning system, closing the windows and the sunroof (if fitted)</p>	•	•	£260.00
QR9	<p><b>Speed limit display.</b> The prevailing speed limit can be simply read on the Driver's Information System (DIS). Should the camera fail to see a sign properly, the speed limit from the data for the navigation system will be shown instead.</p> <p>The advantages:</p> <ul style="list-style-type: none"> <li>- Display of the speed limits currently registered, which can be called up in the Driver's Information System at any time</li> <li>- Display can be called up in every instrument cluster view and in the head-up display (optional equipment)</li> <li>- Camera-based system is also capable of detecting temporary speed restrictions in roadworks and on digital displays (e.g. over motorways) within the system limits</li> <li>- Display of national speed limits for Western European countries</li> </ul> <p>Only in combination with Technology Pack Advanced (WB7)</p>	•	•	£250.00

Options are subject to availability and may extend delivery.

- = Not available  
 • = Available  
 S = Standard

RRP – Recommended Retail Price.

VAT is calculated at 20% but this may alter to reflect any change in the applicable VAT rate.



Speed limit display

# Safety and security

Order Code		A6 allroad	A6 allroad Sport	Total RRP inc VAT
9R1	<b>Night vision assistant.</b> Assists the driver when driving at night by displaying a thermal image of the surroundings. People and large wild animals are highlighted in yellow in the colour display of the Driver's Information System. If the system determines from their position that there is a potential risk, the marking changes to red, a warning triangle appears and a warning tone is emitted. Warning can also be shown in the Head-up display (KS1) if ordered. In combination with Audi Matrix LED headlights (PXC), LED headlights (PX2) or High-beam assist (8G1) the highlighted person is also illuminated with 3 successive brief flashes of the headlight. System operation maybe restricted in too much ambient light, high humidity and high night temperatures (over 28°C). Only in combination with Technology packs (WB4 or WB7)	•	•	£1,750.00
PG3	<b>Advanced key.</b> Access and authorisation system that works through automatic data exchange between key and vehicle, allowing the driver to keep their car key in their pocket or bag at all times. To unlock and open, simply lift the exterior door handle. The door is locked by pressing the button on the handle. Pressing the start/stop button integrated in the centre console starts and stops the engine	•	•	£750.00
4X4	<b>Rear side airbags.</b> For the outer rear seats, incorporated into the seat backrests; supplements the side impact protection in the doors and the standard airbag systems	•	•	£375.00
7G9	<b>Tracking preparation.</b> Fitting for the connection of a tracking assistant, which enables the vehicle to be located if stolen. Please contact your local Audi Centre for full details	•	•	£110.00

Options are subject to availability and may extend delivery.

- = Not available
- = Available
- S = Standard

RRP – Recommended Retail Price.

VAT is calculated at 20% but this may alter to reflect any change in the applicable VAT rate.



Night vision assistant

## Looking after your Audi

When you've chosen your ideal model, it's reassuring to know that it will remain in safe hands. That's why we've created products to protect your Audi, from extended warranties to Audi Complete – our comprehensive service and maintenance package. And there's also a range of Audi accessories and merchandise to choose from, enabling you to further enhance and safeguard your car.







# Audi Complete

If you drive under 10,000 miles per annum your vehicle will be placed on a Fixed Inspection Service schedule. If your mileage tends to exceed 10,000 miles per annum it will be placed on the Flexible Service schedule.

## Warranty

All new Audi models now come with a choice of three, four or five-year warranty.\* What's more, if you decide to sell your Audi before the warranty expires, it will be fully transferred to the new owner. So, whichever length of warranty you choose, you can forget about unexpected repair bills and enjoy several years of carefree driving.

Options are subject to availability and may extend delivery.

- = Not available  
 ● = Available  
 S = Standard

\*Three-year warranty consists of a two-year unlimited-mileage warranty and a third year warranty with a 60,000-mile limitation. Four-year warranty consists of a two-year unlimited-mileage warranty and two further years' coverage with a 75,000-mile limitation. Five-year warranty consists of a two-year unlimited-mileage warranty and three further years' coverage with a 90,000-mile limitation.

\*\*Only available before registration of your A6 allroad. Please speak to your Audi Centre for full details.

RRP - Recommended Retail Price.

VAT is calculated at 20% but this may alter to reflect any change in the applicable VAT rate.

Audi Complete is our fixed-cost maintenance plan, which helps you keep your Audi in top condition and stay in control of your finances. For a simple monthly payment, you could cover your car's servicing, maintenance and, if you want, its tyres too.

So not only will you ensure your car runs smoothly, you'll also protect its future resale value. And because everything's covered by one competitive price, there's no need to go anywhere else.

Pricing is completely tailored to your vehicle and takes into consideration the options you have on your vehicle and your likely annual mileage and resultant service schedule. Please speak to your Audi Centre for a personalised quote for Audi Complete.

Order Code		A6 allroad	Total RRP inc VAT
-	<b>Audi Warranty.</b> Covering you for unlimited mileage in the first 2 years of ownership, and up to 60,000 miles in the third year. Transferable between owners**	●	No charge
EA6	<b>Audi Warranty.</b> Covering you for up to 4 years or 75,000 miles, whichever comes sooner. Cover includes a 2 year unlimited mileage warranty, and up to 75,000 miles in the third and fourth years. Transferable between owners**	●	£560.00
EA9	<b>Audi Warranty.</b> Covering you for up to 5 years or 90,000 miles, whichever comes sooner. Cover includes a 2 year unlimited mileage warranty, and up to 90,000 miles in the third, fourth and fifth years. Transferable between owners**	●	£1,335.00



## Accessories

Choosing an Audi isn't just a matter of deciding on the model you want; it's about creating a car that suits your needs perfectly. And that's why we've developed a whole range of accessories to enhance your A6 allroad, enabling you to customise it down to the last detail. Like your Audi, all these accessories are developed to the highest possible standards. They're all available exclusively from Audi. To find out more, just visit your local Audi Centre.

### Warranty

All of the accessories available on the A6 allroad are covered by a three-year warranty\* if they are ordered and included in the purchase price of the car at date of delivery. Any accessories ordered and installed after delivery include a two-year warranty.\*

\*Excluding Road Angel products.

Audi Accessories warranty terms and conditions can be found at [audi.co.uk](http://audi.co.uk)



## Merchandise

From the enthusiasts' motorsport collection to the sophisticated Audi collection, there's a wide variety of adults' and children's clothing, lifestyle accessories and collectables, all of which bear the Audi name.

Please speak to a member of our team at your local Audi Centre to see the full Audi collection and to place an order. A selection of Audi merchandise is also available to buy from [audi.co.uk/merchandise](http://audi.co.uk/merchandise)



Image shown is the Audi kids' car legends, item number 320.13.004.00

# The Audi Difference

## The experts in Vorsprung durch Technik

Our Audi Approved Master Technicians have undergone an impressive 100,000 hours of training over a 10-year programme to ensure they have the latest technical expertise for maintaining and servicing your Audi. All our Service Advisors undergo a specialist induction and training to ensure they are Audi professionals and able to talk to you about any issues you may have with your Audi vehicle.

## Servicing tailored to your needs

Regular servicing is key to safeguarding your Audi's performance and a full Audi service history could help you enhance the future re-sale value. To make servicing easy, the Audi Service Schedules have been designed to work with your individual driving style and vehicle.

We offer two different schedules: the Fixed Inspection Service and the Flexible Service schedule. The conventional Fixed Inspection Service schedule has fixed intervals for the Oil-change Service and Inspection Service, which are determined by time and distance.

With the Flexible Service schedule, the Inspection Service intervals are also fixed but the Oil-change Service intervals are variable. Sensors take account of driving style and conditions to determine when the Oil-change Service is required and the driver is informed via the on-board service interval display.

The choice of Service Schedule will depend on journey type and mileage as well as individual driving style and conditions. The table to the right can be used for guidance but your Audi Centre will help you to determine the most suitable Service schedule for you based on your individual circumstances and preferences.

## Fixed Inspection Service Schedule

	<b>Vehicle usage:</b>
<b>Mileage</b>	Less than 10,000 miles per annum Mainly city/town centre driving. Short journeys.
	<b>Service Intervals:</b>
<b>Oil-change Service</b>	Fixed to every 9,000+ miles/1 year
<b>Inspection Service</b>	Fixed to every 19,000+ miles/2 years

## Flexible Service Schedule

	<b>Vehicle usage:</b>
<b>Mileage</b>	More than 10,000 miles per annum Motorway and main road driving. Mainly longer distance journeys. Constant speeds.
	<b>Service Intervals:</b>
<b>Oil-change Service</b>	Variable to a maximum of every 19,000+ miles/2 years
<b>Inspection Service</b>	Fixed to every 19,000+ miles/2 years

When a vehicle is frequently used in the following conditions, we recommend a Fixed Inspection Service Schedule, regardless of mileage:

Uneconomical driving styles, e.g. heavy acceleration and braking, constant use of high revs

High engine-loading conditions, e.g. frequent towing and hill climbs

\*As indicated by the service interval display. Mileages are approximate as the Service Indicator system uses kilometres as its distance measurement.

## Your convenience comes first

At Audi you can choose from a range of convenient services that suit your needs. Why not book a 'service while you wait' appointment\* and enjoy our complimentary refreshments while your car is with us? Or, if you need to be mobile, take advantage of one of our courtesy cars which we can even deliver to you.\* We guarantee we can service your Audi within 5 days without a courtesy car or within 10 days if you need transport. We will also ensure your car is returned to you with a full valet.

## Audi Genuine Parts

You can rest assured that only Audi Genuine Parts will be used on your vehicle. What's more, Audi parts and labour come with a 2-year guarantee.\*\*

## No hidden costs

We believe strongly in transparency when it comes to our prices. For added peace of mind, we will give you a quotation over the phone for the work you have requested and email you the price confirmation. We'll consult you if any additional work on your car is needed when it is with us. We won't carry out any extra work without asking your permission first.

## All part of the service

Whenever we see an Audi for a service, we connect it directly to our headquarters in Ingolstadt which enables us to check your car's software and make sure it's as up-to-date as possible. If the factory has released a software upgrade for your model, it can be applied immediately - improving anything from your car's efficiency to the precision of its parking system.

## Audi Roadside Assistance

Your new car comes complete with 3 years' complimentary roadside assistance and recovery across the UK, provided by Automobile Association Insurance Services Limited. Also included is roadside assistance throughout Europe, managed by Automobile Association Insurance Services Limited.

For further information and terms and conditions please visit [audi.co.uk](http://audi.co.uk)

\*Subject to availability.

\*\*Excludes wear and tear.





# A6 allroad technical data

	Diesel		
Engine	3.0 TDI quattro	3.0 TDI quattro	3.0 BiTDI quattro
Transmission	7-speed S tronic	7-speed S tronic	8-speed tiptronic
Cylinder	6-cylinder	6-cylinder	6-cylinder
Displacement, cubic cm (valves per cylinder)	2967 (4)	2967 (4)	2967 (4)
Max. power, <sup>2</sup> PS at rpm	218/3250-4500	272/3500-4250	320/3900-4600
Max. torque, Nm at rpm	500/1250-3000	580/1500-3250	650/1400-2800
Top speed, mph	141	155*	155*
0-62mph acceleration, seconds	7.3	6.2	5.5
CO <sub>2</sub> emissions, <sup>2</sup> g/km	149	149	172
Benefit in kind (BIK)%	27%	27%	32%
Fuel consumption, <sup>2</sup> mpg (l/100km) Urban	44.1 (6.4)	44.1 (6.4)	36.7 (7.7)
Fuel consumption, <sup>2</sup> mpg (l/100km) Extra Urban	54.3 (5.2)	54.3 (5.2)	48.7 (5.8)
Fuel consumption, <sup>2</sup> mpg (l/100km) Combined	50.4 (5.6)	50.4 (5.6)	43.5 (6.5)
ABI insurance group 1-50 <sup>+</sup>	39E	42E	43E
Unladen weight, <sup>3</sup> kg	1890	1895	1955
Gross weight limit, kg	2520	2525	2585
Roof load limit/nose weight, kg	100/100	100/100	100/100
Max trailer load unbraked, <sup>4</sup> kg	750	750	750
Max trailer load with 12% gradient, <sup>4</sup> kg	2500	2500	2500
Max trailer load with 8% gradient, <sup>4</sup> kg	2500	2500	2500
Luggage compartment capacity, rear seats upright, litres	565	565	565
Fuel tank capacity approx, litres	73	73	73
Emission standard	EU6 <sup>^</sup>	EU6 <sup>^</sup>	EU6 <sup>^</sup>

\*Electronically limited

<sup>^</sup>The addition of AdBlue technology ensures compliance with EU6 emission standards. The AdBlue tank may require refilling between services.

<sup>+</sup>Highest insurance group rating shown. Group may be lower dependent on trim level. Please visit [www.thatcham.org/abigrouprating](http://www.thatcham.org/abigrouprating) for details.

<sup>2</sup>The given value was obtained in accordance with the specified measurement procedure (the respective current version of the Directive 80/1269/EEC).

<sup>3</sup>Fuel consumption and CO<sub>2</sub> emissions figures are obtained under standardised test conditions (Directive 93/116/EEC) using a representative model. This allows direct comparison between different models from different manufacturers, but may not represent the actual fuel consumption achieved in 'real world' driving conditions. More information is available at [www.dft.gov.uk/vca](http://www.dft.gov.uk/vca)

<sup>4</sup>Vehicle's unladen weight without driver (calculated in accordance with the current version of Directive 80/1268/EEC). The fitting of additional equipment may increase the vehicle's unladen weight and drag coefficient, whereupon the potential carrying capacity and top speed will be correspondingly reduced.

<sup>5</sup>The engine's power output always goes down with increasing altitude. At 1,000m above sea level, and for every additional 1,000m, deduct 10% from the weight of the outfit (trailer load limit + gross weight of the towing vehicle).

**Please note:** The maximum power output figures are quoted in PS (or Pferdestärke, which is the metric equivalent of brake horsepower). To convert to brake horsepower, divide the PS figure by 1.0139.

# A6 allroad dimensions

The technical drawings opposite show the exact dimensions of the A6 allroad, so you can check everything - from whether the car will fit in your garage to whether your luggage will fit in the boot.

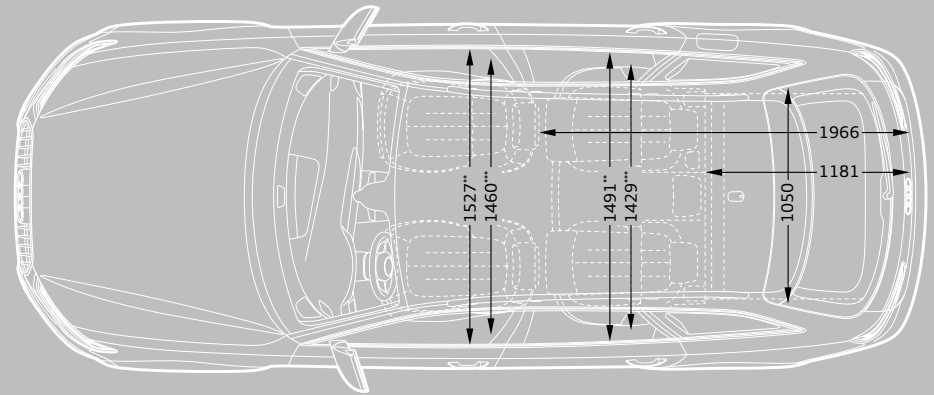
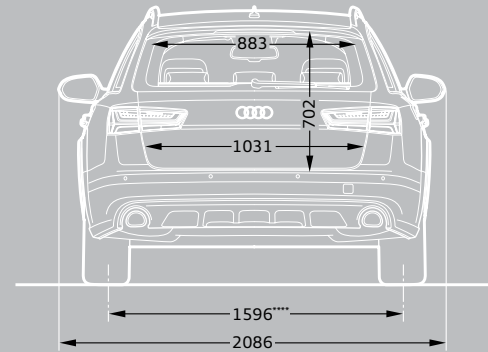
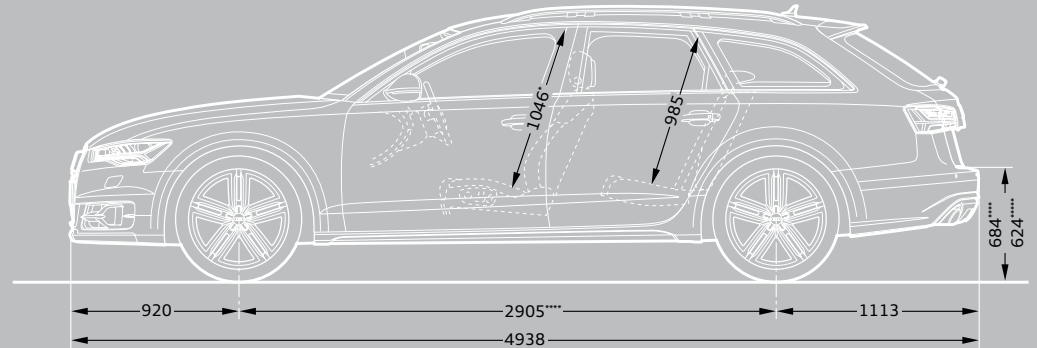
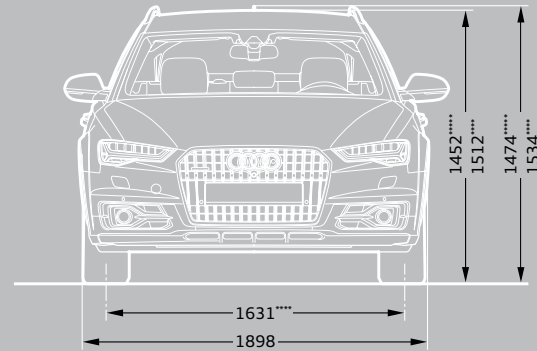

Dimensions measured with vehicle at unladen weight.

Turning circle approx 11.9m.

Dimensions in millimetres.

- \*Maximum headroom.
- \*\*Elbow room width.
- \*\*\*Shoulder room width.
- \*\*\*\*Lift mode.
- \*\*\*\*\*Dynamic mode.

# Pricing and Additional information

## Welcome to Audi

By placing an order for your Audi, you're choosing to get behind the wheel of one of the most sophisticated cars on the road. And because we believe the service we offer should be just as advanced, we want to let you know exactly what you can expect from us, now and in the future.

We've agreed a set of standards with all our Centres which governs the way we do business with you. It outlines the kind of service we promise to deliver for every customer, right down to filling each new Audi we sell with half a tank of fuel.

So whether you're interested in the date your car will arrive in the UK or the way we'll dispose of non-biodegradable materials after we service your Audi, you can have total confidence in us.

## Audi Promise

### Audi Centres

We guarantee that all our Centres will be open as follows:

Sales: Monday to Friday 9am–6pm  
Saturday 9am–5pm

Service: Monday to Friday 8am–6pm  
Saturday 8.30am–1pm

Sunday opening is at local discretion.

### New car delivery

Once we've confirmed a delivery date for your car, we'll keep you informed of progress. Subject to reasonable notice, we'll then deliver it to a place of your choice, whether that's your home or work. In the unlikely event of a delay, we'll provide a courtesy car to minimise inconvenience and keep you mobile.

### Environmental commitment

We promise to dispose of all non-biodegradable materials from your vehicle in a responsible manner.

### Pricing

Prices and specifications given are correct at the time of printing. Always check details with your Audi Centre as Audi policies are continually developing. We reserve the right to change prices or specifications at any time.

All prices are subject to VAT, currently charged at 20%, but this may alter to reflect any change in the applicable VAT rate.

Delivery charges and number plates are not included in the vehicle price.

Delivery charge	£504.99
Number plate	£20.00
VAT	£105.01
Total	£630.00

## Audi Customer Care

Every new Audi benefits from the comprehensive Audi Customer Care Package, which comprises:

- ▶ A 3-year Audi warranty, which covers you for unlimited mileage in the first 2 years of ownership, with a full mechanical and electrical warranty which covers you for up to 60,000 miles in the 3rd year
- ▶ A 3-year paint warranty
- ▶ A 12-year anti-corrosion warranty
- ▶ 3 years' UK roadside assistance and recovery

You also have the option when ordering your new car of choosing a 4-year or 5-year Audi warranty. Speak to a member of the sales team for more information.

### Audi tax-free sales

If you are entitled to purchase a vehicle free of VAT, normally through military or diplomatic privilege, please contact your local Audi Centre for full details.

Should you have any difficulty obtaining the information you require, please call 01908 548 356.

### Audi Financial Services

Audi Financial Services specialises in providing funding solutions for Audi drivers. Whether your Audi is for private or business use, there is a range of funding options to choose from.

Below is the full range of finance products, which comprises:

- ▶ Solutions – a Personal Contract Plan
- ▶ Hire purchase
- ▶ Lease purchase
- ▶ Finance lease
- ▶ Contract hire

With all products, you can choose a fixed-cost maintenance plan designed to help you budget accurately.

No matter which Audi model you choose, your local Audi Centre can provide you with a personalised quote designed to fit your budget and motoring needs.

Audi Financial Services is a trading name of Volkswagen Financial Services (UK) Limited. An offer of finance depends on certain conditions. Available to people over 18 in the UK only.

### Audi Insurance

We want you to start enjoying your new car from day one and thanks to Audi complimentary five day insurance you can. To activate simply call 0330 303 6900, provide us with a few details, and we'll send a cover note to your Audi Centre. They will then tax your car and you can drive it away. Telephone lines are open Monday to Friday 8am – 8pm and Saturday 9am – 4pm. For details of our full range of Insurance products visit [insurewithaudi.co.uk](http://insurewithaudi.co.uk)

## CO2 data and information

### CO2 emissions-based Vehicle Excise Duty

Vehicle Excise Duty (Road Fund Licence) is based upon the amount of Carbon Dioxide (CO<sub>2</sub>) a vehicle emits, measured in grams per kilometre (g/km).

First year VED rates apply to the first year of ownership. Annual VED rates apply thereafter. The DVLA has created thirteen categories:

Petrol and Diesel engines	First year	Annual rate (second year onwards)
A – up to 100g/km	£0.00	£0.00
B – 101 to 110g/km	£0.00	£20.00
C – 111 to 120g/km	£0.00	£30.00
D – 121 to 130g/km	£0.00	£110.00
E – 131 to 140g/km	£130.00	£130.00
F – 141 to 150g/km	£145.00	£145.00
G – 151 to 165g/km	£180.00	£180.00
H – 166 to 175g/km	£295.00	£205.00
I – 176 to 185g/km	£350.00	£225.00
J – 186 to 200g/km	£490.00	£265.00
K – 201 to 225g/km	£640.00	£290.00
L – 226 to 255g/km	£870.00	£490.00
M – over 255g/km	£1,100.00	£505.00

Vehicle Excise Duty (VED) rates correct at time of going to print, but these may alter to reflect any change in the applicable VED rate.

## Audi Connect

An external data source is required to enable Audi Connect online services. One of the two can be used:

1. A mobile telephone with Bluetooth SIM Access Profile – to check the compatibility of your mobile phone and whether it has SIM Access Profile compatibility, please visit [www.audi.co.uk/phonecompatibility](http://www.audi.co.uk/phonecompatibility)
2. A separate SIM card which can be inserted in the included SIM card reader. When a separate SIM card is used, hands-free phone calls are possible using the SIM card or by connecting a different mobile telephone via Bluetooth Hands Free Profile

Online services are only available for mobile phone contracts or SIM cards which include a data option with the use of LTE, if LTE usage is required. Online services will only be available within the coverage of the mobile phone network; there may be additional costs for the use of these services (charges and billing correspond to the personal mobile phone contract or SIM card contract). Due to high data volumes, a mobile phone contract including an unlimited or high usage data plan is strongly recommended. The content and scope of the online based services offered may vary.

The Audi Connect services are provided for at least one year from vehicle delivery. After 24 months from delivery of the vehicle, the term of the Audi Connect services will be extended free of charge once for 12 months.

Audi Connect enables access to the services of Google and Twitter. Permanent availability cannot be guaranteed as this is the responsibility of Google and Twitter.

Please note that the services received are also dependent on the capability of your mobile phone.

Google and the Google logo are registered trademarks of Google Inc.

The availability of services supported by Audi Connect varies from country to country.

### Online Map updates

The map version delivered can be updated with the first 5 updates which are issued at intervals of 6 months. The Current navigation data can be downloaded from the myAudi Platform at [www.audi.com/myaudi](http://www.audi.com/myaudi) and installed in the vehicle via SD card. In conjunction with Audi Connect, the update can be carried out online in the vehicle. In addition it is possible to have the new navigation data installed by an Audi partner at extra cost.









**Audi UK**

Customer Services  
Selectapost 29  
Sheffield  
S97 3FG  
0800 699888  
audi.co.uk

Specifications and prices subject  
to change without notice.

© Audi (UK)

Printed in the UK  
Edition 2.2 06/15  
2016 model year

Images are for illustrative purposes only.

