

MINI COUNTRYMAN. MINI PACEMAN.







MINI COUNTRYMAN.	08
MINI PACEMAN.	14
YOUR MINI COUNTRYMAN AND MINI PACEMAN IN DETAIL.	20
Models.	22
Colours and wheels.	28
Exterior and interior.	36
Technology and equipment. Entertainment and communications.	58
MINI equipment packages.	70
John Cooper Works.	74
John Cooper Works Tuning. Genuine MINI Accessories.	80
Concept and safety. MINI Data.	84
MINI Service.	96
MINI Financial Services. Warranty. Recycling.	97
MINI standard and optional equipment.	98

[MINI.CO.UK/CONFIGURATOR](https://www.mini.co.uk/configurator)

This link will take you straight to
the online MINI Configurator.

Details of fuel consumption and CO₂ emissions for all models, as required under EU law, can be found in the Technical Data section on pages 92–94.

More information on standard and optional equipment is available on pages 98–101 of this brochure.





THE SAME ALARM CLOCK. THE SAME CUP
OF COFFEE. THE SAME ROUTE TO WORK.
THE SAME DULL ROUTINE – DAY IN,
DAY OUT. WHY SETTLE FOR TEDIUM?
DO SOMETHING OUT OF THE ORDINARY.
STEP INTO A MINI AND ESCAPE THE
MUNDANE. HEAD FOR A WORLD THAT HAS
CAPTIVATED GENERATIONS. A WORLD
OF LIMITLESS INDIVIDUALITY. THE WORLD
OF MINI. A WORLD WHERE ANYTHING
CAN HAPPEN. EXCEPT BOREDOM.

**NOT
NOR
MAL**

www.MINI.com/notnormal

**MINI COUNTRYMAN.
MINI PACEMAN.**

MINI COUNTRYMAN.

Anyone can go with the flow – but true individuals will go their own way. Rocky road? No problem. After all, as the saying goes: there's no such thing as the wrong way – just the wrong car. The MINI Countryman, of course, is exactly the right car. With powerful petrol or diesel engines and optional ALL4 all-wheel drive, it'll take you anywhere. Even off the beaten track.



**A CAR THAT GOES
ITS OWN WAY.**







ALL-WHEEL DRIVE FOR ALL SITUATIONS.

Whatever the terrain, the largest, most powerful model in the MINI family is guaranteed to keep you moving. The MINI John Cooper Works Countryman delivers outstanding performance on every surface, offering responsive control, incredible torque and ALL4 all-wheel drive as standard. The vehicle also features the overboost function, temporarily providing up to 300 newton-metres of torque, in the unlikely event that you need a little extra kick. But despite its power, the 160-kilowatt/218-horsepower¹ engine is particularly economical when it comes to fuel consumption.

¹ Details of fuel consumption and CO₂ emissions for all models, as required under EU law, can be found in the Technical Data section on pages 92–94.

**FOUR TIMES THE TALENT.
THE MINI COUNTRYMAN AT A GLANCE.**





1 CONCEPT: REVOLUTIONARY.

A MINI with four doors, an external length of over four metres and optional ALL4 all-wheel drive. There's never been anything like it – until now. The Countryman is unmistakably MINI, with its high shoulder line, unique proportions and distinctive front end. Not to mention its virtually limitless scope for personalisation.

2 ENJOYMENT: INDESCRIBABLE.

A unique level of agility and the trademark MINI go-kart feeling mean that the MINI Countryman delivers outstanding traction on any surface. The result is unparalleled driving enjoyment, in any situation. It's hard to believe – until you try it for yourself.

3 PRACTICALITY: EXCEPTIONAL.

The vehicle is functional on the outside, with four wide-opening doors, and a tailgate with a large loading aperture, and flexible on the inside, with a sophisticated MINI Centre Rail and a 60:40 split adjustable rear seat bench for three people that slides backwards and forwards up to 13 centimetres and 40:20:40 folding rear seat backrests – making it exceptionally versatile, outside and in.

4 SPACE: GENEROUS.

Over four metres long, there's more room here for passengers and luggage than in any other MINI. Thanks to 350 to 1,170 litres of luggage capacity – depending on the position of the rear seat – no matter how much you pack, setting off for a holiday is just as much fun as the holiday itself.

MINI PACEMAN.





DESIGN WITH BITE.

The MINI Paceman is eye-catching without being intrusive. Its all-new design turns heads all around town. One look under the bonnet of the latest addition to the MINI family and it's clear that it has everything you need for an enjoyable drive. Four engine types are available, packing up to 184 horsepower (135 kilowatts) and ready to take you down the city's liveliest streets. ALL4 all-wheel drive is optional. As for style – that comes as standard.

For more information on the MINI Paceman, see www.MINI.com/Paceman





A PERFORMANCE ARTIST.

THE MINI JOHN COOPER WORKS PACEMAN.

The MINI John Cooper Works Paceman skilfully blends the elegance of a Sports Activity Coupé with the performance of a sports car. On the inside, Anthracite dials, John Cooper Works door sill finishers and Chili Red stitching on the sport seats, leather steering wheel, gear lever knob and gaiter capture the essence of the racetrack.

On the outside, stylish light-alloy wheels combine with optional sport stripes, contrast roof and exterior mirror caps in exclusive Chili Red to make the MINI John Cooper Works Paceman a real work of art. And the technology is just as impressive – so as well as looking like an out-and-out sports car, you can be sure that it drives like one too.

Interested? Then head to your MINI dealer for more information on the MINI John Cooper Works Paceman and to book a test drive today.



**CHARACTER STUDY.
THE MINI PACEMAN AT A GLANCE.**



1 DESIGN: CLASSY.

Lengthened doors, a tapering shoulder line, muscular rear wheel arches and a dynamic sloping roof – no MINI has ever been this sporty and elegant. The horizontal design of the new rear lights complements its coupé profile, and there are also plenty of familiar, iconic MINI design elements, such as the radiator grille, side scuttles, elliptical mirrors and the contrast roof. In short, the design is unmatched and unmistakable.

2 PERFORMANCE: OUTSTANDING.

Lowered sporty suspension and a positive direct steering feel. State-of-the-art engines that combine immediate acceleration and excellent responses with optimum fuel-efficiency. Top-class traction with Dynamic Traction Control (DTC) and ALL4 all-wheel drive available as options. Put it all together and you get an enjoyable drive that surpasses any other.

3 VERSATILITY: INCREDIBLE.

The MINI Paceman is equally impressive when it comes to everyday practicality. Wide-opening doors, tilting and sliding front seats that ease access for rear passengers, 330 to 1,080 litres of luggage capacity and two individual folding seats in the rear. Countless storage compartments and sophisticated features like the MINI Centre Rail make it even more versatile, and ready to handle the fresh challenges that each new day brings.

4 INTERIOR: LOGICAL.

Sometimes less is more – and more is always a good thing. That's why you'll find a surprising amount of room for four beneath the elongated roof of the MINI Paceman. Two comfortable individual seats in the rear turn this unique Sports Activity Coupé into a mobile lounge.

**YOUR
MINI COUNTRYMAN
AND MINI PACEMAN
IN DETAIL.**

MODELS.



TWO MODELS, COUNTLESS POSSIBILITIES AND ONE PIECE OF GOOD NEWS: YOU CAN'T GO WRONG.

To start with, all you have to do is work out which model suits you best: the MINI Countryman or the MINI Paceman. Once you've established your favourite, the personalisation process really gets into gear. Choose an engine type, colours, seats and upholstery, interior and equipment. But don't worry – good looks are guaranteed, whichever model you go for. And with the new model name lettering on the tailgate, you can be sure that both vehicles will make an impression.

MINI.CO.UK/CONFIGURATOR

The complete collection: use the MINI Configurator to put together your dream MINI, down to the smallest detail.

MINI ONE COUNTRYMAN. MINI ONE D COUNTRYMAN.

Whether you choose the petrol driven 98 horsepower MINI One or the high-torque 90 horsepower MINI One D, the roof always come in body colour and blends harmoniously into a rear spoiler in the same colour. Other details that make the MINI One/D Countryman immediately recognisable include exterior mirror caps in Matt Black, roof rails in Matt Silver and side scuttles in the same colour with orange indicator lights.



With a Chrome-edged radiator grille and lower air intake in Brilliant Black, the distinctive front end is a real head turner.



At the rear the features include the distinctive MINI boot opener located within the MINI wings, chrome exhaust tailpipe finisher and ONE badge.

MODELS.



MINI COOPER COUNTRYMAN. MINI COOPER D COUNTRYMAN. MINI COOPER D ALL4 COUNTRYMAN.

The MINI Cooper Countryman is available with either a 122-horsepower petrol engine or a 112-horsepower diesel engine. The MINI Cooper D Countryman can also be fitted with ALL4 all-wheel drive. For either model, the roof and exterior mirror caps are available either in body colour and, on request, at no cost in contrast colours (Black or White). Other visual highlights include the Matt Silver roof rails and side scuttles with orange indicator lights.



Utterly unique: striking Silver radiator grille slats on all MINI Cooper and Cooper D Countryman models.



Finished in the same colour as the roof, the rear spoiler blends perfectly into the roofline. The distinctive tailpipe is Chrome-plated.

**MINI COOPER S COUNTRYMAN.
MINI COOPER S ALL4 COUNTRYMAN.
MINI COOPER SD COUNTRYMAN.
MINI COOPER SD ALL4 COUNTRYMAN.**

The MINI Cooper S Countryman features an impressive 1.6-litre twin-scroll turbo engine that delivers 184 horsepower, while the MINI Cooper SD Countryman comes with a 2-litre common-rail diesel engine offering 143 horsepower and 305 newton-metres of torque. ALL4 all-wheel drive is available as an option for both engine types. The roof and exterior mirror caps are available either in body colour or in contrast colours (Black or White), and the roof rails, side scuttles and exclusive light-alloy wheels come in a stylish Matt Anthracite. Other highlights include the red Cooper S emblems and the White indicator lights in the side scuttles.¹



There's an unmistakably sporty feel to the front of all MINI Cooper S and SD models: it features a hexagon-mesh radiator grille, central air intake between the bonnet and front bumper and air ducts for the brakes in the lower air intake.



At the rear, the two Chrome-plated tailpipes of the exhaust system and the exclusive design of the rear spoiler on the S/SD models underline their sporting prowess.

¹ Visual shows optional equipment incl. bi-xenon headlights.

MODELS.



MINI COOPER PACEMAN. MINI COOPER D PACEMAN. MINI COOPER D ALL4 PACEMAN.

The Cooper version of the MINI Paceman gets the range off to a strong start, delivering 122 horsepower. The MINI Cooper D Paceman provides plenty of torque along with 112 horsepower, plus ALL4 all-wheel drive is available as an optional extra. The roof and exterior mirror caps come in a choice of body colour or contrast colours – White or Black – for both engine types, and the Matt Silver side scuttles feature orange indicator lights.¹



Make an entrance: the radiator grille on all MINI Cooper and Cooper D Paceman models includes attractive Silver slats and wide Chrome edging. The lower radiator grille features a three-dimensional design that adds extra depth.



Exit in style: with a rear spoiler finished in the same colour as the roof and Chrome plating on the tailpipe, the MINI Cooper/D Paceman and MINI Cooper D ALL4 Paceman are unmistakable from the rear. All Paceman models also proudly display their model name on the bootlid.

¹ Visual shows optional equipment incl. White direction indicator lights.

**MINI COOPER S PACEMAN.
MINI COOPER S ALL4 PACEMAN.
MINI COOPER SD PACEMAN.
MINI COOPER SD ALL4 PACEMAN.**

The MINI Cooper S features a 1.6-litre twin-scroll turbo engine with an output of 184 horsepower, while the MINI Cooper SD model comes with a powerful 2.0-litre common-rail diesel engine that delivers 143 horsepower. Optional ALL4 all-wheel drive is available for both engine types. Each variant bears the mark of a star performer: Matt Anthracite side scuttles with red S emblems and White indicator lights. The roof and exterior mirror caps are available in a choice of body colour or contrasting Black or White.



Viewed from the front, the hexagon mesh radiator grille, large air intake between the radiator grille and the bumper and brake-cooling air ducts all emphasise the sporty nature of the MINI Cooper S/SD Paceman models.



At the rear the Cooper S and SD models feature a rear roof spoiler in the respective roof colour and two chrome-plated exhaust tailpipes.

**COLOURS AND
WHEELS.**

COLOURS.

EXTERIOR COLOURS.

Life is full of colours. Which is why the MINI Countryman and the MINI Paceman offer a wide range of exclusive metallic and non-metallic paint finishes that can be combined in a host of different ways. The roof, exterior mirror caps and bonnet stripes all offer rich opportunities for contrasts, allowing you to put a stylish personal stamp on your car.

MINI One/D Countryman:

- Roof in body colour, exterior mirror caps in Matt Black

MINI Cooper/D Countryman, MINI Cooper D ALL4 Countryman, MINI Cooper S/SD Countryman, MINI Cooper S/SD ALL4 Countryman, MINI Cooper/D Paceman, MINI Cooper D ALL4 Paceman, MINI Cooper S/SD Paceman, MINI Cooper S/SD ALL4 Paceman:

- Roof and exterior mirror caps in body colour as standard
- Roof and exterior mirror caps in Black as a no cost option
- Roof and exterior mirror caps in White as a no cost option

Depending on the model and the alloy wheel design chosen, light-alloy wheels are also available in four different colours (see "Wheels", pages 34/35).

NON-METALLIC COLOURS.

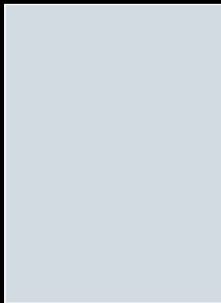

B15
Light White







B19
Light Coffee¹

MINI.CO.UK/CONFIGURATOR

The ideal way of testing the various colour combinations for your MINI.

ROOF COLOURS.

-  Contrast roof in White
-  Contrast roof in Black
-  Roof in body colour (seen here: Oxford Green metallic)
-  Roof in Chili Red (exclusive to John Cooper Works)

EXCLUSIVE TO JOHN COOPER WORKS.



851
Chili Red

EXCLUSIVE TO MINI PACEMAN.



B62
Starlight Blue metallic

¹ Not available for MINI Paceman.

METALLIC COLOURS.



B63
Blazing Red metallic



B26
Oxford Green metallic



B12
Crystal Silver metallic



B60
Brilliant Copper metallic



B14
True Blue metallic¹

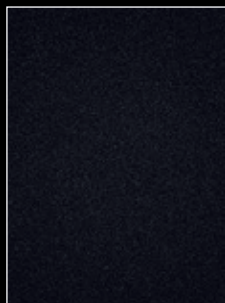

B11
Absolute Black metallic



A48
Royal Grey metallic

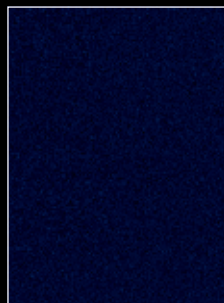

B13
Cosmic Blue metallic¹

COLOURS.

IN LINE WITH YOUR
PERSONAL STYLE.
MINI BONNET STRIPES.



Bonnet stripes in White



Bonnet stripes in Black

Bonnet stripes in **White** are available in conjunction with a White roof.
Bonnet stripes in **Black** are available in conjunction with a Black roof.

[MINI.CO.UK/CONFIGURATOR](https://www.mini.co.uk/configurator)

The ideal way of testing the various
colour combinations for your MINI.



Roof in body colour



Roof in White



Roof in Black

BLACK. WHITE. BRIGHT. MINI COLOUR THEORY.

The roof of the MINI One/D Countryman always comes in body colour, with exterior mirror caps in Matt Black as standard.

If the roof of all MINI Cooper/D, Cooper S/SD models are painted in body colour, then the exterior mirror caps also come in body colour as standard.

However for MINI Cooper/D, Cooper S/SD models, the roof is also available in contrast Black or White at no extra cost. If this choice is specified then the exterior mirror caps will be painted in Black or White to match the roof colour.

Exterior mirror caps in Chrome are available as an option in conjunction with any model or roof colour.



Exterior mirror caps in Chrome

WHEELS.

STREET SMART.

A classy set of wheels adds the finishing touch to any MINI. Take a look at the extensive selection of light-alloy wheels and choose the one that best suits you and your chosen MINI.

MINI.CO.UK/CONFIGURATOR



Use the Configurator to see the wheel of your choice on your MINI.



18" 5-Star Double Spoke Composite, Matt Anthracite



16" steel wheels, incl. centre hubcaps



16" 5-Star Single Spoke, Silver



17" 5-Star Double Spoke, Silver



17" 5-Star Double Spoke, Black



17" 5-Star Double Spoke,
Matt Anthracite



18" Turbo Fan, Silver



18" Turbo Fan, Matt White



18" Turbo Fan, Matt Anthracite



18" 5-Star Double Spoke Composite,
Black



17" 5-Hole Black Star, Black



19" Y-Spoke, Light Anthracite

EXCLUSIVE TO
MINI PACEMAN.



18" Twin Spoke, Black Burnished



19" Cross Spoke Crusher, Black

EXCLUSIVE TO
JOHN COOPER WORKS.

For more information about standard and optional equipment and tyres, please see pages 98–101.

In addition to the factory-fitted wheel sets, certain wheel designs are also available as winter complete wheels.

Please contact your MINI Dealer for more information on winter wheels and tyres.

**EXTERIOR AND
INTERIOR.**

EXTERIOR.

ALL THAT GLITTERS ... IS CHROME.

We all know you only get one chance to make a first impression. The Chrome Line Exterior package available for the MINI Countryman and the MINI Paceman enhances selected areas of the bodywork with generous amounts of Chrome. So wherever you go, you're sure to shine.



MINI Cooper/D Countryman and MINI Cooper D ALL4 Countryman:
Chrome Line Exterior



MINI Cooper S/SD Countryman and MINI Cooper S/SD ALL4 Countryman:
Chrome Line Exterior



MINI Cooper/D Countryman and MINI Cooper D ALL4 Countryman:
Chrome Line Exterior



MINI Cooper S/SD Countryman and MINI Cooper S/SD ALL4 Countryman:
Chrome Line Exterior

At the front end, the **Chrome Line Exterior** consists of Chrome plating for the radiator grille slats and the surround for the lower grille. At the rear, the registration plate surround in the bumper is Chrome-plated, as are the side scuttles with built-in orange direction indicator lights.

The **Chrome Line Exterior** includes Chrome plating for the brake-cooling air ducts in the front air intake, a Chrome bar in the rear bumper and Chrome-plated side scuttles with White indicator lights. Where the Chrome Line Exterior option is specified, the roof rails are finished in Matt Silver.



MINI Cooper/D Paceman and MINI Cooper D ALL4 Paceman:
Chrome Line Exterior



MINI Cooper S/SD Paceman and MINI Cooper S/SD ALL4 Paceman:
Chrome Line Exterior



MINI Cooper/D Paceman and MINI Cooper D ALL4 Paceman:
Chrome Line Exterior



MINI Cooper S/SD Paceman and MINI Cooper S/SD ALL4 Paceman:
Chrome Line Exterior



MINI Cooper/D and MINI Cooper D ALL4 Countryman/Paceman:
Chrome Line Exterior



MINI Cooper S/SD and MINI Cooper S/SD ALL4 Countryman/Paceman:
Chrome Line Exterior

The **Chrome Line Exterior** package comprises Chrome plating for the radiator grille slats, a Chrome surround for the lower air intake, Chrome-plated side scuttles and a Chrome surround for the registration plate in the bumper.

The **Chrome Line Exterior** package features Chrome on the air inlets, side scuttles and the registration plate surround in the bumper.

EXTERIOR.



1. Bi-xenon headlights



2. Adaptive headlights



3. Black headlight reflectors



4. Rear fog light, MINI Countryman



5. Fog lights



6. White direction indicator lights

1. The optional **Bi-xenon headlights** for low-beam and main-beam, with headlight beam-throw control and headlight washer system, offer particularly powerful illumination.

2. The **adaptive headlights**, featuring automatic headlight beam-throw control, ensure optimum illumination whether driving in city or country, and allow drivers to see further ahead on the motorway. Sensors measure the steering angle and vehicle speed, and electric motors then adjust the position of the light beam accordingly to suit the speed and direction of the car (only available in conjunction with Bi-xenon headlights).

3. The **Black headlight reflectors** are available in conjunction with Bi-xenon headlights, Adaptive Headlights and White direction indicator lights.

4. **4+7.** The MINI Countryman and the MINI Paceman both feature a single **rear fog light** built into the rear light on the driver's side. The corresponding section of the passenger-side rear light houses the reversing light.

5. The **fog lights** are built into the front bumper, and offer improved safety when visibility is poor.



7. Rear fog light, MINI Paceman



8. Rear-mounted rack preparation



9. Tow bar with removable ball head

6. The **White direction indicator lights** option comprises clear glass for the indicators in the front headlights and side scuttles.

8. The **rear-mounted rack preparation** for multifunctional carrier systems from the MINI Genuine Accessories range, such as bicycle carriers, is located in the rear bumper. When not in use it is concealed by two covers.

9. **Tow bar with removable ball head.** Please consult your MINI Dealer for maximum towing weights (model dependent).



10. Comfort access system



11. Comfort access system

10.–11. The **comfort access system** allows you to lock and unlock the car without even having to touch the key. Simply having one of the two keys in your pocket or handbag is enough. You can also switch the ignition on and off keylessly, simply by pressing the Start/Stop button.

EXTERIOR.



1. Panoramic glass sunroof – open MINI Countryman



2. Panoramic glass sunroof – MINI Countryman, adjusted from the front and the rear



3. Panoramic glass sunroof – MINI Paceman, adjusted from the front

1.–3. The large opening of the **panoramic glass sunroof** creates an extremely spacious feel and provides plenty of fresh air. It can be electrically adjusted – from the front and the rear in the MINI Countryman, from the front only in the MINI Paceman – and via remote control for maximum convenience. Tinted glass and two detachable roller sunblinds built into the central section of the roof protect the occupants from bright sunlight.

4. **Darkened rear glass** reduces heat build up and glare in the interior of the car, making things more comfortable for the occupants. The glass is visibly darker from the B-pillars backwards (including the rear windscreen).



4. Darkened rear glass



5. MINI Paceman roof rails

5. Practical and stylish, the **roof rails** are fitted as standard on the MINI Countryman and are available as an option for the MINI Paceman. They enable roof boxes, cycle carriers, ski carriers and other attachments to be easily fixed to the vehicle, and since aesthetic appeal is such an important part of every MINI, they also blend effortlessly into the design of the car. Available in Silver for the MINI One/D Countryman and Cooper/D models. Also available in combination with the Chrome Line Exterior for Cooper S/SD and John Cooper Works models. Comes in Anthracite for Cooper S/SD and John Cooper Works models without the Chrome Line Exterior. Maximum load: 75 kilograms.

FUN ALL THE WAY.



1. Sports suspension



2. ALL4

1. The **sports suspension set-up** delivers even sportier and more precise handling responses, thanks to its stiffer damper settings. 10 millimetres lower than the standard suspension, it looks good too.

2. The MINI Cooper D, Cooper S and Cooper SD Countryman and Paceman models are available with **ALL4** all-wheel drive, providing you with that extra level of security and enabling you to head off the beaten track. The unmistakable ALL4 emblem appears on both front doors.



3. Rear spoiler



4. Rear spoiler

3. The **rear spoiler** is always painted in the same colour as the roof, and fits seamlessly into its lines.

4. The distinctive **MINI Cooper S/SD Countryman** and **MINI Cooper S/SD Paceman** rear spoiler comes in the same colour as the roof and fits in perfectly with the sporty personality of these models.

INTERIOR.

TRUE BEAUTY IS ON THE INSIDE.

INTERIOR DESIGN ELEMENTS.

As well as the interior colour, there are a variety of Colour Line options to choose from for the door mirrors and the decorative insert in the MINI Centre Rail – to create the perfect interior. Various options are also available for the cockpit surface and interior surface.

- 1 **Dashboard**
- 2 **Dashboard Trim** (decorative trims in the dashboard)
- 3 **Door Ellipse and Down Tubes** (side surrounds on the centre console and door ellipses)
- 4 **Colour Line** (door panels and decorative insert in the Centre Rail)
- 5 **Decorative inner rings** (in Brilliant Black or Chrome as part of Chrome Line Interior option)
- 6 **Interior colour**





5

3

3

4

6

INTERIOR.

DOOR ELLIPSE, DOWN TUBES AND DASHBOARD TRIM.

An interior with atmosphere: the MINI One/D Countryman, MINI Cooper/D Countryman and MINI Cooper D ALL4 Countryman all offer the option of door ellipse and down tubes in Dark Silver. On the MINI Cooper/D Paceman and MINI Cooper D ALL4 Paceman, this comes as standard. On the MINI Cooper S/SD Countryman, MINI Cooper S/SD ALL4 Countryman, MINI Cooper S/SD Paceman and MINI Cooper S/SD ALL4 Paceman, the standard door ellipse and down tubes are a sporty, elegant Dark Anthracite. Piano Black is also available as a stylish option on all models. All these finishes – Dark Silver, Dark Anthracite and Piano Black – can also be specified for the dashboard trim. The rings around the speedo, centre air vents and gear lever knob always come in Carbon Black, while the decorative inner rings on the speedo and air vents come in Brilliant Black as standard. If the Chrome Line Interior is specified, the decorative inner rings on the air vents, rev counter and speedo are Chrome-plated.



MINI One Countryman with standard interior. Rings around speedo and all air vents in Carbon Black, decorative inner rings in Piano Black.



MINI Cooper Countryman with interior and cockpit surface in Dark Silver and Chrome Line Interior package: rings around speedo in Carbon Black, all air vents in Carbon Black, decorative inner rings Chrome-plated.

INTERIOR SURFACES.

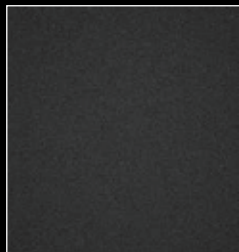

Dark
Anthracite

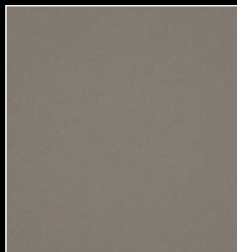

4DB
Dark Silver



4BD
Piano Black

EXCLUSIVE TO JOHN COOPER WORKS.

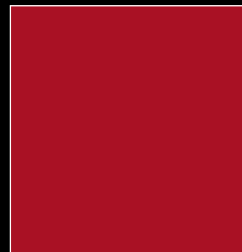

4CY
Chili Red

COLOUR LINE.

The door mirror and the decorative insert in the MINI Centre Rail are available in the Colour Line colours Carbon Black, Polar Beige, Dark Tobacco or Pure Red. The Colour Line colours Red Copper and Satellite Grey are also available exclusively on the MINI Paceman. To ensure a harmonious overall effect, the choice of Colour Line colours depends on the colours specified for the interior and upholstery.

MINI.CO.UK/CONFIGURATOR

Use the Configurator to learn more about the interior of your MINI.

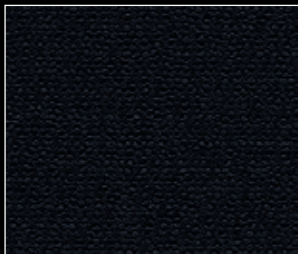

4C1
Carbon Black

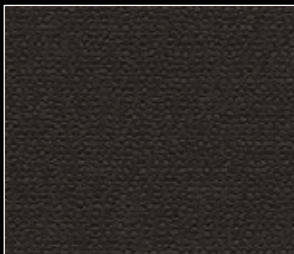

4C4
Dark Tobacco

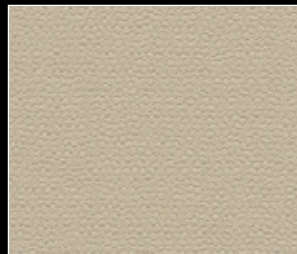

4C2
Polar Beige

EXCLUSIVE TO MINI PACEMAN.



4C5
Pure Red

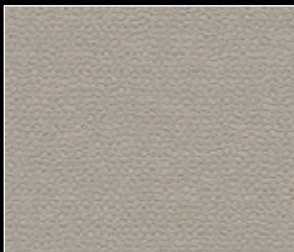

4C3
Satellite Grey

EXCLUSIVE TO MINI PACEMAN.

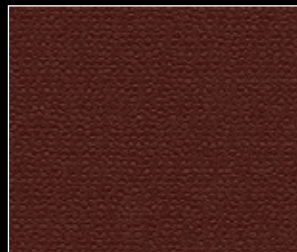

4EM
Red Copper

INTERIOR.

GOOD TASTE IS ALWAYS IN STYLE.



- 1 Interior colour
- 2 Colour Line
- 3 Armrest

CLOTH/LEATHER HOT CROSS SPORT SEAT
EXCLUSIVE TO MINI PACEMAN

[MINI.CO.UK/CONFIGURATOR](https://www.mini.co.uk/configurator)

Use the Configurator to learn more about the seats in your MINI.

Illustrations show seats for the MINI Countryman and MINI Paceman. May vary depending on the model.

SEATS.

Whether you prefer standard or sport seats, in cloth, cloth/leather or leather, there's one thing all seats in the MINI Countryman and the MINI Paceman have in common: they combine total comfort with the MINI go-kart feeling – on and off the beaten track. Fasten your seat belt!

LOUNGE LEATHER
SPORT SEAT



CLOTH
STANDARD SEAT



GRAVITY LEATHER
SPORT SEAT



INTERIOR.



Cosmos cloth²
APE1 Carbon Black/Light Tobacco



Diagonal Track cloth³
BBE1 Carbon Black/Carbon Black

EXCLUSIVE TO MINI JOHN COOPER WORKS.



Diagonal Track cloth³
BBP9 John Cooper Works/Carbon Black



Parallel Lines cloth/leather³
FSGZ Carbon Black/Light Tobacco



Parallel Lines cloth/leather³
FSGY Carbon Black/Pure Red

EXCLUSIVE TO MINI PACEMAN.



Cloth/leather
BFE1 Hot Cross

UPHOLSTERY AND SEATS.¹

Your seat, your rules: choose from a variety of cloth, leather and cloth/leather combination upholsteries for your MINI Countryman or MINI Paceman, all with colour-coordinated interiors.

[MINI.CO.UK/CONFIGURATOR](https://www.mini.co.uk/configurator)



Use the MINI Configurator to try out various combinations of upholstery and interior colours.

**EXCLUSIVE TO
MINI PACEMAN.**

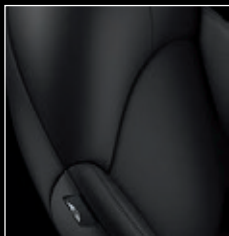

Gravity leather^{4,5}
T6E1 Carbon Black



Gravity leather^{4,5}
T6GK Satellite Grey



Gravity leather^{4,5}
T6GW Polar Beige

**EXCLUSIVE TO MINI
JOHN COOPER WORKS.**



Lounge leather^{4,5}
T9E1 Carbon Black



Lounge leather^{4,5}
T9GX Light Coffee



Lounge leather^{4,5}
T9IN Carbon Black Championship Red

**EXCLUSIVE TO
MINI PACEMAN.**



Lounge leather^{4,5}
T9RX Red Copper

Illustrations show seats and upholstery for the MINI Countryman and MINI Paceman. May vary depending on the model.

¹ With matching interior colour combinations.

² Only for standard seat.

³ Only for sport seat.

⁴ Only for sport seat with piping.

⁵ Leather upholstery includes seats (base and backrest), and front and rear headrests.

INTERIOR.



1. Chrome Line Interior



2. Chrome Line Interior (rev counter)



3. Chrome Line Interior (speedo)

1.–3. The ring on the steering wheel, the decorative ring in the air-conditioning control area and the glove compartment and door handles are always finished in Chrome. If the optional **Chrome Line Interior** is specified,

a Chrome finish is applied to the rings around the central round instrument and the rev counter, as well as all the air vents in the instrument panel.



1. Two-spoke leather steering wheel



2. Three-spoke sports leather steering wheel with multi-function option



3. Interior Lights Pack



4. Storage Compartment Pack

1. The **two-spoke leather steering wheel** has a driver airbag built in. The wide Chrome ring is an eye-catching design detail.

2. The **three-spoke leather steering wheel** is also available with a **multi-function option**, allowing drivers to operate cruise control, radio and telephone functions without taking their hands off the wheel.

3. In addition to the standard interior light in the headliner, the **Interior Lights Pack** includes front reading lights, an illuminated vanity mirror, lights in the front footwells and an instrument panel backlight. And for that extra-special finishing touch, the Ambient Lighting for the door mirrors, armrest and MINI Centre Rail can cycle steplessly through all the colours of the spectrum.

4. Optimised for the short, full-length and two-section variants of the Centre Rail, the **Storage Compartment Pack** is the perfect way to keep the interior of your MINI Paceman or MINI Countryman in order. For models fitted with a full-length MINI Centre Rail, it includes two additional cup holders, a stylish glasses compartment, a horizontal iPhone/iPod holder¹ for the front and a vertical iPhone/iPod holder² for the rear. The package also includes two bag hooks³, fixing elements for the front cupholders, a storage net in the front passenger footwell, a 12-volt socket in both the back row of seats and the luggage compartment, and a third sun visor fitted at the side of the headliner. For MINI Countryman and MINI Paceman models fitted with a short or two-section MINI Centre Rail, the number of features included in the package is reduced.

¹ The holders are also compatible with many other smartphones.

² Only available in conjunction with the full-length MINI Centre Rail.

INTERIOR.

ADJUSTS TO SUIT YOUR MOOD.



One of the most striking features of the interior is the aluminium **MINI Centre Rail**, which runs down the middle of the car between the driver and passenger seats. In conjunction with the Storage Compartment Pack, different elements can be mounted on this, sliding along and locking into place where you want them. A fixed decorative insert in the Colour Line colour ensures the MINI Centre Rail is coordinated with the interior colour scheme. Where the optional MINI navigation system and MINI Radio Visual BOOST are fitted, the MINI Centre Rail is also equipped with a joystick for controlling them. Furthermore, various designs of the MINI Centre Rail are available for the MINI Countryman and the MINI Paceman.



1. MINI Countryman with short MINI Centre Rail and five seats



2. MINI Paceman with optional full-length MINI Centre Rail



3. MINI Paceman with standard two-section MINI Centre Rail

1. The MINI Countryman is configured as standard with five seats and a **short MINI Centre Rail** with two dividing elements.
2. As an option, the MINI Paceman can be fitted with the **full-length MINI Centre Rail** with three dividing elements. This provides all occupants with easy access to the system.
3. The MINI Paceman comes as standard with a **two-section MINI Centre Rail** with three dividing elements. It features separate compartments for the front and the rear.



4. Three-seat bench in the MINI Countryman with individually sliding sections (60:40 split)



6. Lounge rear seats in MINI Paceman, four-seat models



5. MINI Countryman backrest with a 40:20:40 split. Sections can be tilted and folded down separately



7. Lounge rear seats in MINI Paceman, four-seat models

4.+5. Where the **three-seat bench** is specified for the MINI Countryman, the sections of the rear bench are split 60:40 and can be moved 13 cm forwards and backwards independently of each other. The backrest has a 40:20:40 split, and the sections can be tilted and folded down separately.

6.+7. In the interests of keeping the rear as comfortable and luxurious as possible, the MINI Paceman is only available as a **four-seater**. Its relaxed lounge rear seats fold down separately with a 50:50 split.

INTERIOR.



ROOM TO SPARE.

Highly inviting: with an external length of over four metres, the MINI Countryman and the MINI Paceman are the largest members of the MINI family. Their wide-opening tailgates can accommodate virtually everything you might need for everyday driving, weekend excursions or going on holiday.

The luggage compartment of the MINI Countryman holds between 350 and 1,170 litres, depending on the position of the rear seat bench. The MINI Paceman is equally generous, offering between 330 and 1,080 litres. Both vehicles come with a wide range of cleverly designed compartments offering extra storage space, while Genuine MINI Accessories provide the ideal solutions for larger logistical challenges.



The MINI Countryman comes as standard with a **luggage compartment cover**. In the vertical position, this separates the luggage area from the passenger space, and when folded down into the horizontal position, it provides a flat loading surface. It can also be taken out entirely. A **removable flat load-compartment floor** is available as an option. This covers the depression in the bottom of the luggage compartment, while creating an additional hidden storage area. On the MINI Paceman, the removable flat load floor comes as part of the luggage compartment package. In conjunction with the optional Storage Compartment Pack, the MINI Countryman and MINI Paceman also come with a 12-volt socket in the luggage compartment. This is suitable for items like cool boxes.

[MINI.CO.UK/CONFIGURATOR](https://www.mini.co.uk/configurator)

Use the Configurator to learn more about the interior of your MINI.

**TECHNOLOGY AND
EQUIPMENT.
ENTERTAINMENT AND
COMMUNICATIONS.**

TECHNOLOGY AND EQUIPMENT.



The large **speedo** is positioned in the middle of the instrument panel and incorporates various warning lights and the fuel gauge.



If the MINI navigation system or MINI Radio Visual BOOST is fitted, then the **speedo** runs around the outside of the central round instrument.

INFORMATION IS EVERYTHING.



1. Rev counter



2. On-board computer



3. Rain sensor



Once the key is in the ignition, the **Start/Stop button**, fitted as standard, can be used to switch the engine on or off.

1. Fitted as standard, the **rev counter** is mounted on the middle of the steering column. The upper display shows the current speed, while the lower display shows information such as the trip distance or seat belt warning for the rear seats. It also includes the Shift Point Display¹, telling you which gear is the most economical at any given moment.

2. The **on-board computer**² tells you your range, current and average fuel consumption, and average speed at the touch of a button.

3. When the **rain sensor**² is activated, it automatically switches on the windscreen wipers when necessary, and adjusts their speed to how hard it is raining. The built-in light sensor automatically switches on the driving lights when needed in dark or twilight conditions.

¹ Shift point display for manual transmission vehicles only.

² On-board computer and rain sensor optional.

TECHNOLOGY AND EQUIPMENT.



1. Exterior mirror package



2. Six-speed Automatic Transmission Steptronic

1. If the **exterior mirror package** is specified, the two aspherical exterior mirrors are heated and can be folded away electrically. Windscreen washer jet heating is also included.

The **rear-view and exterior mirrors with automatic anti-dazzle function** dim the light from the headlights of following vehicles if this reaches a certain level of intensity.

CHANGE GEAR.



3. Shift paddles on three-spoke sports leather steering wheel

2.+3. The **six-speed Automatic Transmission Steptronic** makes gear changes easier and – in Steptronic mode – decidedly sporty. To allow drivers to make manually initiated automatic gear changes quickly and safely, the Cooper S/SD models featuring Steptronic, as standard also come with two **shift paddles on the three-spoke sports leather steering wheel**. These shift paddles are also available as an option on the MINI One Countryman, MINI Cooper/D Countryman and MINI Cooper/D Paceman.



4. Air conditioning



6. Heated front windscreen



5. Automatic air conditioning



7. Seat heating

4. The **air conditioning system** with microfilter means passengers can enjoy their ideal interior temperature, whatever the conditions outside. The amount and distribution of conditioned air can be adjusted to suit individual requirements.

5. **Automatic air conditioning** rapidly adjusts the interior temperature to the level you have selected, and then keeps it there. The built-in active carbon filter protects passengers against unpleasant odours from outside.

The manual air circulation function is automatically switched off after a set interval – turn-off time is between one and 15 minutes, depending on the outside temperature – to maintain just the right level of fresh air inside the car.

6. The **heated front windscreen** ensures drivers can always see clearly, allowing them to heat the front windscreen at the touch of a button, and also includes the rain sensor and automatic headlight activation.

7. The **seat heating** option allows both the driver and front-seat passenger to choose between three seat temperature settings.

ENTERTAINMENT AND COMMUNICATIONS.



LET MINI ENTERTAIN YOU.

It'll take you just five steps to personalise the information, communications and entertainment functions. The first is to choose your radio head unit. With its large display, the MINI Radio Visual BOOST is a particularly powerful portal to exciting new dimensions of interactivity. You can then pick and choose from the available service, music and Bluetooth/USB categories to suit your personal requirements, from MINI Connected to the MINI navigation system (only a selection of the full range is shown here). Whatever your tastes, you're sure to find the ideal solution.

The **MINI Radio BOOST CD** comes as standard and includes a twin line display, an RDS tuner with aerial diversity for optimum reception of DAB digital radio, FM, MW and LW stations. The built-in CD player with MP3 decoder has a title search function and fast forward and rewind and music can be played back from compatible devices connected to the USB port in the centre rail. Also you can display and control functions from compatible Bluetooth phones.¹

1 RADIO HEAD UNITS.

2 MUSIC.

3 BLUETOOTH/USB.

4 NAVIGATION SYSTEM.

5 MINI CONNECTED.

¹ In order to use the full functionalities of Apple iPod/iPhone apps, a special audio/video adapter for Apple iPod/iPhone (Y-cable) is required. This must be purchased separately, and is not part of the equipment option.

² For information on the compatibility of devices for audio, video and telephone functions, visit: MINI.com/connectivity

1 RADIO HEAD UNITS.



1. MINI Radio BOOST CD



2. MINI Radio Visual BOOST

1. The MINI Radio BOOST CD provides a great range of features and outputs your music choice via 6 speakers including 2 bass speakers located under the front seats. Overall you have an impressive 96 Watts of music output available to satisfy your needs.

2. The MINI Radio Visual BOOST has all the features of the MINI Radio BOOST CD, and then some: a high-resolution 6.5-inch display with comfortable intuitive control system and a distinctive MINI look and feel, a Bluetooth hands-free kit with USB audio interface, an on-board computer and an audio/video adapter for the Apple iPod/iPhone. The built-in video function (in conjunction with compatible video-capable Apple devices) allows videos to be watched on the display when the car is stationary. The MINI Radio Visual BOOST is "MINI Connected ready", meaning that for a small cost you can specify the MINI Connected option which opens a whole new world of in-car connectivity options.²

ENTERTAINMENT AND COMMUNICATIONS.

2 MUSIC.



1. harman/kardon hi-fi loudspeaker system



2. harman/kardon hi-fi loudspeaker system



3. harman/kardon hi-fi loudspeaker system in the rear side panel of the MINI Paceman

1.–2. **harman/kardon hi-fi loudspeaker system:** a digital multichannel amplifier and a total of ten high-performance speakers seamlessly integrated into the vehicle interior deliver a unique sound experience, thanks to a total output of up to 640 watts, with powerful bass and brilliant treble.

3. Music lounge: the **harman/kardon hi-fi loudspeaker system** in the MINI Paceman includes a tweeter and a midrange speaker in each of the rear side panels.

3 BLUETOOTH/USB.



4. Basic Bluetooth telephone preparation with USB audio interface



5. Full Bluetooth telephone preparation with USB audio

4. The standard **Basic Bluetooth telephone preparation with USB audio interface** connects wirelessly to Bluetooth-enabled mobile phones. The USB audio interface supports the connection of a device such as an iPod, USB memory stick or MP3 player. Users can select tracks stored on the device by album, artist, genre etc. via the radio or central display.¹

5. The optional **Full Bluetooth telephone preparation with USB audio interface** also includes a centre armrest and a three-spoke sports leather steering wheel with multi-function option and cruise control. With a snap-in adapter, available for a cost from your MINI Dealer, a Bluetooth-enabled mobile can be plugged in to a slot in the armrest, which charges its battery, and connects it to the vehicle aerial for improved reception. In conjunction with the optimal MINI Radio Visual BOOST you can use many of the functions on your smartphone, such as Bluetooth audio streaming and album cover artwork display, easily and safely on the radio display.^{1,2}

4 NAVIGATION SYSTEM.



The optional **MINI navigation system** turns the MINI Radio Visual BOOST into a powerful navigation solution, with navigation instructions given via voice prompts and on-screen arrows and maps. It also includes day and night modes, a search function for points of interest, TMC reception via a double tuner, a GPS aerial and support for updates via the USB interface.¹

¹ For information on the compatibility of devices for audio, video and telephone functions, visit: MINI.com/connectivity

² Subject to availability of device-specific snap-in adapters.

ENTERTAINMENT AND COMMUNICATIONS.

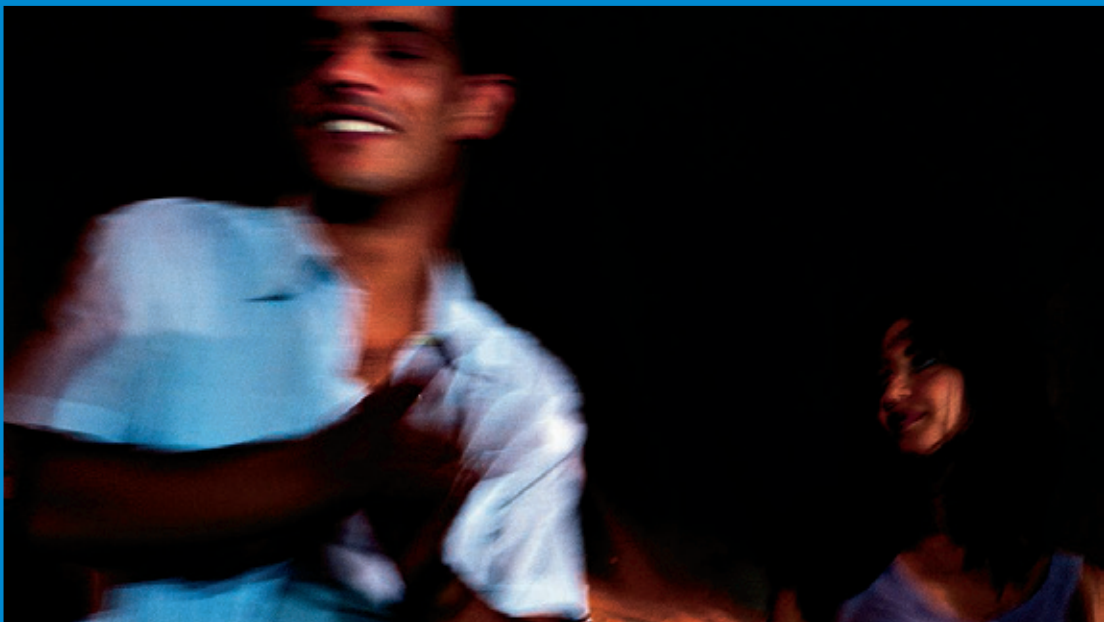

The **main menu** is located on the central display of your MINI, and displays the full range of infotainment options. All you have to do is choose how you'd like to be entertained.



One highlight is the **Driving Excitement** function, which includes a digital sport display and analyses how sporty and accurate your driving style is, further ratcheting up the fun.



International **web radio** with MINI Connected: select from thousands of stations. Wherever you happen to be, you're guaranteed to find something to please.



Driving Excitement
MINIMALISM Analyser
Dynamic Music
Mission Control
Web radio
Send to car
Google™ Search
Facebook
foursquare
Twitter
Calendar
News

5 MINI CONNECTED.

Full speed ahead on the information super-highway: **MINI Connected** revolutionises the world of in-car infotainment, seamlessly linking car and driver with the online world. An all-new USB interface seamlessly integrates the sophisticated features of your iPhone (not supplied) into the audio and infotainment system of your MINI. Information and contents appear on the central display in typical MINI style and are controlled via either the MINI joystick or the three-spoke sports leather steering wheel with multi-function option. The MINI Connected iPhone app allows you to connect to foursquare, Facebook and Twitter, or to get the latest news via RSS feeds. And best of all, soon you'll be able to check how sporty your driving is with the new Driving Excitement Analyser.^{1,2,3}

¹ Additional optional equipment required.

² Availability and range of features are dependent on the other equipment fitted, and may vary from country to country. Range and graphic design of MINI Connected functions subject to change without notice. Broadband mobile Internet access required. Costs resulting from this (e.g. data roaming) will be payable as specified in the contract with your network provider.

MINI Connected app available free of charge from the device manufacturer's app store (subject to national restrictions). Updates available free of charge, but version upgrades may be chargeable. If further MINI Connected-compatible apps become available, these will be identified/promoted accordingly. For more information about device compatibility and the functions contained in MINI Connected, visit MINI.com/connectivity.

³ iPhone 5 connectivity to be confirmed during 2013.

**MINI EQUIPMENT
PACKAGES.**

MINI EQUIPMENT PACKAGES.

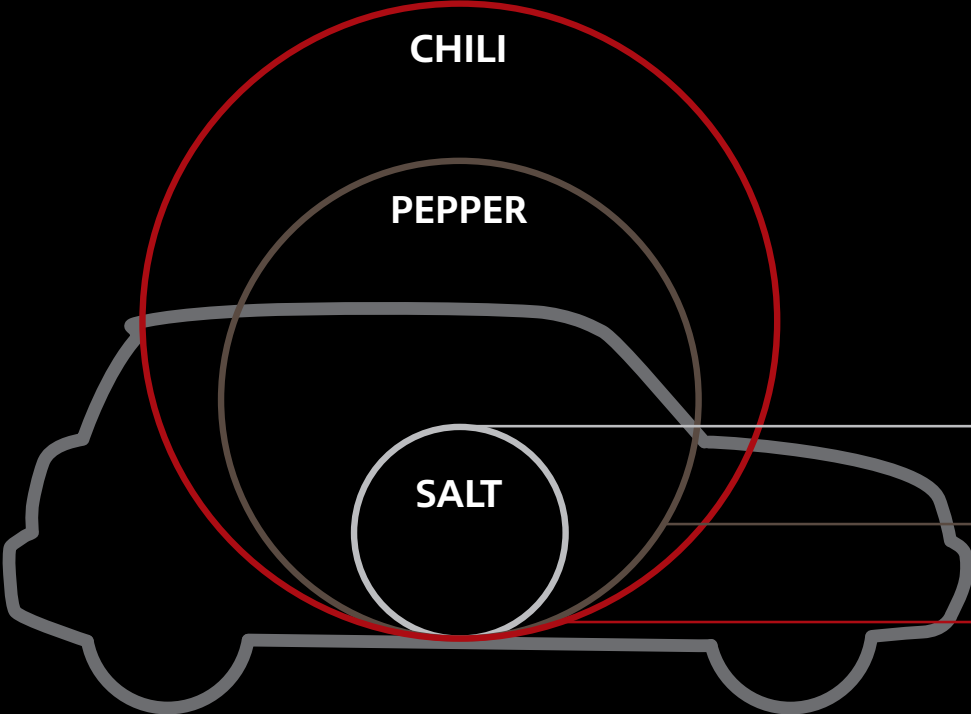

SPICE UP YOUR MINI.

Get more out of your MINI: the SALT, PEPPER and CHILI packages offer three stylish trim options, each with varying levels of comfort.

SALT.

Add a little flavour to your MINI with the SALT package. The features in this entry-level solution range from foot mats in velour to the Interior Lights Pack with Ambient Lighting. It's a great way of increasing comfort for everyone on board.

PEPPER.

The PEPPER package brings a little more to the table. Additional options include the rain sensor and automatic air conditioning, and mean the MINI can handle all weather conditions with ease.

CHILI.

Spice up your MINI even more. In addition to the features included in the PEPPER package, CHILI offers bi-xenon headlights (for Cooper S/SD and MINI John Cooper Works models), cloth/leather seats and larger light-alloy wheels. So however much things may heat up, you'll never lose your cool.

**JOHN COOPER
WORKS.**

MINI JOHN COOPER WORKS COUNTRYMAN.



GRAVEL? MUD? SHARP BENDS? ALL IN A DAY'S WORK!

The ALL4 all-wheel drive system distributes the impressive output of the MINI John Cooper Works Countryman to the front and rear axles as required, with up to 50% of engine torque being directed to the rear axle. In challenging situations, such as icy or snowy conditions, the torque is distributed to the wheels which have the best grip, thereby ensuring optimal traction, stability and safety.

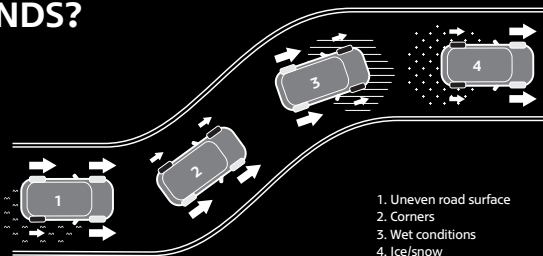

1. Uneven road surface
2. Corners
3. Wet conditions
4. Ice/snow

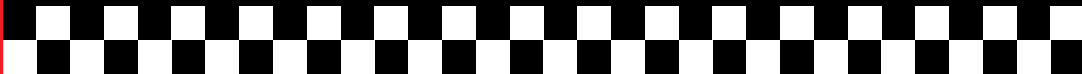

ADRENALIN TO GO.



A TREAT FOR THE EYES AND THE EARS.

The throaty sound of the twin-pipe sports exhaust with its striking, tailpipes is music to the ears of any motorsport enthusiast. And drivers will love feasting their eyes on the standard John Cooper Works aerodynamic package with modified front and rear bumpers, striking side skirts and track-style air intakes.



MINI JOHN COOPER WORKS PACEMAN.

PERFORMANCE ART.

Viewed from the outside, the MINI John Cooper Works Paceman blends the motorsport prowess of John Cooper Works models with the coupé lines of the MINI Paceman. Beneath the bonnet, it's all about John Cooper Works: The vehicle boasts the most powerful MINI engine currently available, with a high-tech twin-scroll turbocharger, direct fuel injection, variable valve control and incredible fuel economy for the level of performance offered. Press down firmly on the accelerator and overboost kicks in, adding an extra 20 newton-metres of torque to deliver up to 300 newton-metres in total, while the ALL4 all-wheel drive system, fitted as standard, ensures the vehicle's exceptional power is matched by impeccable traction.





PERFORMANCE GRAPH

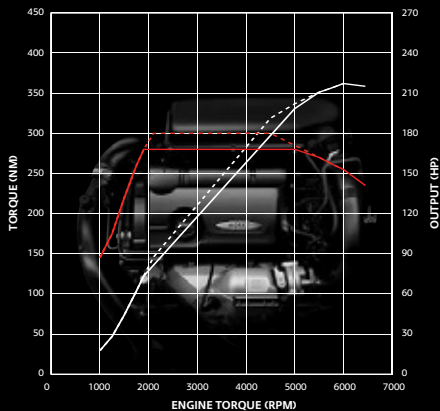

POWER PLAY.

Take a moment to absorb your surroundings while the lights are on red. Tighten your grip on the non-slip 3-spoke sports leather steering wheel, featuring the John Cooper Works badge and contrast stitching in Chili Red, and steal a glance at the stylish instruments with dials in Anthracite. Watch the tachometer needle twitching in anticipation and take a glimpse at the Chili Red stitching on the gear lever knob and gaiter – a subtle hint at what the powerful turbo engine under the bonnet has to offer. When the lights turn green, release the clutch and feel the power of the engine pressing you against the sport seat – a welcome reminder that there's no better car to put the city streets to the test at night.

OUTPUT ———
 TORQUE ———
 OVERBOOST - - - -

**JOHN COOPER WORKS
TUNING.
GENUINE MINI
ACCESSORIES.**

JOHN COOPER WORKS TUNING.



MINI Cooper S Countryman and MINI Cooper S Paceman with John Cooper Works Tuning



19" Double Spoke R129 in Burnished Black

Sports steering wheel in Alcantara

Sports silencer in Chrome



A powerful look, striking design and improved performance reflect the proud racing heritage of **John Cooper Works Tuning**¹. So you shouldn't find it difficult to make your MINI Countryman or MINI Paceman look even more fierce. A great way to do this is to kit it out with the design package in Chili Red (comprising side stripes, mirror caps and brake air duct in fiery Chili Red). The sporty personality really comes to the fore with various types of light-alloy wheels, available in Matt Black or Burnished Black,

and you can make the car look even more powerful with the sports silencer in Chrome. The interior John Cooper Works components are just as eye-catching. For example, the sports steering wheel in Alcantara with Carbon trim looks as good as it feels. With John Cooper Works Tuning, your MINI Countryman or MINI Paceman will deliver a genuine racetrack experience.

¹ For more information, visit MINI.co.uk/accessories

GENUINE MINI ACCESSORIES.



MINI Cooper S Countryman and MINI Cooper Paceman with Genuine MINI Accessories



Rail-Box with Care Tissues Box



All-weather floor mats



Aluminium rear-mounted rack

With **Genuine MINI Accessories**¹, you really can take absolutely everything with you: available accessories include the lockable aluminium rear-mounted rack for transporting two bicycles – where the tailgate can also be opened when the rack is fully loaded – and the surfboard holder made of impact-resistant plastic with built-in mast holder. Of course, smaller items can be stowed away nicely too.

The Rail-Box is a practical universal box for the interior with 1.5-litre capacity. You can safely store all sorts of things in it, such as a glasses case, wallet or mobile. And the little ones have one too in the MINI junior seat I-II, which is fitted with a height and tilt-adjustable back and a restraint cushion. You can make the footwell even more comfortable with the hard-wearing all-weather floor mats, available as a two or four-piece set for the front and/or rear in Black, either with the MINI logo or MINI Cooper S lettering.

**CONCEPT
AND SAFETY.
MINI DATA.**

CONCEPT AND SAFETY.

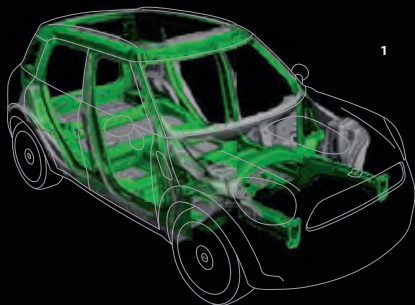

1

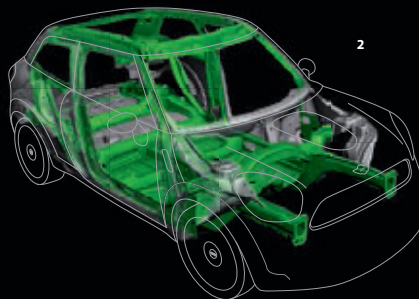

2

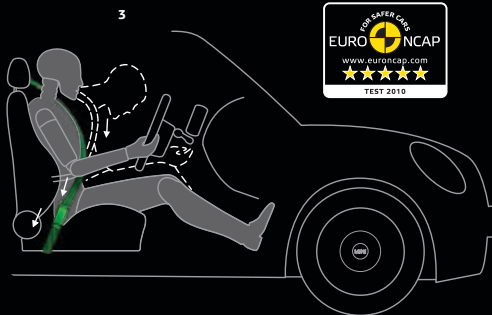

3



1.+2. BODY. The body of the MINI Countryman and the MINI Paceman has been reinforced at strategic points, guaranteeing extreme torsional rigidity for an exceedingly robust passenger compartment that delivers the perfect combination of comfort, acoustics and protection.

SUSPENSION. The combination of a single-joint spring-strut front axle and a multiple-control-arm rear axle with wide track and a low centre of gravity results in the unmistakable MINI feeling: stable, agile, with optimum cornering ability at all speeds, plus superb traction and outstanding safety.

3. RESTRAINT SYSTEM. A combination of three-point belts, belt tensioners and belt force limiters means driver and front-seat passenger enjoy the best possible protection in the event of a crash.

ISOFIX. To ensure the safety of younger passengers, the standard ISOFIX mountings in the rear allow one or two child seats to be attached.

EURO NCAP CRASH TEST. In the Euro NCAP crash test, the MINI Countryman scored a maximum of five stars. The level of protection for the occupants was rated as excellent in front, side and pole impacts, and the car also received outstanding scores for child safety.

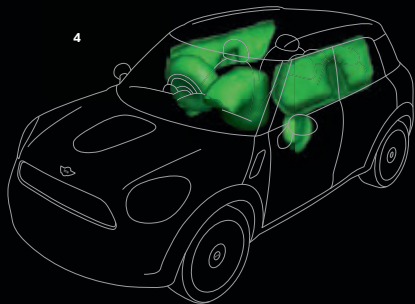

4

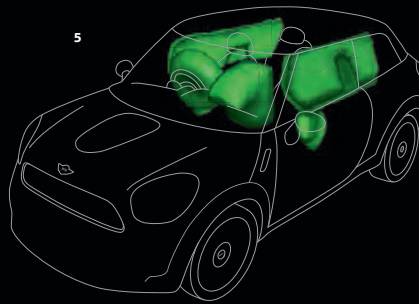

5

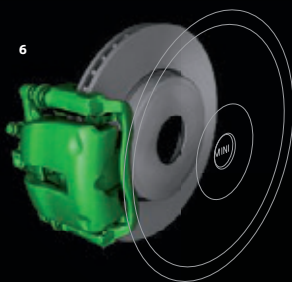

6

4. +5. AIRBAGS. The MINI Countryman and the MINI Paceman are fitted with six airbags as standard: driver and front passenger airbags protect the head and upper body in the event of a head-on collision, while side and head airbags are primarily designed to reduce the risk of injuries to the head, chest and abdominal areas from side impacts.

6. BRAKING SYSTEM. Four disc brakes with Anti-lock Braking System (ABS) and Cornering Brake Control (CBC) as standard ensure optimum braking performance in any situation. Electronic Brakeforce Distribution (EBD) manages the distribution of braking force between the front and rear axles. Brake assist also supports this process, to deliver maximum braking force and ensure the shortest possible stopping distances.

DYNAMIC BRAKE LIGHTS. Alerts following drivers to dangerous situations faster. Under normal braking the light comes on in the conventional way, but when the car performs an emergency braking manoeuvre, it starts to flash. In this way, it enables the traffic behind to see straight away how hard you are braking. Automatic activation of the hazard warning lights also lessens the risk of an impact from behind.

OVERBOOST FUNCTION. Performance can be a safety feature in itself. That's why the MINI Cooper S Countryman and MINI Cooper S Paceman are able to boost their maximum torque temporarily from 240 to 260 newton-metres, thanks to a system that momentarily increases the turbo pressure and the quantity of fuel injected in their 1.6-litre twin-scroll turbocharged engines. And more power means overtaking distances are shorter, and therefore safer.

CONCEPT AND SAFETY.

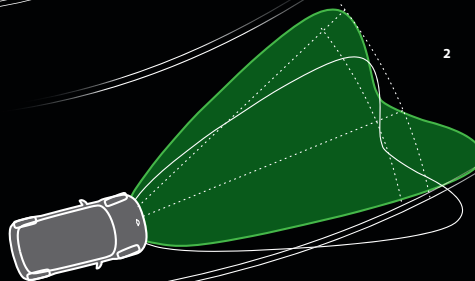
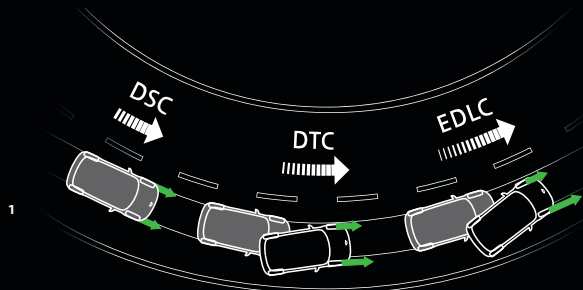

1. **DSC AND DTC.** Fitted as standard, **DYNAMIC STABILITY CONTROL (DSC)** counteracts incipient loss of grip by intervening in the engine management and applying braking force to individual wheels at the front and rear as necessary. DSC also includes Hill Assist which prevents the cars from rolling backwards on slopes.

The optional **DYNAMIC TRACTION CONTROL (DTC)** with **Electronic Differential Lock Control (EDLC)** gives drivers the option to make more use of the car's natural handling, by delaying interventions in engine management and braking until the last possible moment – although should the inner wheel lose too much traction, EDLC will apply braking to it, ensuring the car maintains forward momentum

through corners and on surfaces with variable levels of grip. At the same time, it enables more torque to be applied to the outer wheel. Braking interventions on the rear axle also help the car to hold its line when cornering.

2. **ADAPTIVE HEADLIGHTS.** This system, featuring automatic headlight beam-throw control, ensures optimum illumination whether driving in city or country, and allows drivers to see further ahead on the motorway. Sensors measure the steering angle, rate of turn and vehicle speed, and electric motors then adjust the position of the light beam accordingly to suit the speed and direction of the car (only available in conjunction with bi-xenon headlights).

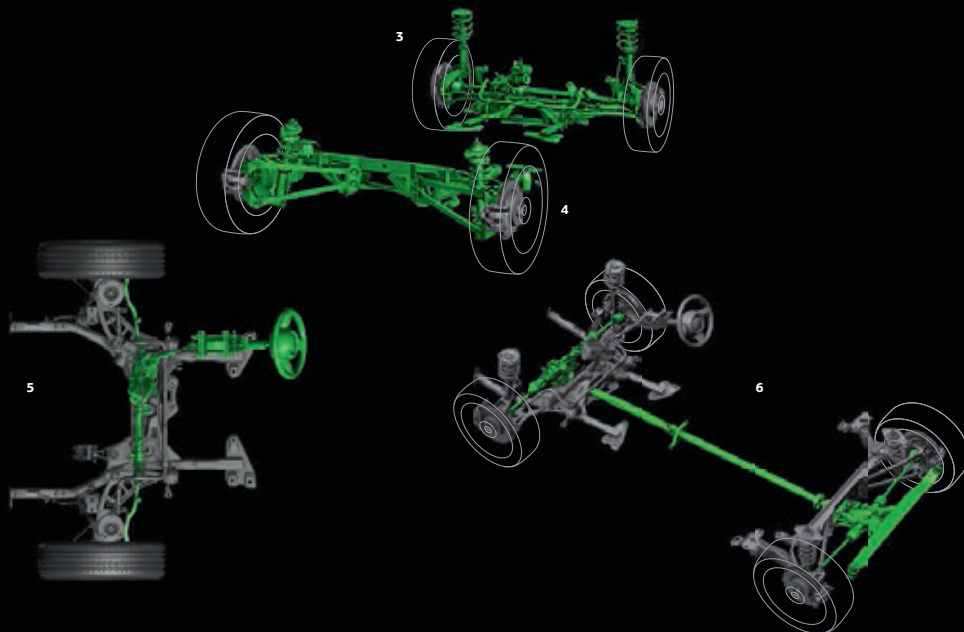

3. SINGLE-LINK SPRING-STRUT FRONT AXLE. Two drive shafts of equal length in the front suspension minimise the extent to which the drive train interferes with the steering, and optimise the car's cornering, acceleration and braking.

4. MULTI-LINK REAR AXLE. This sophisticated axle design ensures optimum contact between the wheels and the road, for the best possible traction. The aluminium construction keeps weight to a minimum and increases the agility of your MINI Countryman or MINI Paceman.

5. RACK-AND-PINION STEERING. Electric power assist ensures outstanding steering responses, with the driver receiving precise and involving feedback. The stiffness of the steering wheel adjusts to the speed of the car, for easier manoeuvrability at low speeds and smoother direction changes when travelling faster. For maximum comfort, it is only 2.4 turns from lock to lock.

6. ALL4. The ALL4 all-wheel drive system distributes the power of the engine between front and rear axles depending on the level of grip. In normal situations, a multi-disc clutch directs up to 50 per cent of the engine torque to the rear axle as required, but if necessary – for instance when driving on snow or ice – this figure can rise to 100 per cent. The result is optimum traction, grip and safety at all times.

CONCEPT AND SAFETY.

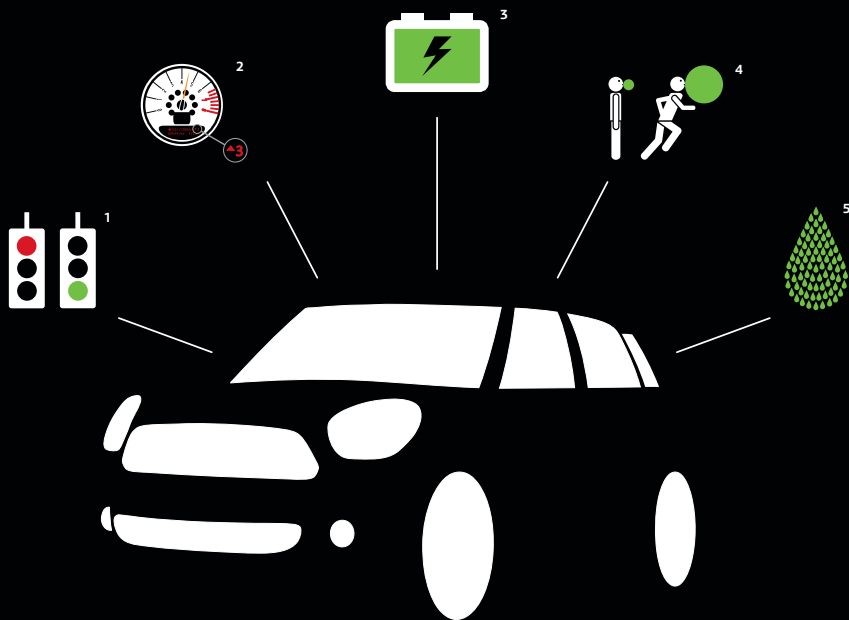

MINIMALISM. LESS IS MORE. Cutting out the fumes needn't mean cutting out the fun. This is made possible by a range of innovative MINIMALISM technologies fitted to all MINI Countryman and Paceman models.

1. AUTOMATIC START/STOP FUNCTION. The Automatic Start/Stop function (manual gearbox only) means that when the engine is idling – for example, at a red light or in a traffic jam – it is automatically switched off. As soon as the clutch pedal is depressed, the engine is re-started.

2. SHIFT POINT DISPLAY. The Shift Point Display (manual gearbox only) tells you via information displayed in the rev counter what gear you should be in to maximise fuel economy, reducing your emissions and your expenditure on fuel.

Full details of fuel consumption can be found in the Technical Data section. Figures quoted do not apply to vehicles with automatic transmission or ALL4.

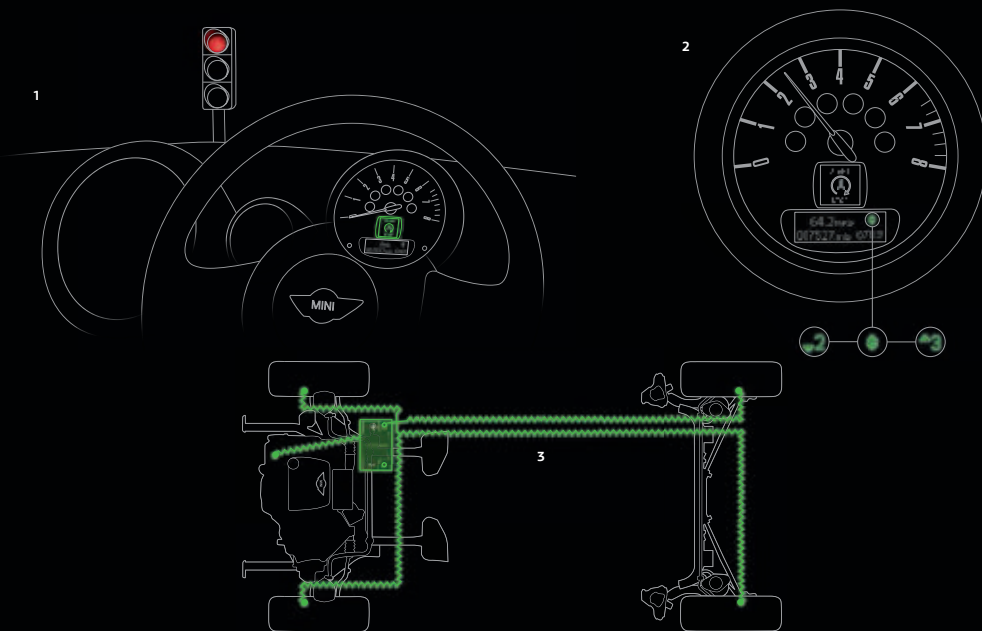

3. BRAKE ENERGY REGENERATION. Brake Energy Regeneration uses Intelligent Alternator Control to convert unneeded kinetic energy into electricity. When the driver's foot is not on the gas, more energy is diverted to charging the battery than when the car is under acceleration. So utilising energy which would be otherwise wasted.

4. FULLY VARIABLE VALVE TIMING. Fully variable timing of intake valve lift in the engine, increases power output while simultaneously improving the efficiency of combustion. On all models with petrol engines.

5. COMMON-RAIL TECHNOLOGY. High-pressure injection at a consistent 1,600 bar and multiple pre-injections ensure the diesel enters the cylinder as a fine mist, which makes the engine run more quietly and improves both output and fuel economy.

The **MINIMALISM ANALYSER**.¹ Part of the optional MINI Connected infotainment system (see the "Technology and equipment. Entertainment and communications" section for more details), the MINIMALISM Analyser monitors a number of variables to determine how economically you are currently driving, and gives you advice on how you could use less fuel. After each journey, you can review and compare your driving data with the user-friendly MINI Connected app, and refine your driving style for even greater fuel-efficiency.

¹For more information on MINI Connected, see pages 68–69.

TECHNICAL DATA.

ENGINE ^{1,2}		MINI ONE COUNTRYMAN	MINI ONE D COUNTRYMAN	MINI COOPER COUNTRYMAN	MINI COOPER D COUNTRYMAN	MINI COOPER S COUNTRYMAN	MINI COOPER SD COUNTRYMAN
Cylinders/layout/valves per cylinder		4/in-line/4	4/in-line/4	4/in-line/4	4/in-line/4	4/in-line/4	4/in-line/4
Displacement	cm ³	1598	1598	1598	1598 [1995]	1598	1995
Stroke/bore	mm	85.8/77.0	83.6/78.0	85.8/77.0	83.6/78.0 [90.0/84.0]	85.8/77.0	90.0/84.0
Max. output/max. revs	hp (kW)/rpm	98(72)/6000	90(66)/4000	122(90)/6000	112(82)/4000	184(135)/5500	143(105)/4000
Max. torque/revs	Nm/rpm	153/3000	215/1750–2500	160/4250	270/1750–2250	240/1600–5000 (260/1700–4500) ³	305/1750–2700
Compression ratio/recommended fuel	:1	11.0/91–98 RON	16.5/diesel	11.0/91–98 RON	16.5/diesel	10.5/91–98 RON	16.5/diesel
PERFORMANCE¹							
Max. speed	mph km/h	107 [104] 173 [168]	106 170	118 [113] 190 [182]	115 [112] 185 [180]	134 [130] 215 [210]	123 [121] 198 [195]
Acceleration 0–62 mph (0–100 km/h)	sec	11.9 [13.9]	12.9	10.5 [11.6]	10.9 [11.3]	7.6 [7.9]	9.3 [9.5]
Acceleration 50–75 mph (80–120 km/h) (4th/5th gear)	sec	13.9/17.9	12.5/15.9	11.6/14.9	9.7/11.9	7.1/8.6	7.9/10.1
FUEL CONSUMPTION^{1,2}							
Urban	mpg l/100 km	38.7 [30.4] 7.3 [9.3]	60.1	38.2 [30.4] 7.4 [9.3]	60.1 [39.2] 4.7 [7.2]	37.7 [29.7] 7.5 [9.5]	54.3 [38.7] 5.2 [7.3]
Extra-urban	mpg l/100 km	54.3 [47.1] 5.2 [6.0]	67.3 4.2	54.3 [47.1] 5.2 [6.0]	67.3 [60.1] 4.2 [4.7]	52.3 [49.6] 5.4 [5.7]	65.7 [58.9] 4.3 [4.8]
Combined	mpg l/100 km	47.1 [39.2] 6.0 [7.2]	64.2 4.4	47.1 [39.2] 6.0 [7.2]	64.2 [50.4] 4.4 [5.6]	46.3 [39.8] 6.1 [7.1]	61.4 [49.6] 4.6 [5.7]
CO ₂ emissions (combined cycle)	g/km	139 [168]	115	140 [168]	115 [149]	143 [166]	122 [150]
Tank capacity, approx.	l	47	47	47	47	47	47
Range	miles	488 [407]	665	488 [407]	665 [522]	478 [410]	634 [513]
WEIGHT¹/LUGGAGE CAPACITY¹							
Unladen weight (EU)*	kg	1340 [1370]	1385	1340 [1370]	1385 [1410]	1385 [1410]	1395 [1420]
Max. permitted weight	kg	1775 [1805]	1820	1775 [1805]	1820 [1845]	1820 [1845]	1830 [1855]
Max. permitted load	kg	510	510	510	510	510	510
Max. permitted axle load, front/rear	kg	935/880 [965/880]	995/880	930/880 [960/880]	985/880 [1005/880]	960/880 [980/880]	995/880 [1015/880]
Max. permitted towing weight, braked (max. gradient 12%)	kg	–	–	[1000]	800 [1200]	750 [1000]	800 [1200]
Luggage capacity	l	350/450–1170	350/450–1170	350/450–1170	350/450–1170	350/450–1170	350/450–1170
Length/width ⁴ /height ⁴	mm	4097/1789/1561	4097/1789/1561	4097/1789/1561	4097/1789/1561	4110/1789/1561	4110/1789/1561
WHEELS							
Tyre dimensions, front/rear		205/60 R16 92H	205/60 R16 92H	205/60 R16 92H	205/60 R16 92H	205/55 R17 91V	205/55 R17 91V
Wheel dimensions, front/rear		6.5 J x 16 steel	6.5 J x 16 steel	6.5 J x 16 alloy	6.5 J x 16 alloy	7.0 J x 17 alloy	7.0 J x 17 alloy

¹ All figures relate to vehicles with the standard six-speed manual gearbox. Figures in square brackets relate to vehicles with six-speed Automatic Transmission Steptronic.

² All MINI Countryman models comply with the EU5 exhaust emissions standard. Fuel consumption is determined in accordance with the EC driving cycle (as defined in Directive 80/183/EEC), made up of approximately one third urban and two thirds extra-urban driving (based on the distance covered). CO₂ emissions are measured separately from fuel consumption. Figures relate to standard-specification vehicles, and may vary significantly where optional equipment (including wider tyres) is fitted.

³ With overboost function.

⁴ The figure quoted includes a 90% tank filling, 68 kg for the driver and 7 kg for luggage. Unladen weight applies to vehicles with standard equipment. Optional equipment may increase this figure.

⁵ Not including mirrors.

⁶ Not including antenna/fins.

**MINI COOPER D
COUNTRYMAN
ALL4**

4/in-line/4
1598 [1995]
85.6/78.0 [90.0/84.0]
112(82)/4000
270/1750–2250
16.5/diesel

112 [109] 180 [175]
11.6 [11.8]
10.6/12.9

53.3 [37.2] 5.3 [7.6]
60.1 [56.5] 4.7 [5.0]
57.6 [47.1] 4.9 [6.0]
129 [158]
47
597 [488]

1455 [1480]
1890 [1915]
510
1010/930 [1030/930]
800 [1200]
350/450–1170
4097/1789/1561

205/60 R16 92H
6.5 J x 16 alloy

**MINI COOPER S
COUNTRYMAN
ALL4**

4/in-line/4
1598
85.8/77.0
184(135)/5500
240/1600–5000 (260/1700–4500) ³
10.5/91–98 RON

130 [127] 210 [205]
7.9 [8.3]
7.2/9.4

34.4 [27.4] 8.2 [10.3]
48.7 [45.6] 5.8 [6.2]
42.2 [36.7] 6.7 [7.7]
157 [180]
47
435 [379]

1455 [1480]
1890 [1915]
510
990/930 [1010/930]
750 [1000]
350/450–1170
4110/1789/1561

205/55 R17 91V
7.0 J x 17 alloy

**MINI COOPER SD
COUNTRYMAN
ALL4**

4/in-line/4
1995
90.0/84.0
143(105)/4000
305/1750–2700
16.5/diesel

121 [120] 195 [193]
9.4 [9.5]
8.5/10.7

53.3 [36.7] 5.3 [7.7]
60.1 [55.4] 4.7 [5.1]
57.6 [46.3] 4.9 [6.1]
130 [160]
47
597 [478]

1470 [1495]
1905 [1919]
510 [499]
1020/930 [1040/930]
800 [1200]
350/450–1170
4110/1789/1561

205/55 R17 91V
7.0 J x 17 alloy

**MINI JOHN
COOPER WORKS
COUNTRYMAN**

4/in-line/4
1598
85.8/77.0
218(160)/6000
280/1900–5000 (300/2100–4500) ³
10.5/91–98 RON

140 [139] 226 [224]
7.0 [7.0]
6.5/7.9

50.1 [26.4] 9.4 [10.7]
45.6 [44.8] 6.2 [6.3]
38.2 [35.8] 7.4 [7.9]
172 [184]
47
394 [369]

1480 [1505]
1915 [1940]
510
990/940 [1015/940]
–
350/450–1170
4133/1789/1549

225/45 R18 91V
7.5 J x 18 alloy

MINI.CO.UK/CONFIGURATOR



TECHNICAL DATA.

ENGINE ^{1,2}	MINI COOPER PACEMAN	MINI COOPER D PACEMAN (ALL 4)	MINI COOPER S PACEMAN (ALL 4)	MINI COOPER SD PACEMAN (ALL 4)	MINI JOHN COOPER WORKS PACEMAN
Cylinders/layout/valves per cylinder	4/in-line/4	4/in-line/4	4/in-line/4	4/in-line/4	4/in-line/4
Displacement	cm ³ 1598	1598 [1995]	1598	1995	1598
Stroke/bore	mm 85.8/77.0	83.6/78.0 [90.0/84.0]	85.8/77.0	90.0/84.0	85.8/77.0
Max. output/max. revs	hp(kW)/rpm 122(90)/6000	112(82)/4000	184(135)/5500	143(105)/4000	218(160)/6000
Max. torque/revs	Nm/rpm 160/4250	270/1750–2250	240/1600–5000 (260/1700–4500) ³	305/1750–2700	280/1900–5000 (300/2100–4500) ³
Compression ratio/recommended fuel	:1 11.0/91–98 RON	16.5/diesel	10.5/91–98 RON	16.5/diesel	10.5/91–98 RON
PERFORMANCE¹					
Max. speed	mph 119 [114] km/h 192 [184]	116 [113] [113 [110]] 187 [182] [182 [177]]	135 [132] [132 [129]] 217 [212] [212 [207]]	124 [122] [122 [121]] 200 [197] [197 [195]]	140 [139] 226 [224]
Acceleration 0–62 mph (0–100 km/h)	sec 10.4 [11.5]	10.8 [11.2] [11.5 [11.8]]	7.5 [7.8] [7.8 [8.2]]	9.2 [9.4] [9.3 [9.4]]	6.9 [6.9]
Acceleration 50–75 mph (80–120 km/h) (4th/5th gear)	sec 11.5/14.8	9.6/11.8 [10.5/12.8]	7.0/8.5 [7.1/9.3]	7.8/10.0 [8.4/10.6]	6.4/7.8
FUEL CONSUMPTION^{1,2}					
Urban	mpg 38.2 [30.4] l/100 km 7.4 [9.3]	60.1 [39.2] [53.5 [37.2]] 4.7 [7.2] [5.3 [7.6]]	37.7 [29.7] [34.4 [27.4]] 7.5 [9.5] [8.2 [10.3]]	54.3 [38.7] [53.5 [36.7]] 5.2 [7.3] [5.3 [7.7]]	30.1 [26.4] 9.4 [10.7]
Extra-urban	mpg 54.3 [47.1] l/100 km 5.2 [6.0]	67.3 [60.1] [60.1 [56.5]] 4.2 [4.7] [4.7 [5.0]]	52.3 [49.6] [48.7 [45.6]] 5.4 [5.7] [5.8 [6.2]]	65.7 [58.9] [60.1 [55.4]] 4.3 [4.8] [4.7 [5.1]]	45.6 [44.8] 6.2 [6.3]
Combined	mpg 47.1 [39.2] l/100 km 6.0 [7.2]	64.2 [50.4] [57.6 [47.1]] 4.4 [5.6] [4.9 [6.0]]	46.3 [39.8] [42.2 [36.7]] 6.1 [7.1] [6.7 [7.7]]	61.4 [49.6] [57.6 [46.3]] 4.6 [5.7] [4.9 [6.1]]	38.2 [35.8] 7.4 [7.9]
CO ₂ emissions (combined cycle)	g/km 140 [168]	115 [149] [129 [158]]	143 [166] [157 [180]]	122 [150] [130 [160]]	172 [184]
Tank capacity, approx.	l 47	47	47	47	47
Range	miles 488 [407]	665 [522] [597 [488]]	478 [410] [435 [379]]	634 [513] [597 [478]]	635 [595]
WEIGHT¹/LUGGAGE CAPACITY¹					
Unladen weight (EU) ⁴	kg 1330 [1360]	1375 [1395] [1445 [1470]]	1380 [1405] [1445 [1470]]	1390 [1410] [1465 [1490]]	1475 [1495]
Max. permitted weight	kg 1725 [1755]	1770 [1790] [1840 [1865]]	1775 [1800] [1840 [1865]]	1785 [1805] [1860 [1885]]	1870 [1890]
Max. permitted load	kg 470	470	470	470	470
Max. permitted axle load, front/rear	kg 910/840 [940/840]	960/840 [980/840] [990/890 [1015/890]]	955/840 [980/840] [970/890 [995/890]]	980/840 [1000/840] [1000/890 [1025/890]]	975/915 [995/915]
Max. permitted towing weight, braked (max. gradient 12%)	kg [1000]	800 [1200]	750 [1000]	800 [1200]	–
Luggage capacity	l 330–1080	330–1080	330–1080	330–1080	330–1080
Length/width ⁵ /height ⁶	mm 4109/1786/1518	4109/1786/1518	4115/1786/1522	4115/1786/1522	4124/1786/1527
WHEELS					
Tyre dimensions, front/rear	205/60 R 16 92H	205/60 R 16 92H	205/55 R17 91V	205/55 R17 91V	225/45 R18 91V
Wheel dimensions, front/rear	6.5 J x 16 alloy	6.5 J x 16 alloy	7.0 J x 17 alloy	7.0 J x 17 alloy	7.0 J x 18 alloy

¹ All figures relate to vehicles with the standard six-speed manual gearbox. Figures in square brackets relate to vehicles with six-speed Automatic Transmission Steptronic.

² All MINI Paceman models comply with the EU5 exhaust emissions standard. Fuel consumption is determined in accordance with the ECE driving cycle (as defined in Directive 80/1268/EEC), made up of approximately one third urban and two thirds extra-urban driving (based on the distance covered). CO₂ emissions are measured separately from fuel consumption. Figures relate to standard-specification vehicles, and may vary significantly where optional equipment (including wider tyres) is fitted.

³ With overboost function.

⁴ The figure quoted includes a 90% tank filling, 68 kg for the driver and 7 kg for luggage. Unladen weight applies to vehicles with standard equipment. Optional equipment may increase this figure.

⁵ Not including mirrors.

⁶ Not including antenna/finns.

DIMENSIONAL DRAWINGS.

MINI ONE/D COUNTRYMAN. MINI COOPER/D COUNTRYMAN. (MINI COOPER S/SD COUNTRYMAN.)

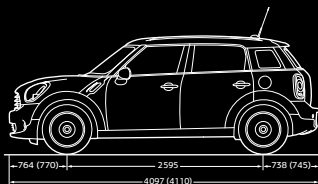
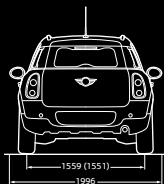
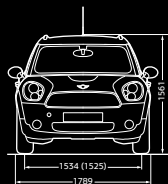

MINI JOHN COOPER WORKS COUNTRYMAN.

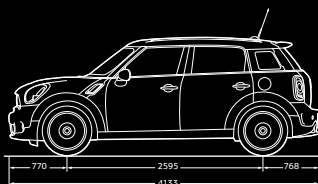
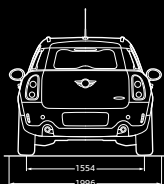
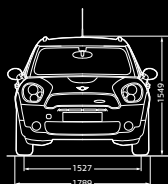

MINI COOPER/D PACEMAN. (MINI COOPER S/SD PACEMAN.)

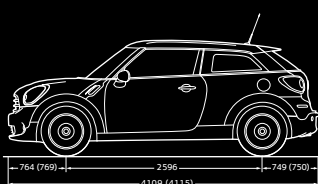
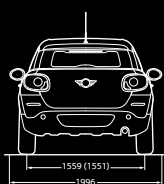
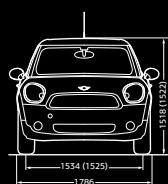

MINI JOHN COOPER WORKS PACEMAN.

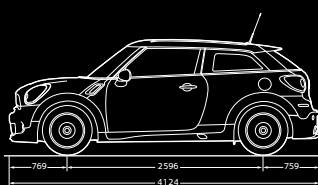
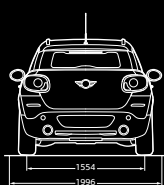
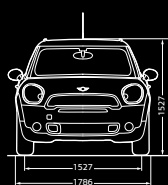

MINI SERVICE.



THE A TO Z OF SERVICE.

We provide everything that you and your MINI could ever need. Our highly trained specialists are ready, willing and able to tackle any challenge you present them with, small or large, without delay. They can diagnose and repair any electronic, mechanical, structural or cosmetic issues – right down to the smallest chip in the paintwork, everything can be fixed quickly and accurately, ensuring your MINI never loses its sparkle. And as you would expect, we only ever use Genuine MINI Parts – because only they offer the quality, durability and exact fit needed to make sure that your MINI stays a MINI.

A MINI THINKS FOR ITSELF.

Because it's not just built for quality, but for ease of repair and maintenance too. With a MINI, fixed service intervals are a thing of the past, as the on-board Condition Based Service (CBS) system constantly monitors the status of the car to work out what servicing it needs and when – saving you both time and money.

MINI SERVICE INCLUSIVE.

Why risk any unwelcome surprises in the future? MINI Service Inclusive offers full peace of mind, thanks to the expertise of MINI Service specialists, the guaranteed use of Original MINI Parts and the knowledge that your MINI is always in the best possible hands. What's more, you don't have to rely on your local MINI dealer for assistance. Work can be carried out around the world, by any participating MINI Service Centre. To find out more, see www.MINI.com/serviceinclusive

A BREAKDOWN?

It's unlikely, we know. But working on the basis that anything can happen, MINI Emergency Service is never more than a phone call away, 24 hours a day, 365 days a year. Specially trained MINI technicians will leave no stone unturned to get your MINI moving again, either over the phone or by coming to you at the roadside. In addition, there is a range of other breakdown assistance services to help you complete your journey (details vary from country to country).

WE'VE GOT EVERYTHING COVERED.

MINI FINANCIAL SERVICES.

DON'T DREAM IT, DRIVE IT. MAKE IT HAPPEN, WITH MINI FINANCIAL SERVICES.

Admittedly, daydreaming about a MINI can be fun. Just not compared to actually driving one. And the right finance solution from MINI Financial Services can help you find the shortest route from dream to reality, in a way that is tailored to your lifestyle, your budget and the MINI model that you choose.

MINI Leasing, MINI Finance and MINI Select are three roads that all lead to the same destination – namely, making your dream of driving a MINI come true. All of them offer their own unique advantages, and speaking to your MINI Dealer will help you decide which one is right for you.

Once you've chosen the car and the finance deal, you'll be asking yourself if there's any way you can make the MINI experience even more exciting. Answer: no, of course not. But what you can do is protect against surprises of the wrong sort, by choosing an insurance solution that was made for MINI drivers. Because as well as finance, MINI Financial Services also offers a range of insurance products that are tailored to your exact needs and preferences.

Your next move? The best thing to do is to make an appointment at your local MINI dealership. The sales advisors there know every MINI Financial Services product inside out, and it's their job to help you make your MINI dream come true.¹

¹ For more information about MINI Financial Services, its leasing, finance and insurance products, and the companies through which these products are provided in your country, visit MINI.com or speak to your MINI Dealer. Products and services may vary from country to country.

WARRANTY. RECYCLING.

WARRANTY.

Every MINI is supplied with a two-year unlimited mileage dealer warranty. (This excludes wear-and-tear parts, for example brake pads.) Every MINI also comes with a 12-year anti-corrosion warranty, which covers the vehicle against rusting of the body panels. This warranty is dependent on any previous damage to the vehicle body or under-body (e.g. stone impact damage, scratches, dents, accident damage or other damage caused by environmental factors) having been correctly repaired in accordance with current MINI guidelines. The painted surfaces of the car are covered by a three-year warranty. This excludes any damage to painted surfaces caused by improper treatment or unforeseen environmental factors. The statutory rights of the consumer are unaffected.

RECYCLING.

At every stage, from design to disassembly, recycling is central to the MINI philosophy. For example, all the materials used in its manufacture were selected because they can be used in the most sustainable and environmentally friendly way possible. That way, every MINI can be efficiently and ecologically recycled when its driving days are finally done. We have been working on this approach since 1994 at the BMW Group Recycling and Disassembly Centre in Munich, the only facility of its kind. Your MINI Dealer will be pleased to advise you on the disposal of your old vehicle. Alternatively, more information on this subject can also be found at www.MINI.co.uk

MINI COUNTRYMAN AND MINI PACEMAN STANDARD AND OPTIONAL EQUIPMENT.





MINI Countryman
MINI Paceman

Standard ■ MINI One/D models
■ MINI Cooper/D models
■ MINI Cooper S/SD models
■ MINI John Cooper Works models

Optional □ MINI One/D models
□ MINI Cooper/D models
□ MINI Cooper S/SD models
□ MINI John Cooper Works models

MODELS		
COLOURS.	P. 30	
B15 Light White	■ ■ ■ ■ ■	■ ■ ■ ■ ■
B19 Light Coffee	■ ■ ■ ■ ■	
851 Chili Red		■ ■ ■ ■ ■
B63 Blazing Red metallic	□ □ □ □ □	□ □ □ □ □
B26 Oxford Green metallic	□ □ □ □ □	□ □ □ □ □
B12 Crystal Silver metallic	□ □ □ □ □	□ □ □ □ □
B60 Brilliant Copper metallic	□ □ □ □ □	□ □ □ □ □
B14 True Blue metallic	□ □ □ □ □	
B11 Absolute Black metallic	□ □ □ □ □	□ □ □ □ □
B48 Royal Grey metallic	□ □ □ □ □	□ □ □ □ □
B13 Cosmic Blue metallic	□ □ □ □ □	
B62 Starlight Blue metallic		□ □ □ □ □
Bonnet stripes in White	□ □ □ □ □	□ □ □ □ □
Bonnet stripes in Black	□ □ □ □ □	□ □ □ □ □
Exterior mirror caps in Matt Black	■	
Exterior mirror caps in body colour	□ ■ ■ ■ ■	■ ■ ■ ■ ■
Exterior mirror caps, Chrome-plated	□ □ □ □ □	□ □ □ □ □

WHEELS.	P. 34	
16" steel wheels incl. hubcaps	■	
16" 5-Star Single Spoke, Silver	□ ■ ■ ■ ■	■ ■ ■ ■ ■
17" 5-Star Double Spoke, Silver	□ □ ■ ■ ■	□ □ ■ ■ ■
17" 5-Star Double Spoke, Black	□ □ □ □ □	□ □ □ □ □
17" 5-Star Double Spoke, Matt Anthracite	□ □ □ □ □	□ □ □ □ □
17" 5-Hole Black Star, Black		□ ■ ■ ■ ■
18" 5-Star Double Spoke Composite, Matt Anthracite	□ □ □ □ □	□ □ □ □ □
18" Turbo Fan, Silver	□ □ □ □ □	□ □ □ □ □
18" Turbo Fan, Matt White	□ □ □ □ □	□ □ □ □ □
18" 5-Star Double Spoke Composite, Black	□ □ □ □ □	□ □ □ □ □
18" Turbo Fan, Matt Anthracite	□ □ □ □ □	□ □ □ □ □
18" Twin Spoke Black, Black Burnished	■ ■ ■ ■ ■	■ ■ ■ ■ ■
19" Y-Spoke, Light Anthracite		□ □ □ □ □
19" Cross Spoke Crusher	□ □ □ □ □	□ □ □ □ □
EXTERIOR.	P. 38	
Chrome Line Exterior	□ □ □ □ □	□ □ □ □ □
Bi-xenon headlights	□ □ □ □ □	□ □ □ □ □
Adaptive Headlights	□ □ □ □ □	□ □ □ □ □
Black headlight reflectors	□ □ □ □ □	□ □ □ □ □
Rear lights with integrated rear fog light	■ ■ ■ ■ ■	■ ■ ■ ■ ■

		
White direction indicator lights	<input type="checkbox"/> <input type="checkbox"/> <input type="checkbox"/> <input type="checkbox"/>	<input type="checkbox"/> <input type="checkbox"/> <input type="checkbox"/>
Rear-mounted rack preparation	<input type="checkbox"/> <input type="checkbox"/> <input type="checkbox"/>	<input type="checkbox"/> <input type="checkbox"/>
Trailer tow hitch	<input type="checkbox"/> <input type="checkbox"/>	<input type="checkbox"/> <input type="checkbox"/>
Comfort Access system	<input type="checkbox"/> <input type="checkbox"/> <input type="checkbox"/> <input type="checkbox"/>	<input type="checkbox"/> <input type="checkbox"/> <input type="checkbox"/>
Glass sliding/vent roof	<input type="checkbox"/> <input type="checkbox"/> <input type="checkbox"/> <input type="checkbox"/>	<input type="checkbox"/> <input type="checkbox"/> <input type="checkbox"/>
Sun protection glazing	<input type="checkbox"/> <input type="checkbox"/> <input type="checkbox"/> <input type="checkbox"/>	<input type="checkbox"/> <input type="checkbox"/> <input type="checkbox"/>
Park Distance Control-Rear (PDC)	<input type="checkbox"/> <input type="checkbox"/> <input type="checkbox"/> <input type="checkbox"/>	<input type="checkbox"/> <input type="checkbox"/> <input type="checkbox"/>
ALL4 all-wheel drive ¹	<input type="checkbox"/> <input type="checkbox"/> <input type="checkbox"/>	<input type="checkbox"/> <input type="checkbox"/> <input type="checkbox"/>
Rear spoiler, MINI models	<input type="checkbox"/> <input type="checkbox"/>	
Rear spoiler, MINI Cooper S/SD models	<input type="checkbox"/> <input type="checkbox"/> <input type="checkbox"/> <input type="checkbox"/>	<input type="checkbox"/> <input type="checkbox"/> <input type="checkbox"/> <input type="checkbox"/>

INTERIOR.

P. 44

INTERIOR COLOURS

Carbon Black	<input type="checkbox"/> <input type="checkbox"/> <input type="checkbox"/> <input type="checkbox"/>	<input type="checkbox"/> <input type="checkbox"/> <input type="checkbox"/> <input type="checkbox"/>
Polar Beige	<input type="checkbox"/> <input type="checkbox"/> <input type="checkbox"/> <input type="checkbox"/>	

INTERIOR SURFACES

4DB Dark Silver	<input type="checkbox"/> <input type="checkbox"/>	<input type="checkbox"/>
Dark Anthracite	<input type="checkbox"/>	<input type="checkbox"/>
4BD Piano Black	<input type="checkbox"/> <input type="checkbox"/> <input type="checkbox"/> <input type="checkbox"/>	<input type="checkbox"/> <input type="checkbox"/> <input type="checkbox"/> <input type="checkbox"/>
4DC Black Chequered	<input type="checkbox"/> <input type="checkbox"/> <input type="checkbox"/> <input type="checkbox"/>	<input type="checkbox"/> <input type="checkbox"/> <input type="checkbox"/> <input type="checkbox"/>

COCKPIT SURFACES

4DB Dark Silver	<input type="checkbox"/> <input type="checkbox"/>	<input type="checkbox"/>
Dark Anthracite	<input type="checkbox"/>	<input type="checkbox"/>
4BD Piano Black	<input type="checkbox"/> <input type="checkbox"/> <input type="checkbox"/> <input type="checkbox"/>	<input type="checkbox"/> <input type="checkbox"/> <input type="checkbox"/> <input type="checkbox"/>

		
COLOUR LINES		
4C1 Carbon Black	<input type="checkbox"/> <input type="checkbox"/> <input type="checkbox"/> <input type="checkbox"/>	<input type="checkbox"/> <input type="checkbox"/> <input type="checkbox"/> <input type="checkbox"/>
4C4 Dark Tobacco	<input type="checkbox"/> <input type="checkbox"/> <input type="checkbox"/>	
4C2 Polar Beige	<input type="checkbox"/> <input type="checkbox"/> <input type="checkbox"/> <input type="checkbox"/>	
4C5 Pure Red	<input type="checkbox"/> <input type="checkbox"/> <input type="checkbox"/>	
4C3 Satellite Grey		<input type="checkbox"/> <input type="checkbox"/> <input type="checkbox"/> <input type="checkbox"/>
4EM Red Copper		<input type="checkbox"/> <input type="checkbox"/> <input type="checkbox"/> <input type="checkbox"/>



STEERING WHEELS

Two-spoke standard steering wheel	<input type="checkbox"/> <input type="checkbox"/>	<input type="checkbox"/>
Two-spoke leather steering wheel	<input type="checkbox"/> <input type="checkbox"/>	<input type="checkbox"/>
Three-spoke sports leather steering wheel	<input type="checkbox"/> <input type="checkbox"/> <input type="checkbox"/>	<input type="checkbox"/> <input type="checkbox"/> <input type="checkbox"/>
Three-spoke sports leather steering wheel with multi-function option	<input type="checkbox"/> <input type="checkbox"/> <input type="checkbox"/> <input type="checkbox"/>	<input type="checkbox"/> <input type="checkbox"/> <input type="checkbox"/> <input type="checkbox"/>

SEATS

Cloth standard seat	<input type="checkbox"/> <input type="checkbox"/>	
Cloth sport seat	<input type="checkbox"/> <input type="checkbox"/>	<input type="checkbox"/> <input type="checkbox"/> <input type="checkbox"/> <input type="checkbox"/>
Cloth/leather sport seat	<input type="checkbox"/> <input type="checkbox"/> <input type="checkbox"/> <input type="checkbox"/>	<input type="checkbox"/> <input type="checkbox"/> <input type="checkbox"/> <input type="checkbox"/>
Gravity leather sport seat	<input type="checkbox"/> <input type="checkbox"/> <input type="checkbox"/> <input type="checkbox"/>	<input type="checkbox"/> <input type="checkbox"/> <input type="checkbox"/> <input type="checkbox"/>
Lounge leather sport seat	<input type="checkbox"/> <input type="checkbox"/> <input type="checkbox"/> <input type="checkbox"/>	<input type="checkbox"/> <input type="checkbox"/> <input type="checkbox"/> <input type="checkbox"/>

		
UPHOLSTERY ²		
Cosmos cloth ³ APE1 Carbon Black/Light Tobacco	■ ■	
Diagonal Track cloth ³ BBE1 Carbon Black/Carbon Black	□ □ ■	■ ■
Diagonal Track cloth ³ BBP9 John Cooper Works/Carbon Black		■ ■
Parallel Lines cloth/leather ⁴ FSGZ Carbon Black/Light Tobacco	□ □ □ □	
Parallel Lines cloth/leather ⁴ FSGY Carbon Black/Pure Red	□ □ □ □	
Cloth/leather BFE1 Hot Cross		□ □ □
Gravity leather ^{4,5} T6E1 Carbon Black	□ □ □ □	□ □ □
Gravity leather ^{4,5} T6GK Satellite Grey		□ □ □
Gravity leather ^{4,6} T6GW Polar Beige	□ □ □ □	
Lounge leather ^{6,6} T9E1 Carbon Black	□ □ □ □	
Lounge leather ^{6,6} T9GX Light Coffee	□ □ □ □	
Lounge leather ^{6,6} T9IN Carbon Black Championship Red	□	□
Lounge leather ^{6,6} T9RX Red Copper		□ □ □
FURTHER FEATURES		
Chrome Line Interior	□ □ □ □ □	□ □ □
Short MINI Centre Rail	■ ■ ■ ■	
Full-length MINI Centre Rail	□ □ □ □	□ □ □
Two-part MINI Centre Rail	□ □ □ □	■ ■ ■
Rear seats, three-seat models	■ ■ ■ ■	
Rear seats, two-seat models	□ □ □ □	■ ■ ■
Split-folding rear seat backrest	■ ■ ■ ■	■ ■ ■
Removable flat load-compartment floor	□ □ □ □	□ □ □
Interior Lights Pack	□ □ □ □	□ □ □
Storage Compartment Pack	□ □ □ □	□ □ □

		
TECHNOLOGY AND EQUIPMENT. P. 60		
On-board computer	□ □ □ □	□ □ □
Rain sensor and automatic lights on	□ □ □ □	□ □ □
Exterior mirror package	□ □ □ □	□ □ □
Air conditioning	■ ■ ■ ■	■ ■ ■
Automatic air conditioning	□ □ □ □	□ □ □
Heated front windshield	□ □ □ □	□ □ □
Seat heating-front	□ □ □ □	□ □ □
Shift paddles on the three-spoke sports leather steering wheel	□ □ □ □	□ □ □
Six-speed Automatic Transmission Steptronic	□ □ □ □	□ □ □
ENTERTAINMENT AND COMMUNICATIONS. P. 64		
Radio MINI CD	■ ■ ■ ■	■ ■
MINI Radio BOOST CD	□ □ □ ■	□ □ ■
MINI Radio Visual BOOST	□ □ □ □	□ □ □
MINI navigation system	□ □ □ □	□ □ □
MINI Connected	□ □ □ □	□ □ □
harman/kardon hi-fi loudspeaker system	□ □ □ □	□ □ □
Basic Bluetooth hands-free kit with USB audio interface	□ □ □ □	□ □ □
Bluetooth mobile phone preparation with USB audio interface	□ □ □ □	□ □ □

		
JOHN COOPER WORKS.	P. 76	
Exterior colour U851 Chili Red	<input type="checkbox"/>	<input checked="" type="checkbox"/>
18" Twin Spoke, Black Burnished	<input checked="" type="checkbox"/>	<input checked="" type="checkbox"/>
19" Cross Spoke Crusher, Black	<input type="checkbox"/>	<input type="checkbox"/>
Three-spoke sports steering wheel with contrast stitching in Chili Red	<input checked="" type="checkbox"/>	<input checked="" type="checkbox"/>
T91N Lounge leather sport seat in Carbon Black Championship Red	<input type="checkbox"/>	<input type="checkbox"/>
Interior and cockpit surfaces 4CY Chili Red	<input type="checkbox"/>	<input type="checkbox"/>
Diagonal Track cloth ¹ BBP9 John Cooper Works/Carbon Black	<input checked="" type="checkbox"/>	<input checked="" type="checkbox"/>
Sport Stripes	<input checked="" type="checkbox"/>	<input checked="" type="checkbox"/>

**GENUINE MINI ACCESSORIES.
JOHN COOPER WORKS TUNING.**

P. 82

19" Double Spoke R129 in Burnished Black	<input type="checkbox"/> <input type="checkbox"/> <input type="checkbox"/> <input type="checkbox"/>	<input type="checkbox"/> <input type="checkbox"/>
Three-spoke sports steering wheel in Alcantara	<input type="checkbox"/> <input type="checkbox"/> <input type="checkbox"/> <input type="checkbox"/>	<input type="checkbox"/> <input type="checkbox"/>
Sports silencer in Chrome	<input type="checkbox"/> <input type="checkbox"/> <input type="checkbox"/> <input type="checkbox"/>	<input type="checkbox"/> <input type="checkbox"/>
Rail-Box with Care Tissues Box	<input type="checkbox"/> <input type="checkbox"/> <input type="checkbox"/> <input type="checkbox"/>	<input type="checkbox"/> <input type="checkbox"/>
All-weather floor mats	<input type="checkbox"/> <input type="checkbox"/> <input type="checkbox"/> <input type="checkbox"/>	<input type="checkbox"/> <input type="checkbox"/>
Aluminium rear-mounted rack	<input type="checkbox"/> <input type="checkbox"/> <input type="checkbox"/> <input type="checkbox"/>	<input type="checkbox"/> <input type="checkbox"/>

¹ Available for the MINI Cooper D Countryman, MINI Cooper S Countryman, MINI Cooper SD Countryman, MINI John Cooper Works Countryman, MINI Cooper D Paceman, MINI Cooper S Paceman, MINI Cooper SD Paceman and MINI John Cooper Works Paceman.

² With matching interior colour combinations.

³ Only for standard seat.

⁴ Only for sport seat.

⁵ Only for sport seat with piling.

⁶ Leather upholstery includes seats (base and backrest), and front and rear headrests.

All information concerning equipment and availability is subject to change and without any liability.

MINI.CO.UK/CONFIGURATOR

This link will take you straight to the online MINI configurator.

MARCH 2013

The models, standard and optional equipment and combinability of options in this brochure relate to cars supplied by BMW AG for the German market. The availability of standard and optional equipment, and the combinability of options, may vary from country to country within the European Union for all models. For detailed information about the situation in your country, please contact your authorised MINI Dealer. Subject to change in design and equipment.

© BMW AG, Munich, Germany. Not to be reproduced, wholly or in part, without written permission of BMW AG, Munich.

UK Part Number: 92.00.0.002.95B MARCH 2013

For more information, visit minico.uk or www.mini.ie



<http://www.facebook.com/MINIUK>
<http://www.MINIspace.com>



Follow us on Twitter
<http://www.twitter.com/MINIUK>



MINI YOUTUBE CHANNEL
<http://www.youtube.com/MINIUK>