



> View price list



> View offers



> SOUND WITH POWER



> Mercedes-Benz Magazine

CLA-Class



Mercedes-Benz





> View price list



> View offers



> SOUND WITH POWER



> Mercedes-Benz Magazine

Nothing cuts it like the CLA

Witness a revolution on the move. The Mercedes-Benz CLA combines 5-door practicality with breath-taking coupé styling. In fact, the design attracts a lot more than admiration. These determined, athletic lines provide the key to the CLA's unrivalled aerodynamics. And low air resistance, of course, benefits performance and fuel consumption. Inside, the bold theme continues with an equally exciting progressive feel. Any form of resistance will seem futile.





> View price list



> View offers



> SOUND WITH POWER



> Mercedes-Benz Magazine



Featured models at a glance:

4 | Mercedes-Benz CLA AMG Sport
Metallic Polar Silver

Optional AMG multi-spoke alloy wheels, Intelligent Light System

9 | Mercedes-Benz CLA AMG Sport
Non-metallic Jupiter Red

Standard AMG 5-twin-spoke alloy wheels, Intelligent Light System

14 | Mercedes-Benz CLA Sport
Metallic Polar Silver

Standard 5-twin-spoke alloy wheels in Himalaya Grey, diamond grille with black pins, single louvre in silver with chrome trim and beltline strips in chrome look

17 | Mercedes-Benz CLA45 AMG 4MATIC
Non-metallic Cirrus White

Standard AMG multi-spoke alloy wheels in matt black finish, AMG Night Package, AMG Performance seats, Black leather upholstery, AMG carbon fibre trim

Equipment options at a glance:

21 | Engines and suspension

29 | Safety

33 | Comfort

39 | AMG

47 | Equipment

64 | Services

66 | Facts and finishes



With an iPad® you can download the interactive CLA-Class brochure app either by scanning the QR code or by visiting the App Store

Illustrations may show accessories and items of optional equipment which are not part of the standard specification





> View price list



> View offers



> SOUND WITH POWER



> Mercedes-Benz Magazine

Overview 4

Chases the wind, not the competition



These fluid lines reveal pioneering aerodynamics, setting new standards in air resistance. Engraved in the headlamps is a burning desire for the tarmac. This Mercedes-Benz design moves the soul, even at a standstill.





> View price list



> View offers



> SOUND WITH POWER



> Mercedes-Benz Magazine

Common views reviewed



The CLA instantly attracts attention, then it throws out the rulebook. Taut profile, the rear hovering low over the tarmac – the expressive design adds a new sense of dynamics to the coupé shape. This Mercedes-Benz consciously sets itself apart, only to lead the way.





> View price list



> View offers



> SOUND WITH POWER



> Mercedes-Benz Magazine

Four cylinders, shaped like an arrow



Great departures need energy. The most refined engine technology impels the four cylinders to deliver maximum output. A 6-speed manual or a 7G-DCT 7-speed dual-clutch transmission channels the CLA's force directly onto the tarmac.





> View price list



> View offers



> SOUND WITH POWER



> Mercedes-Benz Magazine

The interior also defies convention – daring you to get inside. The dynamic air vents are reminiscent of jet turbines. The dashboard with twin-tube instrument cluster takes its cue from racing cars. Equally, the large tablet-style display instantly catches the eye. Stitching on the steering wheel, standard sports seats – the CLA makes its intentions crystal clear: it's raring to go.





> View price list



> View offers



> SOUND WITH POWER



> Mercedes-Benz Magazine

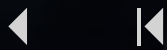



> View price list



> View offers



> SOUND WITH POWER



> Mercedes-Benz Magazine

Determined to challenge



Prepare to rattle the status quo: the AMG Sport makes a compelling impression with its striking diamond grille, AMG bodystyling all round and a twin-pipe exhaust system for a thrilling entrance.





> View price list



> View offers



> SOUND WITH POWER



> Mercedes-Benz Magazine





> View price list



> View offers



> SOUND WITH POWER



> Mercedes-Benz Magazine

A driving confession



Want to get closer to the action? Sports suspension on the CLA AMG Sport ensures you're 15 mm closer to the road. Taut dampers and Sports Direct Steering do their bit, responding to your every wish.

Availability of paint colour to be confirmed





> View price list



> View offers



> SOUND WITH POWER



> Mercedes-Benz Magazine





> View price list



> View offers



> SOUND WITH POWER



> Mercedes-Benz Magazine



An unconventional exterior needs a thought-provoking interior. Like Lava Black upholstered sports seats with red perforations and stitching as part of the AMG Exclusive Package. For a soundly athletic tactile experience, the AMG Sport also has a multi-function sports steering wheel in nappa leather complete with a perforated grip area and flattened lower section.





> View price list



> View offers



> SOUND WITH POWER



> Mercedes-Benz Magazine





> View price list



> View offers



> SOUND WITH POWER



> Mercedes-Benz Magazine

In charge





> View price list



> View offers



> SOUND WITH POWER



> Mercedes-Benz Magazine



When it comes to your protection, the CLA takes no shortcuts. A high-strength bodyshell, up to nine airbags, as well as innovative electronic safety assistants, are always at your side. Collision Prevention Assist, Adaptive Brake Assist with hold function plus Attention Assist also feature as standard. When it comes to enjoying the ride, rest assured there are no assistants required.





> View price list



> View offers



> SOUND WITH POWER



> Mercedes-Benz Magazine

Engineered to deliver 450 Nm-worth of goosebumps



Tap the accelerator and feel the 4-cylinder engine spring into action, pinning you firmly into the comfortable sports seat. This is the CLA45 AMG. A car that delivers 450 Nm of torque. And its fair share of excitement.





> View price list



> View offers



> SOUND WITH POWER



> Mercedes-Benz Magazine

Fewer cylinders. Less fuel. No compromise:
4 cylinders, 39.8 mpg, 360 hp (265 kW)



The CLA 45 AMG might be a born performer, but it's frugal at heart. You see, this indecently powerful 4-cylinder consumes only 39.8 mpg, making it really quite sensible. Though the rush of adrenalin might make you believe otherwise.





> View price list



> View offers



> SOUND WITH POWER



> Mercedes-Benz Magazine

Insight 19

Meet an aerodynamics champion: the design is his trophy

At first, the wind blows from the south, then from northeast. The speed: 90 miles per hour. Right there, in the eye of the storm, a star braves the elements. Unperturbed, an engineer traces the lines of the bonnet with his fingers. One of the delicate threads seemingly wrapped around the car suddenly lights up in a bright colour. Hurricane force winds now hit the grille. Yet, it's oddly quiet in here, as always in the Mercedes-Benz wind laboratory. After all, only the cars need to withstand these forces; the engineers take a back seat behind their monitors.

Now it's the CLA's turn to prove itself against all the odds. Aerodynamics require time and precision work. Every minute part of the car delivers results that are taken into account, calculated and optimised to be applied to the vehicle as a whole. For instance, comb-shaped spoilers in the wheel arches help control the air-flow around the wheels. Every thousandth less wind resistance makes a difference, increasing speed whilst reducing fuel consumption. Reducing drag by 0.01 means 0.1 litres less fuel per 60 miles. Or in other words: 230,000 hours in the virtual wind tunnel paired with plenty of precision work have turned the CLA into an aerodynamics champion.

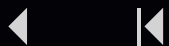



> View price list



> View offers



> SOUND WITH POWER



> Mercedes-Benz Magazine

The CLA in detail

Engines and suspension

- 21 | Mercedes-Benz Intelligent Drive and Mercedes-Benz Connect
- 23 | Diesel engines
- 24 | Petrol engines
- 25 | Transmission
- 26 | Suspension

Safety

- 27 | Integrated safety concept

Comfort

- 31 | Multimedia systems
- 33 | Electronic assistants
- 35 | Seats
- 36 | Light and Sight Package

AMG

- 37 | CLA 45 AMG 4MATIC exterior
- 39 | CLA 45 AMG 4MATIC interior
- 41 | CLA 45 AMG 4MATIC technology
- 43 | AMG Performance Studio

Equipment

- 45 | CLA Sport
- 49 | CLA AMG Sport
- 53 | Exclusive Package
- 55 | AMG Exclusive Package
- 57 | Standard equipment
- 58 | Optional extras
- 59 | Alloy wheels
- 60 | Retailer-fit accessories

Services

- 62 | Services

Facts and finishes

- 64 | Dimensions
- 65 | Technical data
- 67 | Paint finishes

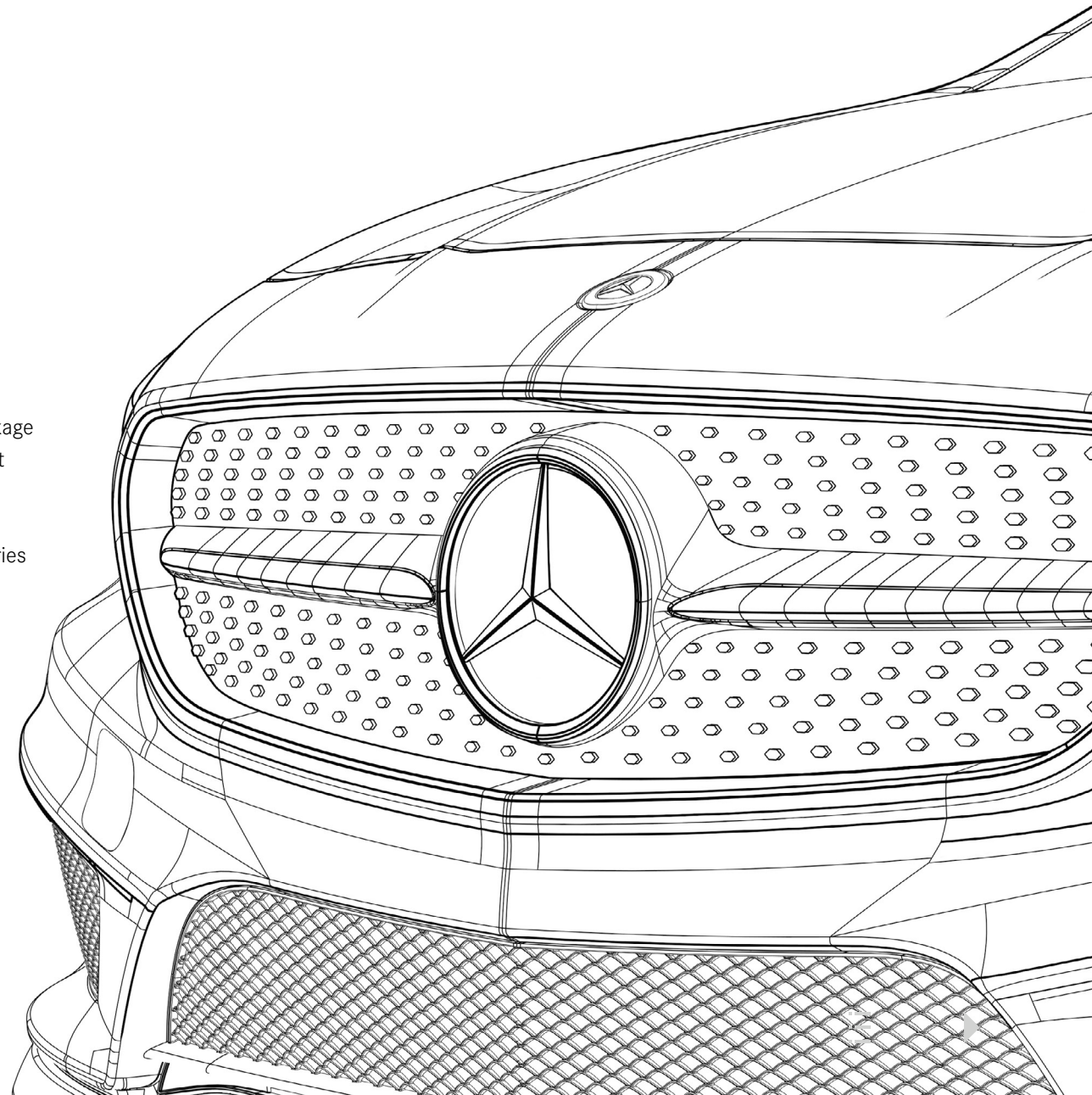



Connected with all the senses

With Mercedes-Benz Intelligent Drive and Mercedes-Benz Connect, we have taught our cars to think. It takes us one step closer to our vision of accident-free driving.

Our engineers live in the future, constantly aiming to turn innovative thinking into everyday solutions. This aspiration has resulted in many developments with a lasting impact on automotive engineering. In other words, our work ensures that a Mercedes-Benz is always ahead of its time.

Innovative technologies such as the Pre-Safe® anticipatory safety system and DISTRONIC Plus radar-assisted cruise control first made it onto the road in a Mercedes-Benz, setting new standards in vehicle safety. It marked the first time active and passive systems were combined – for even better protection and ride comfort. Time and time again we have pioneered solutions to get closer to realising our vision of accident-free driving.

Mercedes-Benz Intelligent Drive takes things a step further by intelligently combining sensors with safety systems and electronic assistants. For us, it's a logical progression as the traffic situation has changed. There are more vehicles on the road, the driver's job is becoming more complex and distractions are increasing.

Radar-assisted Cruise Control with Steering Assist and Stop & Go Pilot marks another important step towards autonomous driving. Steering Assist provides lateral assistance to keep the car in lane. It works with a stereo camera capturing road markings and vehicles driving ahead at low speeds. The system brakes if necessary and accelerates to a preset speed when possible. As a result, your driving comfort is significantly enhanced, especially on long journeys or in slow-moving traffic jams.

Mercedes-Benz Connect. Serving as a smart interface between car and Internet, Mercedes-Benz Connect offers a whole range of services for your comfort, safety and information. It's an effortless, highly efficient way to keep the driver connected with the digital world when on the move. The system can be paired with COMAND Online, live traffic information, the Mercedes-Benz Emergency Call System and with many individual Mercedes-Benz apps. While your car remembers your preferences and adapts accordingly, it can even advise you to take specific actions and interact with your social networks. Mercedes-Benz Connect turns our vision of seamlessly connected mobility into reality. In the future, the way we drive will change dramatically, making it more comfortable, more efficient and safer as a result.

A Mercedes-Benz can monitor the road situation, alert you to possible dangers, and if necessary, act independently. Our cars are becoming increasingly intelligent, too. That is why a Mercedes-Benz takes you beyond a specific destination – it takes you straight to the future.





BlueEFFICIENCY – fast forward to tomorrow

Mercedes-Benz is quicker at getting future technologies to where they matter most: on the road. With ever more efficient vehicles and a production process that wastes fewer and fewer resources. We call this comprehensive approach BlueEFFICIENCY. By way of example, BlueTEC technology for the diesel engine reduces nitrogen oxide

emissions by up to 90%. Our Hybrid models featuring an intelligent combination of internal combustion engine and electric drive can reduce fuel consumption significantly, while the SLS AMG Coupé Electric Drive takes electric mobility to a new level. Technical and aerodynamic optimisation measures right down to the last detail make

the BlueEFFICIENCY Editions available in selected model series true champions of efficiency. But every CLA-Class model already boasts a raft of BlueEFFICIENCY features – holistic vehicle optimisation measures that are adapted specifically for this model series.



- 1 Energy-saving ancillaries (petrol, water and oil pump, air-conditioning compressor and electric Sports Direct Steering managed in line with demand)
- 2 Highly efficient alternator
- 3 Direct injection petrol engine and diesel engine with optimised combustion. EU6 emissions standard for petrol and diesel engine
- 4 Outstanding aerodynamics with a drag coefficient of 0.23 (CLA 180)
- 5 ECO start/stop function
- 6 ECO display driver information for fuel-efficient driving
- 7 Dual-clutch 7G-DCT 7-speed automatic transmission (standard on CLA 220 CDI AMG Sport and CLA 250 4MATIC AMG Sport)
- 8 Tyres with lower rolling resistance, aerodynamic wheels
- 9 Intelligent weight reduction thanks to use of aluminium (front wings, bonnet and many more vital parts)



Diesel engines

Powerful, efficient and clean: the latest Mercedes-Benz diesel technology comes to full effect in the CLA, offering maximum pulling power and poise while keeping emissions and fuel consumption to a minimum.

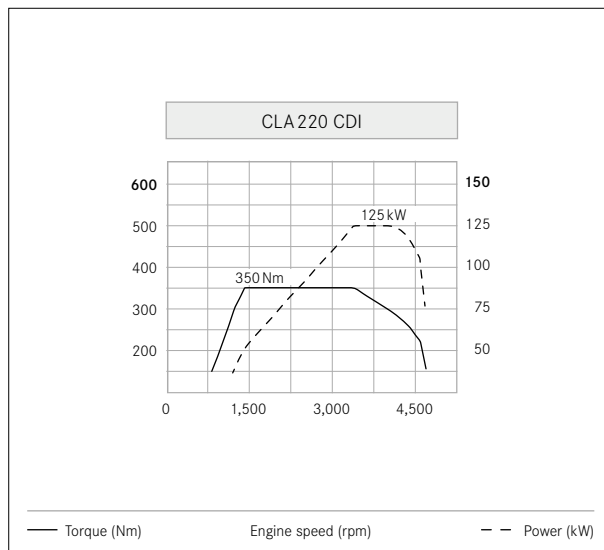

The maximum torque of 350 Nm is available from just 1,400 rpm in the CLA 220 CDI

4-cylinder engines. The CLA CDI engines offer all the familiar qualities of modern diesels, delivering generous torque, excellent low-speed responses, low CO₂ emissions and fuel consumption, as well as less vibration and minimum engine noise. You have a choice between the 136 hp (100 kW) CLA 200 CDI delivering 300 Nm maximum torque and the 170 hp (125 kW) CLA 220 CDI diesel engine with 350 Nm maximum torque.

The fourth-generation common-rail diesel system featuring higher injection pressures (1,800 bar), optimised combustion chambers and precise magnetic valve injectors. Increased combustion pressures and turbocharging with variable turbine geometry ensure high levels of torque are available at any speed.

Further efficiency measures. The CLA diesel engines also benefit from our ECO start/stop function, which cuts the engine temporarily when the car comes to a standstill. The CLA 200 CDI and CLA 220 CDI meet the latest European emissions standards (EU5 and EU6 respectively). Additionally, the standard ECO display keeps the driver informed about efficiency and encourages an economic driving style.





Petrol engines

The petrol engines in the CLA lead the way with maximum agility and refinement resulting in excellent fuel economy and significantly low emission levels.

4-cylinder engines. Developed for the compact range, the CLA 180 1.6-litre petrol engine boasts impressive levels of power and torque thanks to direct petrol injection, variable valve timing and turbocharging. Excellent low-speed responses, exemplary refinement as well as reassuringly low fuel consumption and emissions add to the exhilarating performance. The 122 hp (90 kW) 4-cylinder petrol engine delivers 200 Nm maximum torque.

Equipped with the latest all-wheel drive technology, the CLA 250 4MATIC offers 211 hp (155 kW) with a maximum torque of 350 Nm, while the CLA 45 AMG 4MATIC is the model's top performer at 360 hp (265 kW) with a maximum torque of 450 Nm. At the same time, fuel efficiency measures and low emissions ensure the CLA meets the latest European emissions standards (EU6).

In conjunction with high-pressure injection via precise piezo injectors, the optimised combustion process makes for cleaner combustion, enhancing the engines' operating

efficiency and thereby improving fuel economy. Variable valve timing, which ensures the cylinders are charged only to the degree required, helps to further reduce fuel use, as do the engines' lower weight, reduced internal friction and on-demand ancillaries. In addition, the CLA's petrol engines come with ECO start/stop as standard, enabling them to save fuel when at a standstill too.

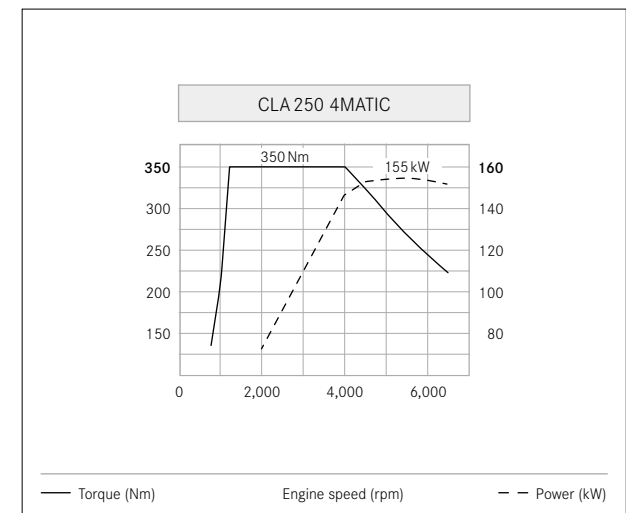

CLA 250 4MATIC maximum torque of 350 Nm is available in the range between 1,200 and 4,000 rpm





Transmission

Two ways to translate the CLA's power to the road.

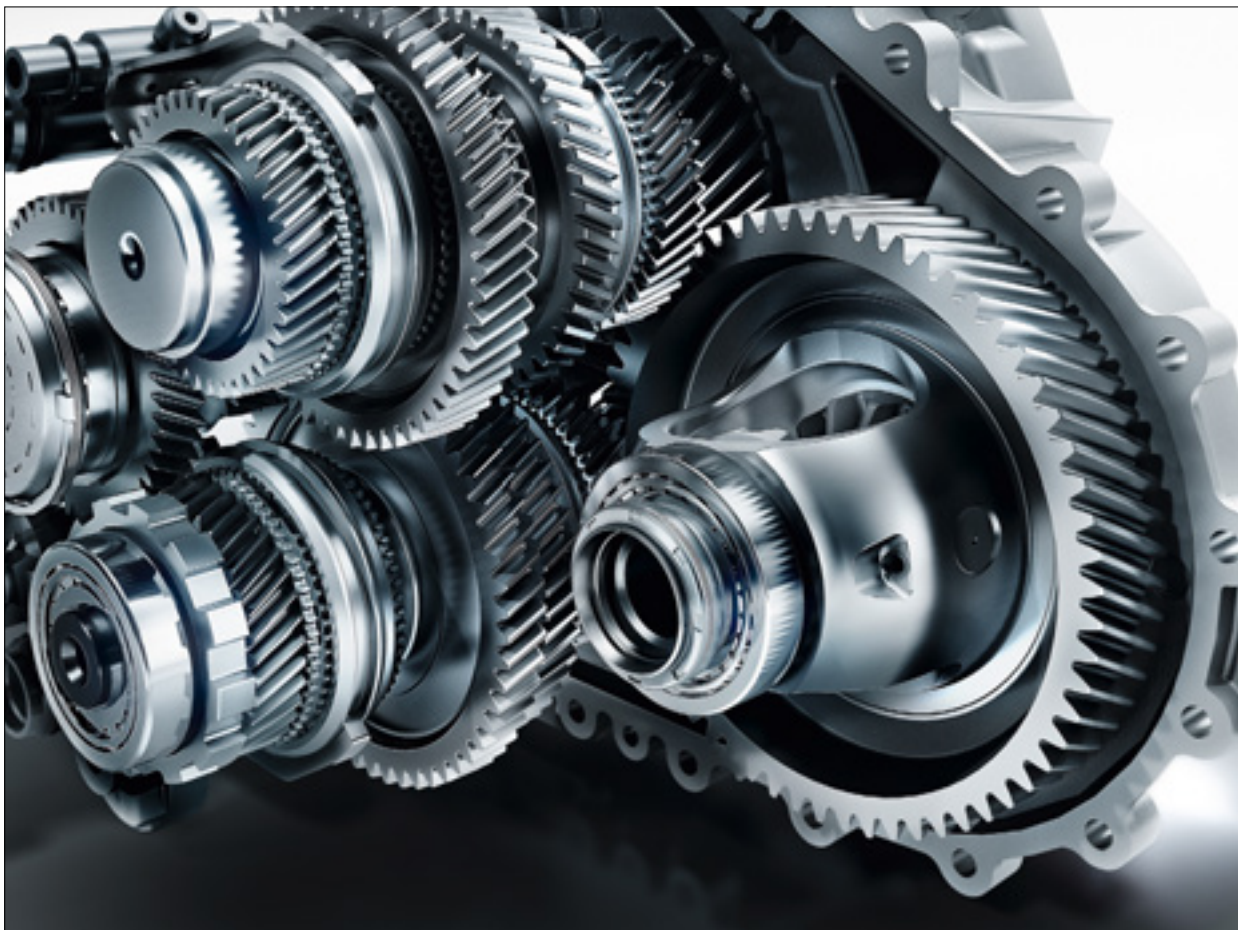

The 7G-DCT 7-speed dual-clutch transmission enables gear changes without interruption

6-speed manual transmission (standard on CLA 180 and CLA 200 CDI). This 6-speed manual transmission offers short throws and hence rapid gear changes. In addition, the new ECO indicator in the instrument panel suggests when to change gears to encourage efficient driving.

7G-DCT 7-speed automatic transmission (standard on CLA 220 CDI and CLA 250 4MATIC). This 7-speed dual-clutch transmission is an ideal blend of comfort, performance and efficiency. It consists of two independent gearbox units for the odd and even gears respectively, each with its own separate clutch. Under acceleration or deceleration, the unit is able to preselect the next ratio ready for the anticipated up- or downshift. This makes for smoother, more immediate sequential shifts with no loss of power during shifts. In 'Manual' mode, you can determine these shift points yourself via gear shift paddles on the steering wheel. 7G-DCT also features an ergonomic Direct Select gear shift lever and cruise control with Speedtronic variable speed limiter.





Suspension

Dynamics meet driving pleasure. The CLA offers a choice of comfort and sports suspension.

Comfort suspension (standard on Sport). The CLA is fitted with optimised McPherson struts at the front and an all-new multi-link rear suspension, creating the perfect balance between agility and comfort.

Sports suspension (standard on AMG Sport). It features firmer springing and damping for a sportier feel and is 15 mm lower at the front and 10 mm lower at the rear than the regular CLA suspension.

Sports Direct Steering (standard). The Sports Direct Steering system varies the steering ratio according to the steering angle, thus translating steering inputs even more immediately to the road and significantly reducing the steering effort required in tight turns or when parking. At high speeds, it offers excellent straight-line stability and provides exceptionally accurate feedback.

4MATIC. The permanent all-wheel drive system offers fully variable torque distribution between the front and the rear axle. This makes for sporty driving characteristics with optimum traction, whatever the driving conditions.

ESP® Cornering Dynamics Assist (standard). The system helps improve stability when cornering at high speeds. If the ESP® sensors detect understeer, the system intervenes by precisely applying the brakes on the front wheel closest to the corner. This results in a gentle rotation around the CLA's vertical axis, which improves steering management and overall safety due to the reduced risk of understeer.

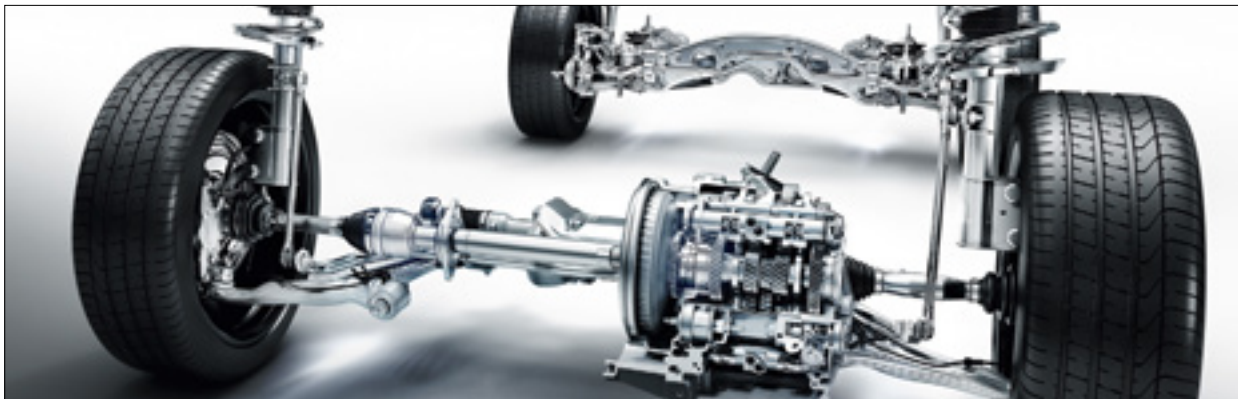

The CLA is available with comfort suspension or lowered sports suspension





Integrated safety concept

The vision of accident-free driving drives us. Our integrated safety system makes way for new technological synergies, including 'Intelligent Drive' where comfort and safety work hand in hand.

As the inventor of the motor car, we feel a particular responsibility towards road safety. That's why we were the first manufacturer to develop an integrated safety concept that seamlessly combines a car's active and passive safety features, thus ensuring optimum all-round protection. This concept covers four different areas – safer driving, anticipating danger, protecting occupants and pedestrians and post-crash safety – and incorporates measures designed to maximise safety in every situation, by helping you to stay safe, alerting you to danger, and assisting you wherever possible. In addition, our unique Pre-Safe® anticipatory safety system recognises likely accident scenarios and takes steps that help to further enhance occupant protection. If a collision can't be avoided, intelligent passive safety systems help to provide protection where it's needed, while solutions that can minimise the consequences of an accident and facilitate emergency assistance are also a key part of this safety concept.

Mercedes-Benz Intelligent Drive. A range of intelligent technologies helps detect dangerous situations and minimise potential accidents. Additionally, they assist and support the driver along the way.

Safer driving: Attention Assist (standard). Particularly beneficial on long journeys, Attention Assist is a system for detecting fatigue. Between speeds of approximately 50 and 110 mph it assesses the driver's behaviour via an array of sensors, compares it to the behaviour patterns already stored for that driver and thus registers unexpected changes that may indicate an increase in tiredness or inattentiveness.

Safer driving: Collision Prevention Assist (standard). At speeds of approximately 20 mph or above, Collision Prevention Assist recognises if you are too close to the vehicle or object in front of you, whether it's moving or stationary. It can then alert you via visual and acoustic warnings. If you apply the brakes, Adaptive Brake Assist ensures exactly the brake force required to avoid a collision.



Attention Assist recommends taking a break if the system detects signs of tiredness or inattentiveness



If Collision Prevention Assist detects that you are too close to the vehicle or object in front, it warns you





Safer driving: Adaptive Brake Assist (standard). This modular braking system combines the anti-lock braking system (ABS) and the Electronic Stability Programme (ESP®) with additional braking functions that enhance convenience and safety. By drying the brakes in the wet and priming them automatically, i.e. placing the brake pads against the discs as soon as you take your foot off the accelerator, Adaptive Brake Assist gives you even more rapid braking responses and shorter stopping distances, while the Hill Start Assist function prevents you from rolling backwards when switching from brake to accelerator on inclines. With the hold function, you can also keep the brakes engaged by twice pressing and releasing the brake pedal.

Safer driving: Lane-Keeping Assist/Blind Spot Assist (offered as Lane-Tracking Package option). Lane-Keeping Assist recognises white road markings and warns you via subtle vibrations of the steering wheel should you unintentionally stray out of lane. Blind Spot Assist, meanwhile, uses twin radar sensors to monitor the hard-to-see areas behind and to the sides and rear of the car. In lane changes at speeds of approximately 20 mph or above,

the system can detect the presence of another vehicle in your blind spot and alert you to the danger via visual and acoustic warnings.

Safer driving: Distronic Plus (optional). This radar-assisted cruise control system maintains a preset distance from the vehicle in front, accelerating and braking automatically and thus making for more relaxing progress in high-speed driving. What's more, Distronic Plus is equally effective in stop/start traffic, thanks to a sensor that reads radar signals at distances ranging from just 0.2 to 200 metres. Distronic Plus is only

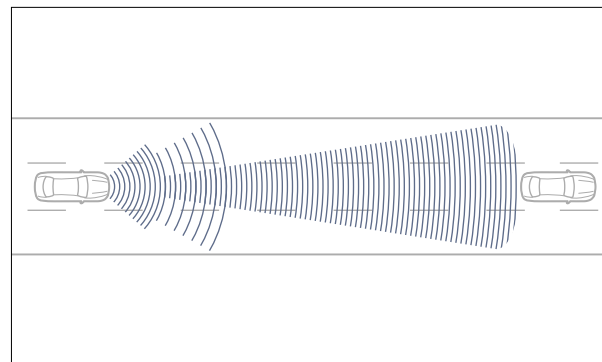

Distronic Plus radar-assisted cruise control helps the driver keep the desired distance to the car in front

available in conjunction with 7G-DCT 7-speed automatic transmission.

Safer driving: Intelligent Light System (optional). This system comprises a variety of modes and functions: country mode, motorway mode, fog mode and cornering light function. Adaptive High Beam Assist automatically maximises the headlamps' range and dips them again as soon as the lights of an oncoming vehicle are detected. Also included are LED rear tail lights and LED integral daytime running lights that help you to be seen in dull conditions.

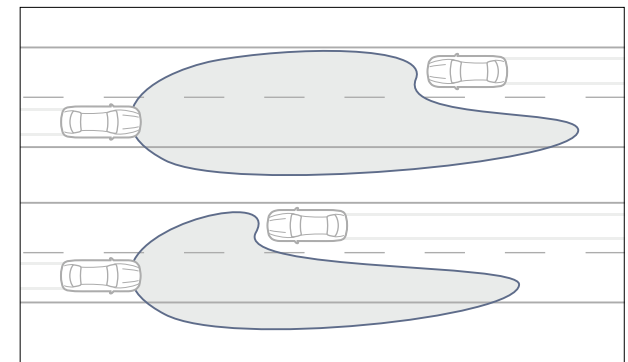

Adaptive High Beam Assist automatically lowers the headlamps' range as soon as the lights of an oncoming vehicle are detected





Anticipating danger: Pre-Safe® anticipatory safety system (optional). If it detects a probable accident scenario, Pre-Safe® can take a range of reversible anticipatory measures to prepare the occupants for an imminent impact. Pre-Safe® evaluates sensor data from systems such as ESP® and Brake Assist (BAS), enabling it to detect heavy over- or understeer and emergency braking. If need be, it can then instantly activate the front seat belt tensioners, close the windows and optional sunroof and move the front passenger seat to a safer position for an accident, ensuring maximum protection from airbags and seat belts should an impact then occur.

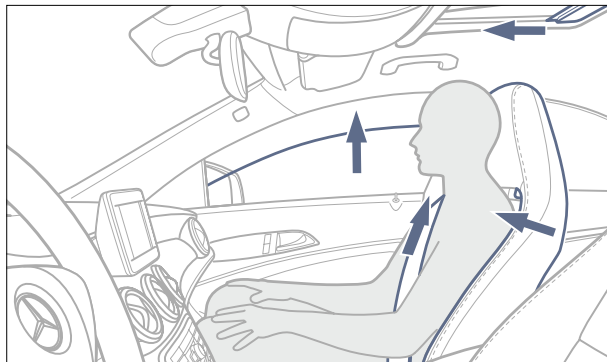

The Pre-Safe® system can detect critical situations and take anticipatory measures to enhance occupant protection

Protecting occupants and pedestrians: Active Bonnet (standard). The Active Bonnet system can reduce the risk of injury to pedestrians and cyclists in a collision. If sensors in the front bumper detect an impact, they trigger a spring mechanism that raises the bonnet slightly. The extra space this creates between the comparatively soft bonnet and the hard components beneath can help to absorb some of the impact energy and thereby reduce the risk of severe injuries. After a collision, the Active Bonnet can be returned to its normal position by the driver. Active Bonnet deploys automatically at speeds of between approx. 15 and 35 mph.

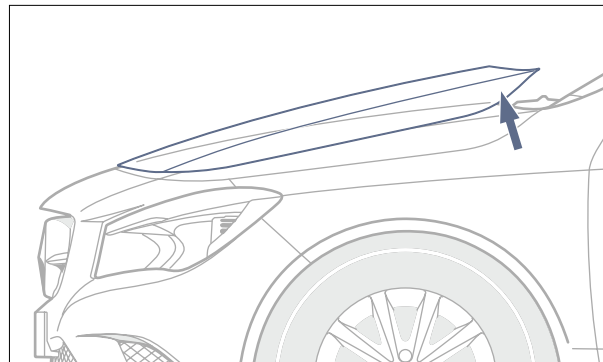

Active Bonnet helps to reduce the risk of injury to pedestrians and cyclists in the event of a collision

Protecting occupants and pedestrians: airbags (standard). In conjunction with the robust bodyshell and high-strength passenger compartment, the seven standard airbags ensure CLA occupants enjoy optimum crash protection. In addition to dual-stage front airbags, there are windowbags that stretch from the A- to the C-pillars, front seat sidebags that also offer protection for the thorax and pelvis areas and a driver's kneebag that helps to further reduce the risk of injury in the event of an impact. Optional rear sidebags are also available.

Post-crash safety: Mercedes-Benz Emergency Call System (part of the optional COMAND Online system). Should the restraint systems' sensors detect an accident, the emergency call system can use a mobile phone to automatically contact the emergency services (if the phone is switched on and connected to the vehicle). In addition, it simultaneously sends GPS data and other vehicle information to the Mercedes-Benz emergency call centre, where an operator will attempt to make contact with you by phone. The emergency call system can also be activated manually.

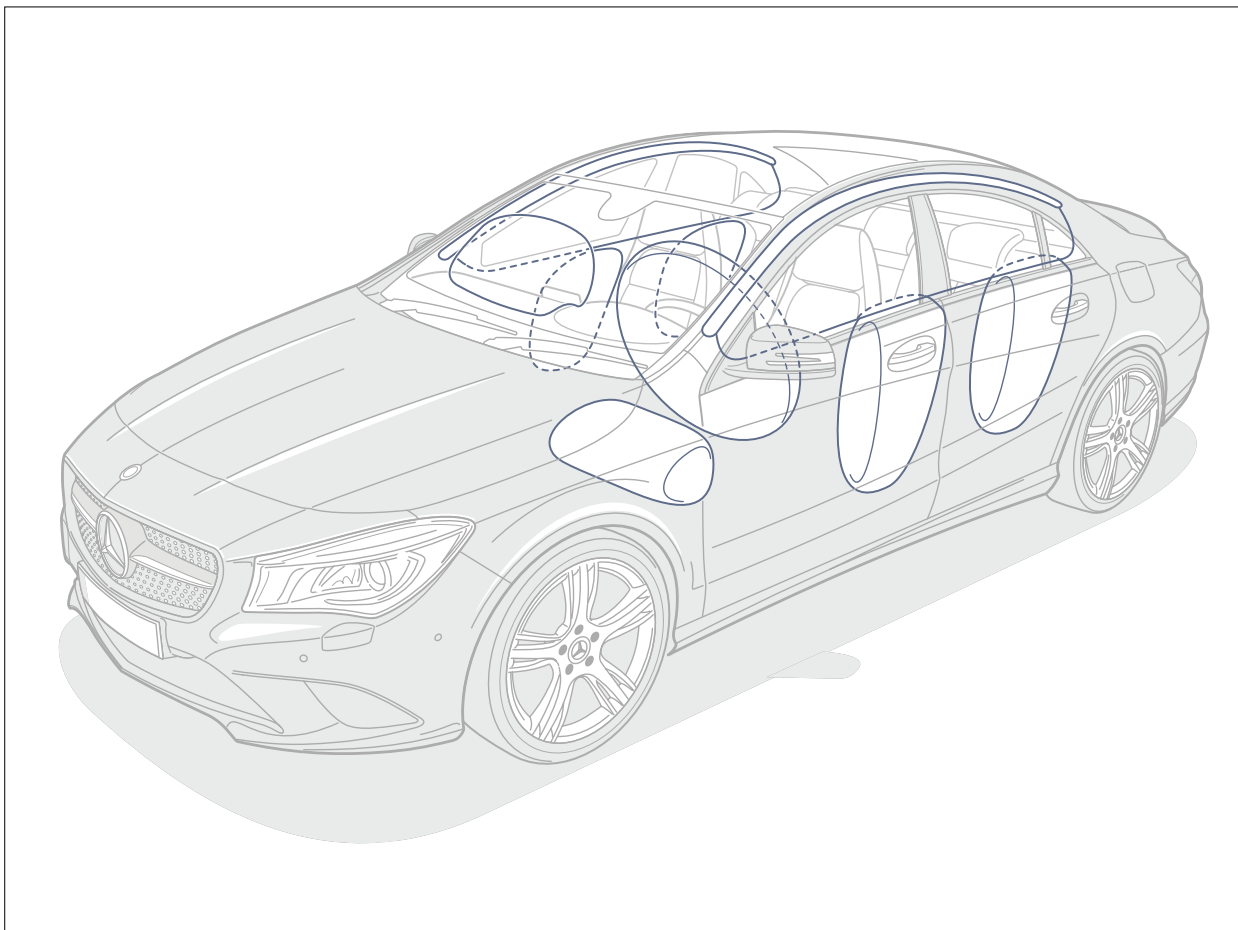

Post-crash safety: rescue assistance. Mercedes-Benz has developed a range of measures that help to minimise the secondary consequences of an accident and facilitate occupant rescue. These include automatic engine cut-off, self-activating hazard lights and emergency cabin lighting. In addition, the central locking system is automatically released in the event of an accident, and there are special crash joints between the front doors and wings that make it easier to open the doors after frontal collisions. In addition, Mercedes-Benz provides a rescue guide for emergency services that can be downloaded from the Internet at www.mercedes-benz.co.uk/rescueguide

Windowbags stretching from the A- to the C-pillars, front seat sidebags as well as a driver's kneebag feature as standard on the CLA





Multimedia systems

The CLA offers a wide range of multimedia options for your entertainment on the move.



Access the Internet, connect your iPhone® or MP3-player via the high-resolution 7-inch colour display

¹Free of charge for the first three years

COMAND Online (optional). The system combines hard disk drive (HDD) navigation with a high-resolution 7-inch tablet-design display for 3D map viewing. Multimedia functions include speed-sensitive volume control, music register with 10 GB of storage for audio files, free European map data updates¹ and live traffic information,¹ which provides precise, up-to-date traffic data for improved route planning and more accurately estimated time of arrival. A USB connection, SD memory card slot, Bluetooth® interface for hands-free access and the Media Interface allow connection to external data storage media. The DVD drive can play video and audio DVDs as well as CDs and MP3 files. The online feature allows access to the Internet and Mercedes-Benz apps via an Internet-enabled mobile phone, including Facebook, Internet radio, parking space search, special destination searches via Google Street View or sending routes from Google™ maps to the vehicle, and hotel finder as well as news and weather reports. You can operate the system via the COMAND controller and the multi-function steering wheel, or simply use Linguatronic voice control. For comprehensive information on operating the vehicle and the COMAND Online system, the Digital Owner's Manual can be called up quickly and easily.





Audio 20 radio/single CD (standard). The radio comes with six speakers that deliver crystal-clear sound and a 5.8-inch tablet-style display. In addition to a tuner and CD drive with MP3/WMA/AAC playback, the Audio 20 system features a 6-disc CD changer, Becker® Map Pilot navigation system pre-wiring, a Bluetooth® hands-free interface and USB port in the glove compartment and an integral telephone keypad.

Becker® Map Pilot navigation system (optional). Becker® Map Pilot can be integrated with the Audio 20 radio/single CD system and operated via the central controller, the multi-function steering wheel or Linguatronic voice control. It can also be tailored to your needs by downloading additional functions and map data.

Harman Kardon® Logic 7® surround sound system (optional). With its subwoofer, 9-channel DSP amplifier and Dolby Digital 5.1 and DTS technology, this high-performance 450-watt 11-speaker system delivers a truly first-class audio experience. Its surround sound can be optimised for the front, rear or middle of the cabin or for the entire interior.



The Becker® Map Pilot navigation system works with the Audio 20 radio/single CD's display and the multi-function display in the instrument cluster



The Harman Kardon® Logic 7® surround sound system ensures a first-class audio experience for every seat





Electronic assistants

A wide range of electronic assistants can enhance safety and convenience when driving and manoeuvring the CLA.

Reversing camera with parking guidelines (optional).

This wide-angle camera makes for safer and easier parking manoeuvres, capturing the area immediately behind the car and displaying the image on the central display. The camera is activated automatically as soon as the driver engages reverse.



Combined with Audio 20 or COMAND Online, the reversing camera helps you park your CLA

Speed Limit Assist (fitted with the optional COMAND Online system).

Speed Limit Assist reads speed limit signs and displays the permitted maximum speed in the instrument panel until the limit changes. The front-mounted camera detects round speed limit warnings both on roadside signs and in overhead gantries and is particularly useful in areas where the speed limit varies or when passing through roadworks. To help identify the limit correctly, it compares speed limit signs with map data from the navigation system.



COMAND Online and the multi-function display in the instrument cluster show vital Speed Limit Assist information

Active Park Assist (standard).

With Active Park Assist, the CLA can find parking spaces for you and even manoeuvre itself into them. At speeds of up to approximately 20 mph, it identifies a suitable space, then asks you to confirm whether you wish to proceed. Once you've come to a standstill and engaged reverse, the system simply steers you in (and out again if you're parking in a bay), manoeuvring so precisely that it requires a gap just 1 metre longer (or 80 cm wider for bay parking) than the car.





> View price list



> View offers



> SOUND WITH POWER



> Mercedes-Benz Magazine

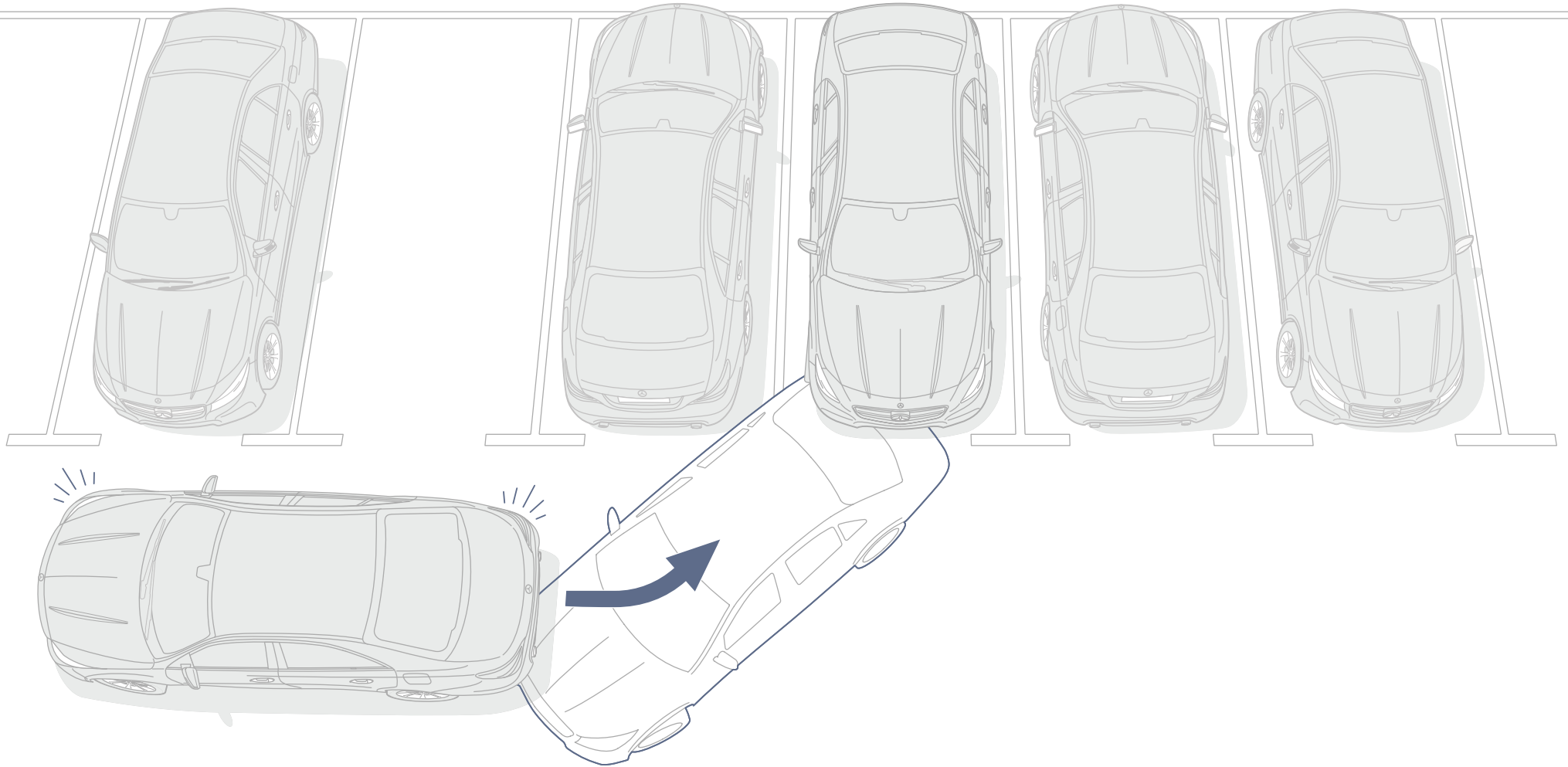

Active Park Assist helps with both parallel manoeuvring and bay parking





> View price list



> View offers



> SOUND WITH POWER



> Mercedes-Benz Magazine

Seats

The CLA features beautifully crafted standard sports seats and a whole range of additional features to give you maximum support and comfort.

Sports seats (standard). Both the CLA Sport and the CLA AMG Sport are fitted with high-quality sports seats featuring a unique design that leaves a gap between the integrated headrest and the high backrest. Additionally, both front seats come with a Seat Comfort Package including height adjusters and seat cushion angle adjustment.

Four-way lumbar adjustment for front seats (optional). This option enables the driver and front seat passenger to adjust the level of lumbar support according to their individual needs via air chambers within the front seat backrests. These twin chambers can be inflated or deflated in accordance with the occupant's chosen setting and are also height-adjustable.

Memory Package (optional). The Memory Package adds full electrical adjustment to both front seats. It also allows three sets of positions for the driver's seat, steering column and exterior mirrors to be saved and recalled at any time.



Striking design and excellent ergonomics are the hallmarks of the CLA sports seats





> View price list



> View offers



> SOUND WITH POWER



> Mercedes-Benz Magazine

Light and Sight Package

The Light and Sight Package is a reflection of the CLA's highest demands for quality and excellent design.

Light and Sight Package (standard). The Light and Sight Package enhances visibility and safety in the dark or in poor weather, adding rain-sensing wipers as well as courtesy and warning lights for the doors and tailgate. For a stylish cabin atmosphere at night, it includes illuminated door sills, ambient interior lighting for door panels, storage compartment and vanity mirrors.

There are also reading lights and a console light in the rear roof lining. Even the gap between the sport seats' headrests and backrests features ambient lighting to complete the unique CLA interior.



A range of carefully positioned ambient lights add a stylish touch to the cabin





> View price list



> View offers



> SOUND WITH POWER



> Mercedes-Benz Magazine

CLA 45 AMG 4MATIC exterior

The CLA 45 AMG 4MATIC makes a bold statement with AMG design additions that convey a look of serious power. But it knows how to pinch the pennies too. If the pack has a leader, this is it. → www.mercedes-benz.co.uk/amg



Optional 18" AMG 5-twin-spoke alloy wheels (code 649)

The CLA 45 AMG has an enviable 360 hp (265 kW) AMG engine, and looks that do justice to its power. Its AMG front splitter has high gloss black details and a twin-louvre AMG grille. It has front and rear skirts, as well as side skirts with high gloss black trim detailing which underlines its athletic credentials.

Eye-catching details abound: its AMG alloys in 5-twin-spoke design are burnished Titanium Grey. Other drivers can appreciate its chromed AMG twin exhaust as it disappears into the distance.

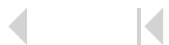



> View price list



> View offers



> SOUND WITH POWER



> Mercedes-Benz Magazine





> View price list



> View offers



> SOUND WITH POWER



> Mercedes-Benz Magazine

CLA 45 AMG 4MATIC interior

An interior that'll please you on the inside.

In a CLA 45 AMG you don't just feel the power: you can see it in every detail. AMG door sills, AMG sports seats with red stitching, light aluminium trim and the AMG Drive Unit that gives you direct access to the driving programmes – all convey a competitive edge that's pure AMG. The instrument cluster by AMG and the AMG start-up dial draw your eye; while the sports steering wheel, with its flattened lower section and gear shift paddles, begs you to take hold of it. Red seat belts and air vents with chrome accent rings give it the finishing touches.



CLA 45 AMG 4MATIC interior with a view of the rear





> View price list



> View offers



> SOUND WITH POWER



> Mercedes-Benz Magazine

AMG 40





CLA 45 AMG 4MATIC technology

There's no mistaking it: the AMG 2.0-litre turbo engine is the most powerful 4-cylinder production engine in the world. But it's more than just superb engine technology.

AMG 2.0-litre 4-cylinder turbo engine. Packed with power: with 450 Nm and 360 hp (265 kW) the 2.0-litre turbo engine is the highest-performing production line 4-cylinder engine in the world, achieving a displacement of 181 hp (133 kW). All this is made possible thanks to precision piezo injectors, a twin-scroll turbocharger, forged pistons and crankshaft, and 45 years of motorsport experience. At the same time, it achieves a frugal combined fuel consumption figure of only 39.8 mpg, thanks in part to the ECO start/stop function.

Engines by AMG are assembled by hand in accordance with the AMG philosophy of 'one man, one engine', each one carrying a plaque with the signature of the AMG technician who built it.

AMG high-performance braking system. For increased braking power the CLA 45 AMG is fitted with ventilated and perforated brake discs. The discs are large; the front ones measure 350 x 32 mm (which includes 4-piston fixed calipers) while the rear discs measure 330 x 22 mm (with single-piston sliding calipers). This allows you to bring the car to a stop even more quickly. All of which is very comforting when the car's substantial power needs to be reigned in.

AMG Speedshift DCT 7-speed sports transmission. Like the innovative engine it accompanies, this sports transmission with its quick and effortless shifting boasts shift speeds comparable to that of the SLS AMG GT. Its Controlled Efficiency, Sport and Manual modes give you a choice of three different shift styles. There's a Race Start function, a partial cylinder-disabling function when shifting up and double de-clutching when shifting down. All of this delivers an authentic motorsport feel that produces a satisfyingly rich and powerful sound.

AMG Performance 4MATIC all-wheel drive. The 450 Nm of torque makes the road a much more exciting place to be. Assisted by a variable, performance-focused all-wheel drive and an AMG-specific electro-hydraulic traction control, the car achieves optimum traction effortlessly. This in turn is responsible for taming its power and turning it into what you need: propulsion.

AMG sports parameter steering and AMG sports suspension. The electro-mechanical AMG sports parameter steering, in combination with AMG sports suspension, marries precision steering with agile handling.





> View price list



> View offers



> SOUND WITH POWER



> Mercedes-Benz Magazine

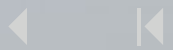



> View price list



> View offers



> SOUND WITH POWER



> Mercedes-Benz Magazine

AMG Performance Studio

Now you can make the incredible more individual, with AMG Performance Studio. Make a bold statement, or settle for a more subtle approach. It really is up to you, and how you want to drive your CLA 45 AMG 4MATIC.



With the AMG Performance Studio you can give your CLA 45 AMG its own personality. Add Performance suspension for a tighter setting, or give it a more dynamic look with the AMG Exterior Carbon Fibre Trim Package. Have the brake calipers painted red for a dose of extra drama, and choose between two additional alloy wheel designs. If you're feeling adventurous, up the top speed to 168 mph with the AMG Driver's Package. For the interior we can offer various upgrades: for instance, an AMG Performance steering wheel including E-Select gear shift lever and a master key with the AMG emblem. The AMG Performance Studio can help with almost anything you might desire.

Image features AMG Exclusive Package, AMG carbon fibre trim and AMG Performance steering wheel





> View price list



> View offers



> SOUND WITH POWER



> Mercedes-Benz Magazine





> View price list



> View offers



> SOUND WITH POWER



> Mercedes-Benz Magazine

CLA Sport

The Sport model dials up the CLA's sportiness. It features chrome trim parts and a diamond grille with black pins, a single louvre in silver and chrome trim, polished stainless steel twin-pipe exhaust system with rectangular tailpipes and 18" 5-twin-spoke alloy wheels in Himalaya Grey finish. Comfort suspension adds to the engaging CLA drive, while the standard Light and Sight Package with rain-sensing wipers offers further comfort and safety.





> View price list



> View offers



> SOUND WITH POWER



> Mercedes-Benz Magazine





> View price list



> View offers



> SOUND WITH POWER



> Mercedes-Benz Magazine



The interior makes a truly spectacular impression with sports seats fitted with Black Artico leather¹/Corumba cloth and either grey or orange chequered-design cloth upholstery. If you prefer, choose the upholstery in Grey Artico leather¹/Corumba cloth and black chequered-design cloth as a no-cost option. Trim features a wave-look pattern in either Silver or Anthracite. A multi-function steering wheel in nappa leather combines high tech with premium comfort. Sun visors with illuminated vanity mirrors also come as standard. For all your multimedia needs, there is the Audio 20 radio/single CD player with a 5.8-inch tablet-style central display and pre-wiring for the Becker[®] Map Pilot navigation system.

Upholstery

- 361 Black Artico leather¹/Corumba cloth with grey chequered design
 - 363 Black Artico leather¹/Corumba cloth with orange chequered design
 - 368 Grey Artico leather¹/Corumba cloth with black chequered design
-

Trim

- H50 Silver wave-look
 - H51 Anthracite wave-look
-

¹Man-made leather





> View price list



> View offers



> SOUND WITH POWER



> Mercedes-Benz Magazine

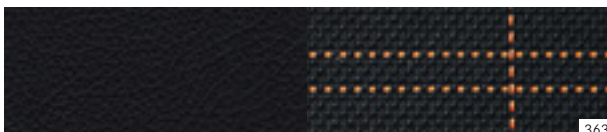
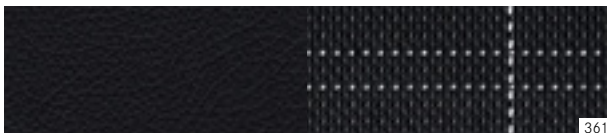



CLA AMG Sport

For an even sportier look and enhanced driving dynamic choose the AMG Sport. The striking front features a diamond grille with silver pins, a single louvre in high gloss black and silver chrome inlay. A polished chrome twin-pipe exhaust system with rectangular tailpipes adorns the rear, while AMG bodystyling – consisting of front apron, rear apron and side skirts – completes the sporty look all

round, whilst privacy glass and black beltline strips offer extra sophistication. 18" AMG alloy wheels in 5-twin-spoke design featuring front brake calipers with 'Mercedes-Benz' lettering equally add to the athletic appeal. The sports suspension with Sports Direct Steering further boosts handling performance.





> View price list



> View offers



> SOUND WITH POWER



> Mercedes-Benz Magazine





> View price list



> View offers



> SOUND WITH POWER



> Mercedes-Benz Magazine



Inside, you'll find sport seats with Black Artico leather¹/Dinamica microfibre sports seats with red contrast stitching. The flat-bottomed three-spoke multi-function sports steering wheel has nappa leather trim, red contrast stitching and embossed thumb rests. Light aluminium trim with longitudinal grain and sports pedals with rubber studs complete the AMG Sport interior.

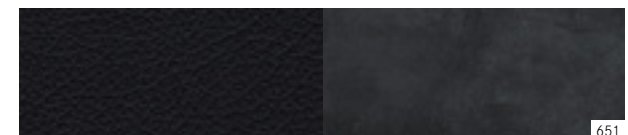

651



H79

Upholstery

651 Black Artico leather¹/Dinamica microfibre with red contrast stitching

Trim

H79 Light aluminium with longitudinal grain

¹Man-made leather





> View price list



> View offers



> SOUND WITH POWER



> Mercedes-Benz Magazine

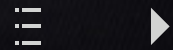
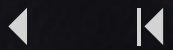



Exclusive Package



The optional Exclusive Package turns the CLA Sport interior into a true comfort zone with a large helping of sophisticated style. You're welcomed by heated sports seats with four-way lumbar support for driver and front passenger, and a choice of Lava Black, Hazelnut Brown or Crystal Grey leather upholstery. Dashboard and door trim feature trapezoid-cut aluminium. Leather trim is featured on the gear lever, complemented by interior door panels, upper dash trim and floor mats in Artico leather¹ with contrast stitching. There is also enhanced functionality, providing convenient opening and closing for the side windows using the car key.

Upholstery

- 801 Lava Black leather
- 804 Hazelnut Brown leather
- 808 Crystal Grey leather

Trim

- 739 Trapezoid-cut aluminium

¹Man-made leather

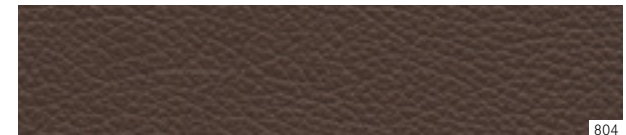
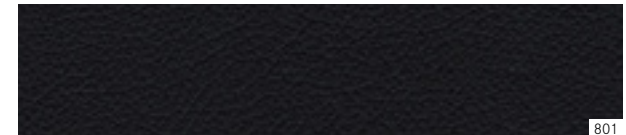



> View price list



> View offers



> SOUND WITH POWER



> Mercedes-Benz Magazine





> View price list



> View offers



> SOUND WITH POWER



> Mercedes-Benz Magazine

AMG Exclusive Package

In combination with the AMG Sport, you can give your CLA an even greater individual appeal. It offers the same heated sports seats as the Exclusive Package, yet with a twist: the AMG Exclusive Package contains Lava Black leather upholstery with red perforations and decorative red contrast stitching. Light aluminium trim with a longitudinal grain is the standard trim for this package.



Upholstery

811 Lava Black with red perforations

Trim

H79 Light aluminium with longitudinal grain





> View price list



> View offers



> SOUND WITH POWER



> Mercedes-Benz Magazine





> View price list



> View offers



> SOUND WITH POWER



> Mercedes-Benz Magazine

Standard equipment | Selection



Instrument cluster in twin-tube design with colour LCD multi-function display



Multi-function steering wheel in 3-spoke design (Sport)



Halogen headlamps with integrated daytime running lights (Sport)



LED rear tail lights



Sports seats in Artico leather¹/Corumba cloth (Sport)



Automatic climate control



Electric parking brake



Power windows (4)

¹Man-made leather





> View price list



> View offers



> SOUND WITH POWER



> Mercedes-Benz Magazine

Optional extras | Selection



Harman Kardon® Logic 7® surround sound system



Rear armrest with through-loading facility



Intelligent Light System



COMAND Online system with live traffic information



Memory Package



Reversing camera with parking guidelines



Lane-Tracking Package with Lane-Keeping Assist and Blind Spot Assist



Panoramic glass sunroof





> View price list



> View offers



> SOUND WITH POWER



> Mercedes-Benz Magazine

Alloy wheels



18" 5-twin-spoke alloy wheels in Himalaya Grey with 225/40 R 18 tyres (standard on Sport, code 66R)



18" 5-twin-spoke alloy wheels with 225/40 R 18 tyres (optional on Sport, code R31)



18" AMG 5-twin-spoke alloy wheels with 225/40 R 18 tyres (standard on AMG Sport, code 781)



18" AMG multi-spoke alloy wheels in black with 225/40 R 18 tyres (optional on AMG Sport, code 646)



19" AMG multi-spoke alloy wheels in Titanium Grey with 235/35 R 19 tyres (standard on CLA 45 AMG 4MATIC, code 780)



18" AMG 5-twin-spoke alloy wheels with 235/40 R 18 tyres (optional on CLA 45 AMG 4MATIC, code 649)



19" AMG multi-spoke alloy wheels in matt black with 235/35 R 19 tyres (optional on CLA 45 AMG 4MATIC, code 787)





Retailer-fit accessories

Practical or stylish? Our retailer-fit accessories offer plenty of options to tailor your CLA to your needs. → www.mercedes-benz.co.uk/accessories

Alloy wheels. Enhance the sporty appeal of the CLA with Mercedes-Benz alloy wheels, available in a range of different sizes and designs, such as 5-triple-spoke 18" alloy wheels in Tremolite metallic with a high-sheen finish combined with 225/40 R 18 tyres.

Drive Kit Plus for iPhone®. Bring your digital lifestyle up to speed with the innovative Drive Kit Plus for iPhone®, which allows you to use the key features of your iPhone® whilst on the move, showing the content of your phone on a revolutionary graphic design on the vehicles display. Functions include navigation, social media, AUPEO! Personal Radio and point of interest search with Google.

Roof-mounted Alustyle Bicycle Rack. This easy to fit roof-mounted bicycle rack is designed to provide secure transport for your bicycle. Each bicycle rack can hold one bicycle and depending on maximum roof load and usable width of the basic carrier bars, up to four bicycle racks can be fitted per pair of basic carrier bars. The support frame folds down when not in use to reduce drag when travelling without bicycles.



18" 5-triple-spoke alloy wheels in Tremolite metallic with 225/40 R 18 tyres



Drive Kit Plus for iPhone®





> View price list



> View offers



> SOUND WITH POWER



> Mercedes-Benz Magazine





> View price list



> View offers



> SOUND WITH POWER



> Mercedes-Benz Magazine

Services

Test drive. You've seen the pictures, you've read the facts. Now all that's missing is to experience your dream Mercedes in the flesh. Which is why we invite you to take it for a spin. See it with your own eyes. Rev up the engine, and feel how your chosen Mercedes hugs the road. Relax in style or play with a whole host of exciting onboard technology. Contact your Mercedes-Benz Retailer for a test drive, or simply go online and visit www.mercedes-benz.co.uk/testdrive. We can't wait to see you in the driving seat.

Mercedes-Benz Finance. At Mercedes-Benz Finance, our single-minded aim is to provide optimum financial solutions for all those who share the Mercedes-Benz philosophy of absolute commitment to quality. Whether you are a private customer or a business user, our finance and leasing packages can be tailored to meet your individual needs. For further information on Mercedes-Benz Finance, please contact your local Mercedes-Benz Retailer.



Mercedes-Benz Insurance offers a fully comprehensive 5-star-rated¹ Motor Insurance policy specifically designed to provide the cover you would expect from Mercedes-Benz. For a quotation, please call 0845 600 2180²

Interactive Owner's Manual. The website also offers an interactive tour, enabling you to take a closer look at your desired model. This simulation is the ideal way to acquaint yourself with your dream car. You can view key functions in detail, gain an insight into the car's inner workings or look at the benefits of each model. For further details, visit www.mercedes-benz.co.uk/claclassmanual





Roadside Assistance and Accident Management. Rest assured that should you ever need help, Mercedes-Benz Roadside Assistance is there for you. In the unlikely event of a technical breakdown³ you can rely on the Mercedes-Benz Roadside Assistance Team – anywhere in Europe. Mercedes-Benz will also assist you in the unfortunate event of an accident, from recovering your car and delivering it to your preferred Mercedes-Benz Retailer right through to managing your insurance claim in full, you will be looked after by the experts who built your Mercedes-Benz.⁴ Minor mishaps are also covered. Whether you lose your key, run out of fuel, or your vehicle is damaged due to vandalism, Mercedes-Benz ensures that you still reach your destination. Often the problem can be rectified on the spot, but if this is not possible, we will naturally ensure that your vehicle is taken to the nearest Mercedes-Benz Retailer to get you back on the road as quickly as possible.

¹ As rated by Defaqto, a leading UK independent financial research company
² Mercedes-Benz Motor Insurance is underwritten by Aviva Insurance Limited. For joint protection, calls may be recorded and/or monitored. All calls are charged at local rate. We may decline to quote in some circumstances

Simply phone our Customer Assistance Centre on 00800 1 777 7777,⁵ where our specialists will organise assistance for you.

Service Care. To keep a tight grip on costs, Mercedes-Benz offers service plans to cover the costs of an annual service, for two, three and four years. Plans can be paid monthly with interest-free instalments or alternatively, if you pay upfront, should you sell your vehicle any remaining services will be transferred to the new owner. All routine maintenance and additional items are covered. To find out more, please contact your local Retailer or visit www.mercedes-benz.co.uk/servicecare

³ Cover is initially valid for your vehicle for four years from the date of first registration. This can be extended from the fifth year, up to a maximum of 30 years, on completion of each scheduled maintenance service, providing that this service is carried out by a Mercedes-Benz Retailer. Minor mishap cover is provided at the absolute discretion of Mercedes-Benz

Mercedes-Benz World at Brooklands. Discover Mercedes-Benz racing heritage, from its connections to the famous Brooklands circuit through to present-day Formula 1™ brought to life in the most sensational way at Mercedes-Benz World in Surrey. View, touch and sit in every car from the Mercedes-Benz range, and encounter automotive legends like the ‘Gullwing’ and many other classic icons, in the UK’s largest Mercedes-Benz showcase. Then set your pulse racing by booking one of our thrilling AMG or 4×4 Driving Experiences. Relax and refuel in Café 1886, or enjoy the delicious menu and elegant surroundings of the Gullwing Bistro. For more information, visit www.mercedes-benzworld.co.uk

⁴ Management of claims for non-fault accidents only
⁵ In non-affiliated European countries: +44 20 7975 7077





Dimensions

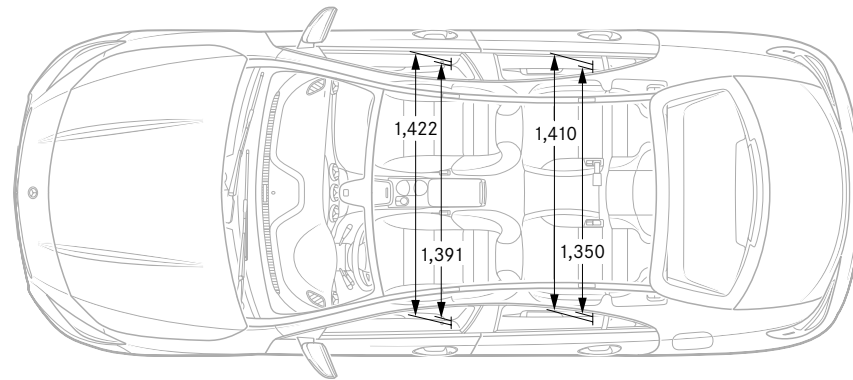
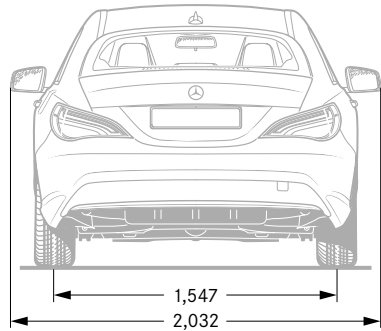
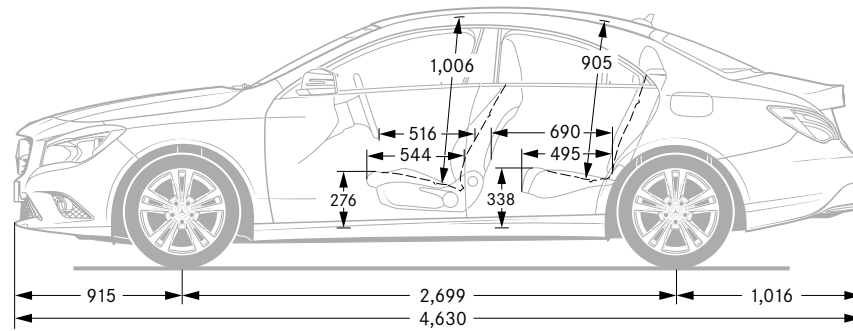
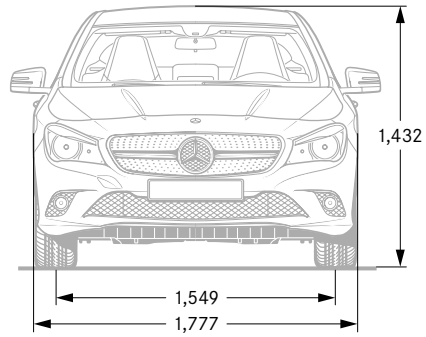

All measurements in millimetres. The dimensions shown are mean values and apply to standard-specification, unladen vehicles

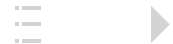



Technical data

	Diesel engines	
	CLA 200 CDI	CLA 220 CDI
Arrangement/cylinders/valves	in-line/4/16	in-line/4/16
Total displacement – cc	1,796	2,143
Rated output ¹ – hp (kW) at rpm	136 (100)/3,600–4,400	170 (125)/3,400–4,000
Rated torque ¹ – Nm at rpm	300/1,600–3,000	350/1,400–3,400
Transmission	6-speed manual [7G-DCT 7-speed automatic]	7G-DCT 7-speed automatic
Acceleration 0–62 mph – sec [auto.]	9.4 [9.3]	– [8.2]
Top speed, approx. – mph [auto.]	137 [137]	– [143]
Tyre size – front	225/40 R 18	225/40 R 18
Tyre size – rear	225/40 R 18	225/40 R 18
Fuel consumption ² – mpg [auto.]		
Urban	51.4 [54.3]	– [50.4]
Extra-urban	74.3 [67.3]	– [74.3]
Combined	64.2 [62.8]	– [62.8]
CO ₂ emissions, combined ² – g/km [auto.]	117 [118]	– [117]
Emissions class	EU5	EU6
Fuel tank capacity/of which reserve – l	50/6.0	50/6.0
Load capacity – l	470	470
Turning circle – m	11.00	11.00
Kerb weight ³ – kg [auto.]	1,480 [1,505]	– [1,525]
Perm. GVW – kg [auto.]	1,985 [1,985]	– [2,005]

¹Figures in accordance with Directive 80/1269/EEC in the currently applicable version ²The figures shown were obtained in accordance with the prescribed measuring process (Regulation [EC] 715/2007 in the currently applicable version).

The figures are not based on an individual model and do not constitute part of the product offer; they are provided solely for purposes of comparison between different vehicle models

³Figures according to Directive 92/21/EC, version 95/48/EC (kerb weight with fuel tank 90% full, driver, 68 kg, and luggage, 7 kg) for standard-specification vehicles. Optional extras and accessories will generally increase this figure and reduce the payload capacity accordingly
For further technical data, please visit www.mercedes-benz.co.uk





	Petrol engines		
	CLA 180	CLA 250 4MATIC	CLA 45 AMG 4MATIC
Arrangement/cylinders/valves	in-line/4/16	in-line/4/16	in-line/4/16
Total displacement – cc	1,595	1,991	1,991
Rated output ¹ – hp (kW) at rpm	122 (90)/5,000	211 (155)/5,000	360 (265)/6,000
Rated torque ¹ – Nm at rpm	200/1,250–4,000	350/1,200–4,000	450/2,250–5,000
Transmission	6-speed manual [7G-DCT 7-speed automatic]	7G-DCT 7-speed automatic	AMG Speedshift DCT 7-speed sports transmission
Acceleration 0–62 mph – sec [auto.]	9.3 [9.2]	– [6.6]	– [4.6]
Top speed, approx. – mph [auto.]	130 [130]	– [149]	– [155 ²]
Tyre size – front	225/40 R18	225/40 R18	235/35 R19
Tyre size – rear	225/40 R18	225/40 R18	235/35 R19
Fuel consumption ³ – mpg [auto.]			
Urban	37.7 [39.8]	– [33.6]	– [31.0]
Extra-urban	62.8 [61.4]	– [51.4]	– [47.9]
Combined	50.4 [51.4]	– [42.8]	– [39.8]
CO ₂ emissions, combined ³ – g/km [auto.]	130 [129]	– [154]	– [165]
Emissions class	EU6	EU6	EU6
Fuel tank capacity/of which reserve – l	50/6.0	56/6.0	56/8.0
Load capacity – l	470	470	470
Turning circle – m	11.00	11.00	11.04
Kerb weight ⁴ – kg [auto.]	1,395 [1,430]	– [1,540]	– [1,585]
Perm. GVW – kg [auto.]	1,920 [1,920]	– [2,025]	– [2,075]

¹Figures in accordance with Directive 80/1269/EEC in the currently applicable version ²Electronically limited ³The figures shown were obtained in accordance with the prescribed measuring process (Regulation [EC] 715/2007 in the currently applicable version).

The figures are not based on an individual model and do not constitute part of the product offer; they are provided solely for purposes of comparison between different vehicle models

⁴Figures according to Directive 92/21/EC, version 95/48/EC (kerb weight with fuel tank 90% full, driver, 68 kg, and luggage, 7 kg) for standard-specification vehicles. Optional extras and accessories will generally increase this figure and reduce the payload capacity accordingly
For further technical data, please visit www.mercedes-benz.co.uk

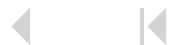



Paint finishes

The highly durable nature of the Mercedes-Benz paint system makes it one of the best clear coats available in the automotive industry. A highly dense molecular structure provides the key to the extremely resilient paint, regardless whether it's non-metallic or metallic, giving the surface a longer lasting, more intense shine.

Non-metallic paints (standard)

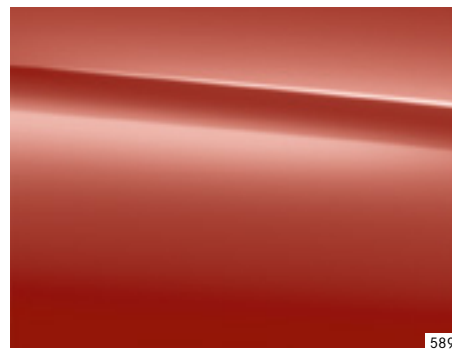

589



650

Metallic paints (optional)

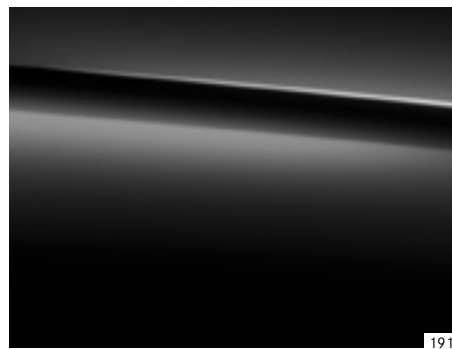

191

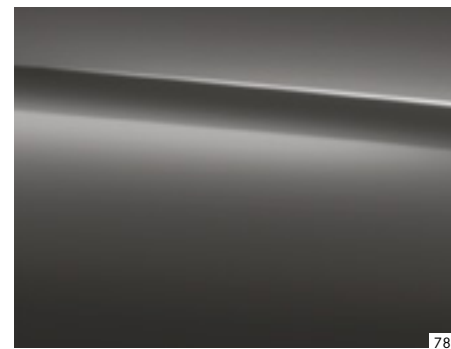

787

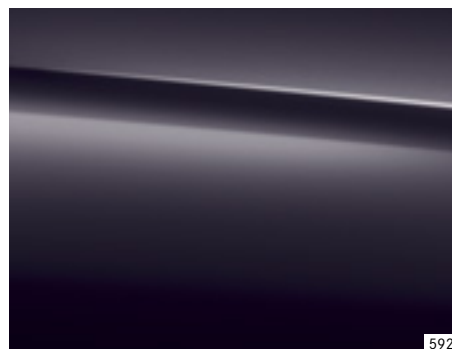

592

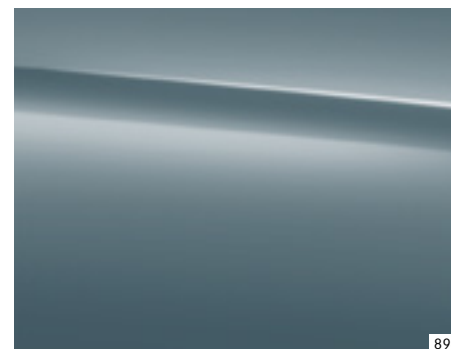

894

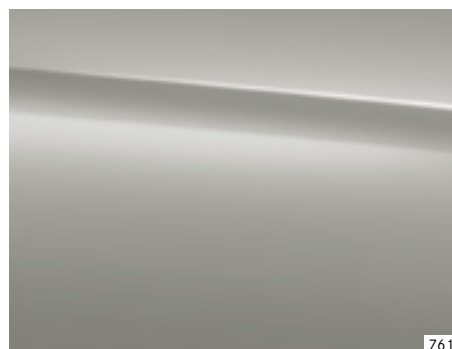

761

Non-metallic paints (standard)

- 589 Jupiter Red
- 650 Cirrus White

Metallic paints (optional)

- 191 Cosmos Black
- 592 Northern Lights Violet
- 761 Polar Silver
- 787 Mountain Grey
- 894 Universe Blue





> View price list



> View offers



> SOUND WITH POWER



> Mercedes-Benz Magazine

Take-back of end-of-life vehicles. Coming full circle. At the end of its long life, you can return your CLA-Class to us for environment-friendly disposal in accordance with the EC End-of-Life Vehicle Directive.¹ But that day lies a long way off.

¹Applies in accordance with national regulations to vehicles up to 3.5 t permissible gross weight. The CLA-Class has met the statutory regulations governing the suitability of the vehicle's design for reuse and recycling for a number of years now. A network of vehicle take-back depots and dismantlers has been established which will process your vehicle in an environment-friendly manner. The ways in which both vehicles and parts can be recovered are subject to ongoing development and improvement. Consequently, the CLA-Class will be able to comply with any future increases in the recycling quota within the stipulated time limits. Further information is available at www.mercedes-benz.co.uk or by calling 0808 156 6606.

Please note: changes may have been made to the products since this brochure went to press (22.07.2013). The manufacturer reserves the right to make changes to the design, form, colour and specification during the delivery period, provided these changes, while taking into account the interests of the vendor, can be deemed reasonable with respect to the purchaser. Where the vendor or the manufacturer uses symbols or numbers to describe an order or the subject of an order, no rights may be derived solely from these. The illustrations may show accessories and items of optional equipment which are not part of standard specification. Colours may differ slightly from those shown in the brochure, owing to the limitations of the printing process. This brochure has been compiled by Daimler AG of Germany and is distributed internationally. It provides a general indication of the range of models, features, optional extras and/or colours available in various countries. Some of the models, features, optional extras and/or colours shown may not be available in your country or may only be available in a different specification. Additionally some models, features, optional extras and/or colours may only be available in combination with others. For current and more specific information in relation to the range of models, features, optional extras and/or colours available in your country, and their pricing, you should contact your nearest authorised Mercedes-Benz Retailer. E&OE. www.mercedes-benz.co.uk

Daimler AG, Mercedesstr. 137, 70327 Stuttgart BC/MC 6701 · 1702 · 88-02/1213 Printed in Germany

