



> View price list



> View offers



> New C-Class



> Mercedes-Benz Magazine

SLK-Class



Mercedes-Benz





> View price list



> View offers



> New C-Class



> Mercedes-Benz Magazine

You've never felt closer to the road.

The long bonnet, short overhangs and set-back cabin promise unbridled excitement; the drive never fails to deliver. Powerful yet efficient engines, pin-sharp handling, precision transmissions: the SLK offers sporting thrills in abundance – yet remains refined and relaxing at all times. Highly supportive sports seats, outstanding ergonomics and luxurious appointments mean this is a roadster that makes even the longest journey a pleasure.

What's more, the SLK is available with innovative features that further enhance your comfort and enjoyment – such as the optional Airguide wind deflector and the panoramic vario-roof with Magic Sky Control, which switches from transparent to tinted at the touch of a button. As you'd expect from a Mercedes-Benz, the SLK leads the way when it comes to safety too, combining advanced roadster-specific protection systems with a range of intelligent electronic assistants.





> View price list



> View offers



> New C-Class



> Mercedes-Benz Magazine

Featured models at a glance:

4 | Mercedes-Benz SLK 250 CDI

Palladium Silver metallic

Optional 18" Alloy wheels in 5-spoke design, optional nappa leather in Bengal Red, brushed aluminium trim

5 | Mercedes-Benz SLK 250 AMG Sport

designo Hyacinth Red metallic¹

Standard 18" AMG alloy wheels in 5-spoke design, optional Black leather, brushed aluminium trim

Vision

16 | Innovation that moves

Engine and suspension

17 | Petrol engines

19 | Diesel engine

20 | Transmissions

21 | Suspension

Safety

23 | Integrated safety concept

Comfort

27 | Multimedia systems

28 | Electronic assistants

29 | Open-top comfort

30 | Roof systems

31 | Climate control and interior lighting

32 | Seats

AMG

33 | SLK 55 AMG exterior

35 | SLK 55 AMG interior

37 | SLK 55 AMG technology

38 | AMG Performance Studio

Equipment

39 | Upholstery and trim

45 | SLK AMG Sport exterior

47 | SLK AMG Sport interior

49 | *designo*

51 | Standard equipment

53 | Optional extras

55 | Alloy wheels

57 | Retailer-fit accessories

59 | Services

Facts and finishes

61 | Dimensions

62 | Technical data

64 | Paint finishes

¹Please check with your Retailer for availability
Images may show accessories or items of optional equipment which are not part of standard specification

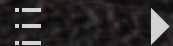



> View price list



> View offers



> New C-Class



> Mercedes-Benz Magazine

Precision driver meets precision driving machine.





> View price list



> View offers



> New C-Class



> Mercedes-Benz Magazine

The roadster perfected.



One glance is enough to send your pulse from rest to racing. It's simply a joy to behold – and to drive. Grasp the sports steering wheel, flex your right foot, and feel closer to the road than you've ever felt before.

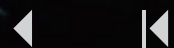



> View price list



> View offers



> New C-Class



> Mercedes-Benz Magazine



Rubber grips salt, shattering countless tiny crystals. The scenery begins to blur. The performance is captivating – and nothing can break the spell.





> View price list



> View offers



> New C-Class



> Mercedes-Benz Magazine

A comet among stars.

Day becomes night, another breathtaking journey comes to an end. Reluctantly, you climb out of your low-slung seat and take a long look at those glorious lines. They seem somehow more muscular, more perfect than ever. Perhaps it's your imagination. Or the endorphins that are still coursing through your veins.





> View price list



> View offers



> New C-Class



> Mercedes-Benz Magazine



Sharp bends, open straights, high-speed manoeuvres: the SLK ensures you enjoy every exhilarating moment, while helping you stay safe at the same time. Its intelligent assistants can monitor changes in the speed limit, help you to keep a safe distance, and even spot signs of tiredness – often recognising the need for a coffee break long before you do.





> View price list



> View offers



> New C-Class



> Mercedes-Benz Magazine

The face is unmistakable.
The performance unforgettable.





> View price list



> View offers



> New C-Class



> Mercedes-Benz Magazine

Enter here for endless driving pleasure.

Make yourself comfortable – in a roadster where intimacy meets Mercedes-Benz luxury. The supportive sports seats fit like a glove; the 3-spoke steering wheel falls perfectly to hand. Around you are intuitive and intelligently placed controls. Has ergonomics ever felt more exhilarating?





> View price list



> View offers



> New C-Class



> Mercedes-Benz Magazine

Not even the petrol pump can spoil your enjoyment.

Whatever the weather, the SLK rarely gets thirsty. Lightweight materials, excellent aerodynamics and efficient engines help to significantly reduce its fuel consumption, giving you even more pleasure per gallon – and a cleaner conscience to boot.





> View price list



> View offers



> New C-Class



> Mercedes-Benz Magazine

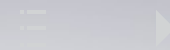



> View price list



> View offers



> New C-Class



> Mercedes-Benz Magazine

Roadster driving at its most refined.



Enjoy the wind in your hair – without getting a draught in your neck. The SLK's aerodynamic design and optional Airguide help to minimise turbulence, giving the occupants a smoother, quieter ride, while the optional Airscarf keeps heads and necks warm even in cooler open-top driving.





> View price list



> View offers



> New C-Class



> Mercedes-Benz Magazine

The roof that changes to suit the sky.

Open or shut, sunlit or shady: the SLK lets you choose according to the conditions. Its optional panoramic vario-roof not only folds away in a matter of seconds – it gives you clear sky views even when closed. Choose the panoramic vario-roof with Magic Sky Control and you can alter its transparency at the touch of a button.





> View price list



> View offers



> New C-Class



> Mercedes-Benz Magazine



A safer form of adrenaline rush.

The SLK is built to look after you come what may. With a stiffened bodyshell, large head airbags and Neck-Pro active head restraints, it guarantees not just maximum exhilaration but optimum occupant protection too.





> View price list



> View offers



> New C-Class



> Mercedes-Benz Magazine

What makes a car a Mercedes?

Tradition comes with responsibility. To us, it means commitment to innovation. We have always explored uncharted territory, setting milestones all along the way: the first vehicle with a crumple zone, the first ABS, the first diesel car or, indeed, the first car. But why dwell on the past, when there's so much to look forward to?

Mercedes me – welcome to a world that revolves around you. For us, the focus is on people. To pursue this responsibility we have developed a new platform to enable your own personal contact with Mercedes-Benz, with individual services that are made for you. *Connect me* connects the vehicle with your adventure world, with everything that is important to you. *Move me* offers new mobility solutions. And with *Inspire me*, we provide an exclusive glimpse into the future of mobility. Your access to a fascinating world: www.mercedes.me



Mercedes-Benz Intelligent Drive – our vision of accident-free driving. At its heart are intelligent technologies actively supporting the driver and increasing the driver's comfort. Crucial electronic assistants are already at work in your Mercedes-Benz, automatically helping to keep the car at a safe distance from the vehicle in front, braking when necessary and warning the driver of impending rear-end collisions or of vehicles in the blind spot. By intelligently combining sensors of safety systems and electronic assistants, potentially dangerous situations are identified much earlier and are consequently ever more frequently avoided. To discover the pioneering world of Mercedes-Benz Intelligent Drive visit www.mercedes-benz-intelligent-drive.com

BlueEFFICIENCY – our vision of zero-emission driving. While 'sustainability' is a big word, we lend it real meaning in everything we do. From the most eco-friendly manufacturing process possible through to alternative drive concepts.

As you can see, we've set ourselves far-reaching goals. But what could be more pleasant than to enjoy the journey in a Mercedes-Benz?

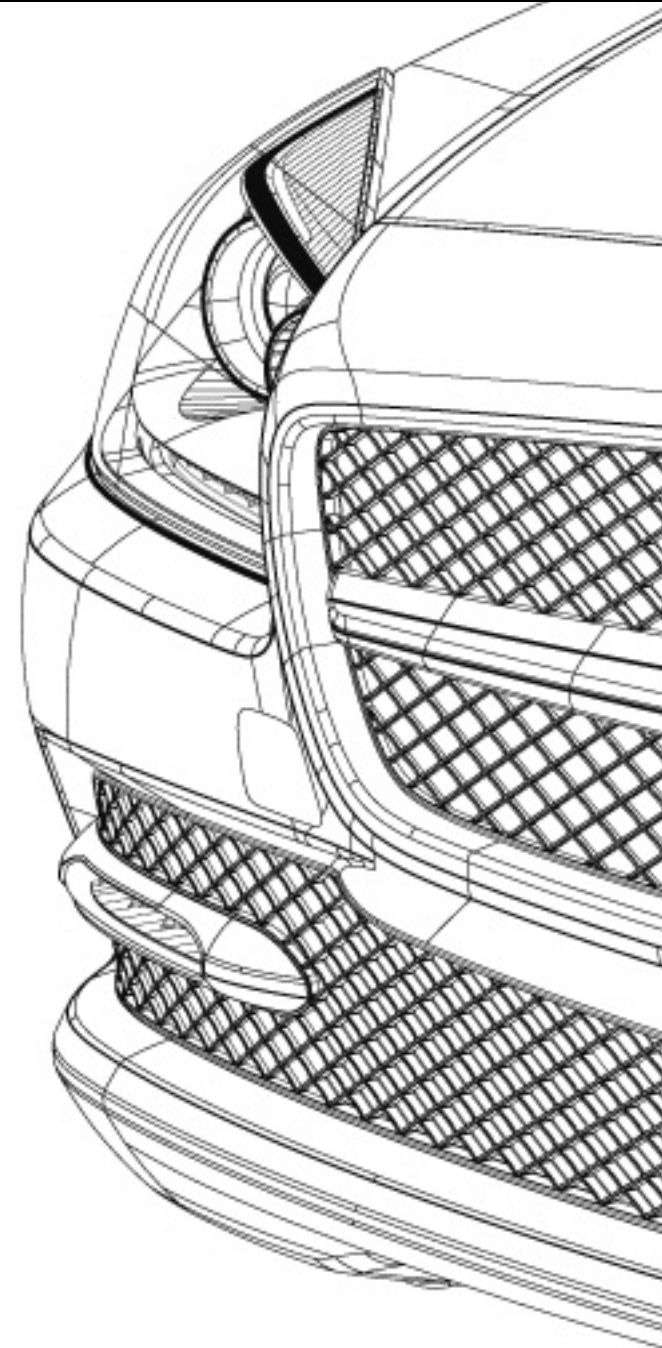



Petrol engines

Our latest-generation petrol engines prove driving pleasure and efficiency can go hand in hand. Thanks to innovative technology, they combine powerful performance with low fuel consumption and emissions. In fact, the SLK is up to 25% more efficient than its predecessor.

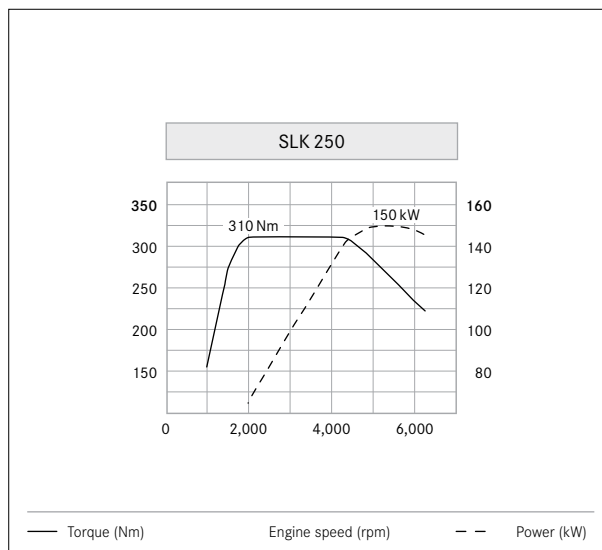

With an output of 204 hp (150 kW), the SLK 250 delivers sporty performance

4-cylinder petrol engines. Direct petrol injection, turbo-charging and twin overhead camshafts help the SLK's optimised 4-cylinder petrol engines to deliver high levels of power and torque along with low fuel consumption and emissions.

More complete combustion and variable valve control ensure these innovative engines use fuel more efficiently, while weight savings and lower internal friction help to further reduce their fuel consumption. In addition, 4-cylinder SLK models meet the stricter EU5 emissions standards.

The SLK offers a choice of two 4-cylinder petrol models: the SLK 200 delivers 184 hp (135 kW) and 250 Nm of torque; the SLK 250 has 204 hp (150 kW) and 310 Nm of torque. Both feature twin balancer shafts for optimum refinement yet deliver a satisfying sound that underlines the car's sporting intentions.

All models come with ECO start/stop function as standard. It cuts the engine automatically at traffic lights and when queuing, further helping to reduce fuel consumption.





V6 petrol engine. The V6 for the SLK 350 improves performance yet cuts fuel consumption and CO₂ emissions similarly by more than 20% when compared to the previous model. High-pressure direct petrol injection with spray-guided combustion and ultra-precise piezo injectors help it deliver an output of 306 hp (225 kW) and a maximum 370 Nm of torque, while the standard ECO start/stop function, intake and exhaust system, on-demand ancillaries, intelligent alternator management and lightweight construction all further enhance its fuel efficiency. The engine responds instantly even at low revs and delivers a typically satisfying 6-cylinder sound, while remaining highly refined at all speeds.



The SLK engines combine driving pleasure with low fuel consumption and emissions

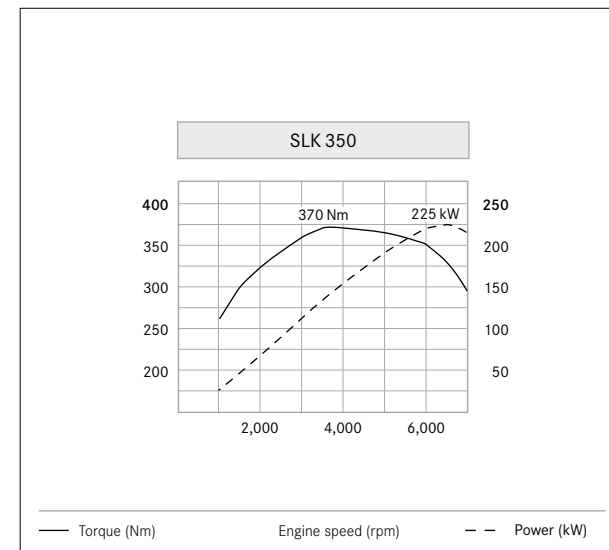

The SLK 350 features a state-of-the-art direct petrol injection V6





Diesel engine

A surprising roadster with an even more surprising diesel engine: the 4-cylinder engine delivering 204 hp (150 kW) and 500 Nm of torque.

4-cylinder diesel engine. The SLK diesel engine offers a surprisingly sporty drive thanks to its innovative 2.1-litre biturbo technology. Frugal when it comes to fuel consumption and emissions, this SLK diesel is the most efficient in its segment – yet it performs like a powerful sports car. It accelerates from 0 to 60 mph in just 6.7 seconds. In-between sprints are simply a joy as the engine reaches its top level of torque (500 Nm) from just 1,600 rpm, providing unparalleled agility on the road. Behind this is a whole range of innovative technology including our fourth-generation common-rail system. It allows fuel to be ejected at even higher levels (2,000 bar) and works in conjunction with the ultra-precise piezo injectors and optimised combustion chambers.

Optimised combustion pressure, twin turbochargers and a refined generator management maximise performance and efficiency across the rev range. Additionally, two Lanchester balance shafts ensure a smooth ride at all speeds. It all adds to a sports car experience courtesy of a striking diesel engine.

Efficiency is also no stranger to the diesel engine. As with both petrol engines, ECO start/stop function comes as standard. It cuts the engine automatically at traffic lights and when queuing, helping to further reduce fuel consumption.



The diesel engine, with 204 hp (150 kW) output, delivers a sporty performance while being efficient in terms of consumption and CO₂ emissions



Transmissions

The transmissions for the SLK are perfectly matched to its engines. They offer a choice of manual and automatic systems, enabling you to opt for a sporty or economical driving style, and are ergonomic and easy to use.

6-speed manual transmission. The SLK 200 and SLK 250 feature our 6-speed manual transmission. It offers quick and precise gear changes, with ratios carefully matched to engine performance, and helps you save fuel by indicating the most efficient shift point in the instrument panel.

7G-Tronic Plus. The latest version of our 7-speed automatic transmission is fitted as standard on the SLK 250 CDI and SLK 350 and available as an option for the SLK 200 and SLK 250. It ensures the engine is always operating at the optimum speed, delivers faster, smoother shifts and provides better acceleration, even skipping gears in kickdown for more rapid overtaking.

One of the key improvements for 7G-Tronic Plus is the addition of a new-generation torque converter that delivers even sportier throttle responses, greater durability, lower noise levels and significantly improved efficiency. 7G-Tronic Plus also allows you to select either 'Economy' or 'Sport' mode via a switch in the centre console. If the optional steering wheel shift paddles are fitted, there's also an additional 'Manual' mode for even faster gear changes.



7G-Tronic Plus: the result of more than 50 years' experience in automatic transmission technology



> View price list



> View offers



> New C-Class



> Mercedes-Benz Magazine

Suspension

The SLK is set up to give you both dynamic handling and remarkable ride comfort. The lowered sports suspension further increases agility, while the Dynamic Handling Package includes a 'Sport' mode for even greater driving enjoyment.

Sports suspension (optional). On the SLK AMG Sport, a 10-millimetre lower sports suspension is fitted as standard. It features shorter springs and firmer dampers plus larger-diameter anti-roll bars that reduce body roll and enhance stability.

Dynamic Handling Package with Adaptive Damping System (ADS) (optional). The Dynamic Handling Package features an electronically controlled damping system that continuously adjusts the damping levels at each wheel to the current situation and surface. The result is greater stability at all speeds – and a significant increase

in driving enjoyment. The package also includes a 'Sport' mode that enables you to opt for firmer settings at the touch of a button, and a separate 'E/S' switch that gives you faster shifts and more rapid acceleration on demand (automatic transmission models only).

Direct Steering (optional, standard with Dynamic Handling Package). Direct Steering combines the speed-sensitive power assistance from our parameter steering system with a variable-ratio steering rack. Speed-sensitive assistance significantly reduces the required steering input at low speeds, while the variable-ratio rack

translates inputs more immediately to the road. This increases agility and further reduces the effort required for large steering angles, while a less direct ratio in central positions ensures optimum stability in straight-line driving.

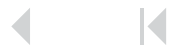



> View price list



> View offers



> New C-Class



> Mercedes-Benz Magazine

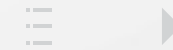



Integrated safety concept

Like all our passenger cars, the SLK-Class is built according to an integrated safety concept. It ensures the many passive and active protection systems work together to enhance safety in every situation – helping to bring our vision of accident-free driving another step closer.

As the inventor of the motor car, we feel a particular responsibility towards road safety. That's why we were the first manufacturer to develop an integrated safety concept that seamlessly combines a car's active and passive safety features, thus ensuring optimum all-round protection. This concept covers four different areas – safer driving, anticipating danger, protecting occupants and post-crash safety – and incorporates measures designed to maximise safety in every situation, by helping you to stay safe, alerting you to danger, and assisting you wherever possible. In addition, our unique Pre-Safe® anticipatory safety system recognises likely accident scenarios and takes steps that help to further enhance occupant protection. If a collision can't be avoided, intelligent passive safety systems help to provide protection where it's needed, while solutions that can minimise the consequences of an accident and facilitate emergency assistance are also a key part of this safety concept. A selection of these technologies for the phases 'safer driving', 'anticipating danger', 'protecting occupants' and 'post-crash safety' are presented on the following pages.

Safer driving: Attention Assist (standard). Particularly beneficial on long journeys, Attention Assist is an innovative system for detecting fatigue. Between speeds of approximately 50 and 110 mph, it assesses the driver's behaviour via an array of sensors and registers unexpected changes that may indicate tiredness or concentration lapses, such as involuntary movements of the steering wheel.



If it detects signs of tiredness or concentration lapses, Attention Assist suggests taking a break

Safer driving: Intelligent Light System (optional).

The Intelligent Light System comprises a variety of modes and functions that help you to recognise the line of the road, and to spot pedestrians or other potential sources of danger earlier and more reliably. Country mode directs extra light towards the side of the road, motorway mode illuminates the entire carriageway, while fog mode helps you see better in low-visibility conditions. Also included are the Active Light System, which angles the headlamp beams in bends, and a cornering light function.



The Intelligent Light System adapts automatically to different roads and conditions¹

¹Model shown in optional *designo* Hyacinth Red metallic paint (code 996). Please check with your Retailer for availability





Safer driving: Driving Assistance Package (optional).

This package comprises a range of intelligent safety technologies. Active Lane-Keeping Assist draws the driver's attention to unintended lane changes, gently vibrating the steering wheel if the car wanders across lane markings. If the driver doesn't react to the warning, the system is able to intervene in order to correct the car's course. Active Blind Spot Assist makes intentional lane changes safer too, using twin radar sensors to watch over the areas not visible in your exterior mirrors.

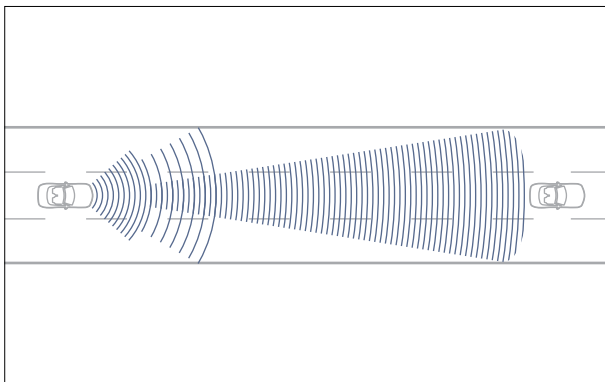

DISTRONIC PLUS can automatically maintain a minimum distance between you and the vehicle in front

If the sensors spot a vehicle in one of these blind spots, a flashing red triangle appears in the corresponding mirror, accompanied by an acoustic warning from the instrument panel. Should the driver nevertheless proceed to change lanes, the system can intervene and help prevent a collision by automatically applying the brakes on the appropriate side. DISTRONIC PLUS radar-assisted cruise control, meanwhile, enables the car to automatically maintain a preset distance from the vehicle in front, both in high-speed driving and in stop/start traffic. Also included in the package are our Brake Assist (BAS Plus) and Pre-Safe® Brake systems - to give that feeling of safety on every trip.

Anticipating danger: Pre-Safe® Brake and BAS Plus

(part of optional Driving Assistance Package). If it detects the risk of a collision, Pre-Safe® Brake alerts the driver via visual and audible warnings. At the same time, BAS Plus assesses the brake force required in order to avoid an impact. If the driver applies the brakes but uses insufficient force, BAS Plus automatically raises the braking pressure to a level that exploits the remaining stopping distance to the full, thereby also lessening the likelihood of a shunt from behind. Should the driver fail to react to Pre-Safe® Brake's warning signals, it slows the car automatically, providing a further warning, and triggers a range of Pre-Safe® measures. If the driver still doesn't respond, the system then initiates autonomous emergency braking, enabling the speed and severity of any impact to be significantly reduced.



Anticipating danger: Pre-Safe® anticipatory safety system (standard). If it detects a probable accident situation, Pre-Safe® can take anticipatory measures to protect the occupants, such as activating the seat belt tensioners, automatically closing the windows and panoramic glass sunroof (if fitted) when high lateral forces are involved, and moving the front passenger seat – if optional Memory Package fitted – to a better position for an impact.

Protecting occupants: restraint systems (standard). The 3-point seat belts, seat belt tensioners, belt force limiters and airbags are all carefully coordinated so as to keep injuries to a minimum. The SLK is fitted with six airbags as standard to ensure optimum occupant protection, with dual-stage front airbags, side and headbags for the driver and front passenger to give added protection in a side collision or rollover. If the crash sensors detect an impact, the seat belts are instantly tensed, helping to ensure the occupants remain firmly in their seats, while the belt force limiter relaxes the belt as the situation allows, in order to prevent undue force being applied to the rib cage.

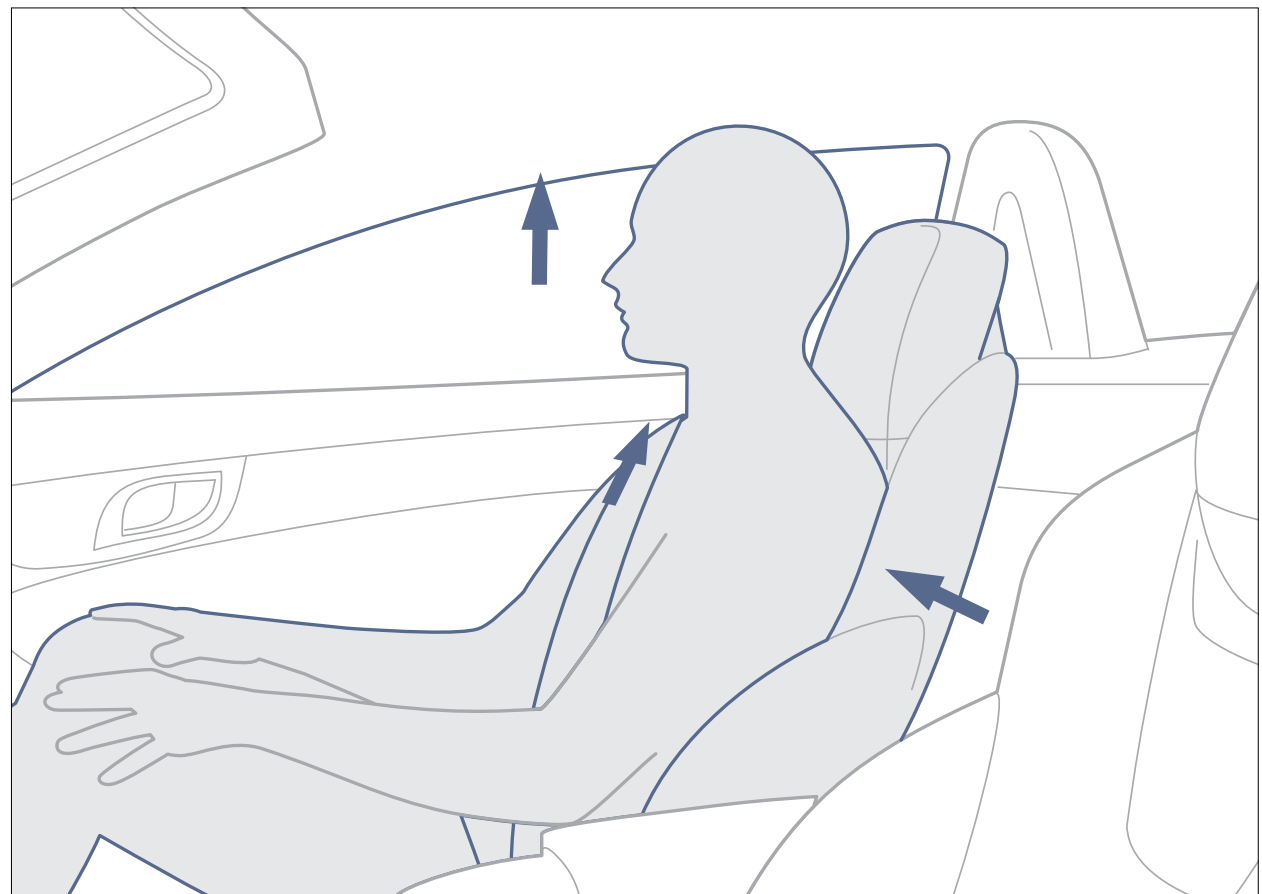

If it detects a probable accident situation, Pre-Safe® can take anticipatory measures to protect the occupants, such as activating the seat belt tensioners, automatically closing the windows and sunroof (if fitted), and moving the passenger seat to a better position for an impact



Protecting occupants: Neck-Pro active head restraints (standard). The Neck-Pro active head restraints help to improve impact protection and reduce the risk of whiplash injuries. In the event of a rear-end impact, they are raised by 30 millimetres and move approximately 40 millimetres further forward, enabling them to support the head sooner.

Protecting occupants: Active Bonnet (standard). Active Bonnet helps reduce the risk of injury to more vulnerable road users, such as pedestrians and cyclists. On impact, the bonnet springs up to absorb the collision better.

Post-crash safety: Mercedes-Benz emergency call system (part of optional COMAND Online system). If the restraint system detects a collision, it automatically makes a call via a connected telephone to the Mercedes-Benz emergency call centre with the position and data of the car. The centre then makes a voice connection to the car. The emergency call can also be made manually.

Post-crash safety: Rescue assistance. Mercedes-Benz has developed a range of measures that help to minimise the secondary consequences of an accident and facilitate

occupant rescue. These include automatic engine cut-off, self-activating hazard lights and emergency cabin lighting. In addition, the central locking system is automatically released in the event of an accident, and there are special crash joints between the front doors and wings that make it easier to open the doors after frontal collisions.

In addition, Mercedes-Benz provides a rescue guide for emergency services that can be downloaded from the Internet at www.mercedes-benz.co.uk/rescueguide

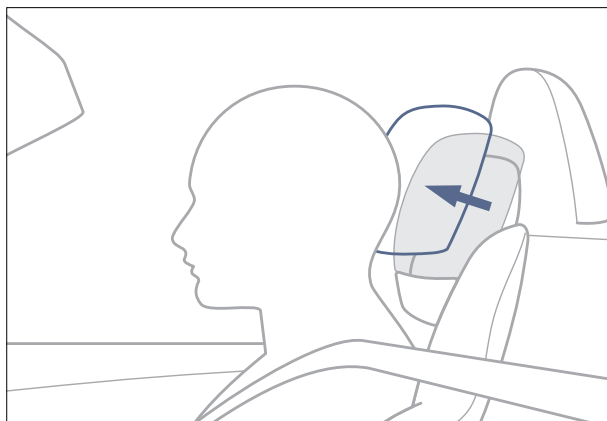

The Neck-Pro active head restraints reduce the risk of whiplash injuries in the event of a rear-end impact

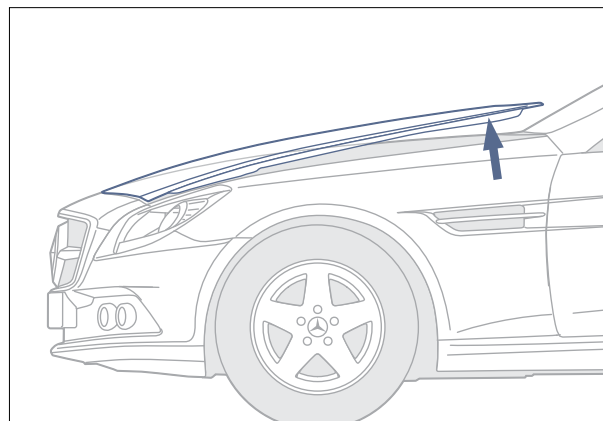

Active Bonnet is part of a range of measures by which Mercedes-Benz helps to protect more vulnerable road users



Multimedia systems

The entertainment and navigation options for the SLK include the COMAND Online system. It can be operated either via the central controller or the multi-function steering wheel – or hands-free thanks to Linguatronic voice control.

Harman Kardon® Logic 7® surround sound system (optional). With its subwoofer, 10-channel DSP amplifier and 3D spatial sound, this 400-watt 10-speaker system delivers a truly first-class audio experience combined with COMAND Online. It also maintains optimum clarity and enjoyment at all times, thanks to Dolby Digital 5.1 and speed-sensitive volume adjustment.

COMAND Online (optional). The system combines hard disk drive (HDD) navigation with a high-resolution 7-inch colour display for 3D map viewing. Multimedia functions include radio, DAB digital radio tuner, speed-sensitive volume control, music register with 10 GB of storage for audio files, free European map data updates¹ and live traffic information,¹ which provides precise, up-to-date traffic data for improved route planning and more accurately estimated time of arrival. A USB connection, SD memory card slot, Bluetooth® interface for hands-free access and the Media Interface allow connection to external data storage media. The DVD drive can play video and audio DVDs as well as CDs and MP3 files. The online feature allows access to the Internet and Mercedes-Benz apps via an Internet-enabled mobile phone, including Facebook, Internet radio, parking space search, special

destination searches via Google Street View or sending routes from Google™ maps to the vehicle, and hotel finder as well as news and weather reports. You can operate the system via the COMAND controller and the multi-function steering wheel, or simply use Linguatronic voice control. For comprehensive information on operating the vehicle and the COMAND Online system, the Digital Owner's Manual can be called up quickly and easily.

¹Free of charge for the first three years

Becker® Map Pilot navigation system (optional). With Becker® Map Pilot you'll always reach your destination as safely and quickly as possible. Map Pilot can be integrated with the Audio 20 radio/6-disc CD changer's central controller and display, turning it into a fully featured navigation system, and tailored to your needs by downloading additional functions and map data.



The Harman Kardon® Logic 7® surround sound system combined with COMAND Online brings high-end audio to the SLK cabin



Becker® Map Pilot navigation system can be integrated with and operated via the Audio 20 radio/6-disc CD changer





Electronic assistants

The SLK offers a range of intelligent assistants that help to make SLK driving safer and more convenient – be it on the open road or in tight parking spaces.

Speed Limit Assist (fitted with the optional COMAND Online system). Thanks to its front-mounted camera, Speed Limit Assist can read speed limit signs and display the permitted maximum speed in the car's instrument panel. It is particularly useful in areas where the speed limit varies or when passing through roadworks.

Parktronic with Parking Guidance (optional). Parking Guidance can help you to find and manoeuvre into parking spaces. At speeds of up to around 20 mph, it measures gaps in lines of parallel-parked cars using ultrasound sensors and alerts you as soon as it finds a suitably sized space. Once reverse is engaged, it then guides you in via a combination of acoustic signals and graphics in the instrument panel, showing the required steering angle and telling you when to turn the wheel. If the car is at an angle after the initial reversing manoeuvre, the system can also help you straighten up.

Parktronic, meanwhile, helps you to avoid low-speed knocks when manoeuvring in tight spaces. It uses up to ten sensors to monitor the areas to the front and rear of the car, alerting you via a visual warning if it detects the proximity of another vehicle or object. Once the distance to the object falls below approx. 35 centimetres, an audible signal is emitted, followed by a sustained warning sound if you continue to approach the obstacle.



Speed Limit Assist shows the current speed limit in the instrument panel and in the central COMAND Online display



Parking Guidance identifies suitable parking spaces and helps you to manoeuvre safely in



Open-top comfort

The SLK combines roadster thrills with refined comfort – and can be made even more relaxing via enhancements such as the optional Airguide wind deflector.

Airscarf (optional). Airscarf is a Mercedes-Benz innovation that lets you extend the open-top season. Thanks to subtly integrated vents in the head restraints, it can send a stream of warming air towards the head and neck of each occupant, enabling you to keep the roof down even in cooler weather.

Solar-reflective leather (optional; standard on SLK AMG Sport). All leather upholsteries (except *designo* leather) have a solar-reflective coating as standard. In bright sunshine, this special coating helps the seat surfaces to stay cooler, ensuring optimum comfort even on the hottest of days.

Airguide (optional). The Airguide wind deflector minimises draughts and cabin noise during open-top driving. It comprises specially designed Plexiglas® panels fixed to each of the roll-over bars. The transparent panels can be rotated and adjusted individually for driver and passenger, diverting the air flow away from the occupants and thus reducing turbulence around the head area. By improving the aeroacoustics, Airguide also helps to reduce cabin noise.

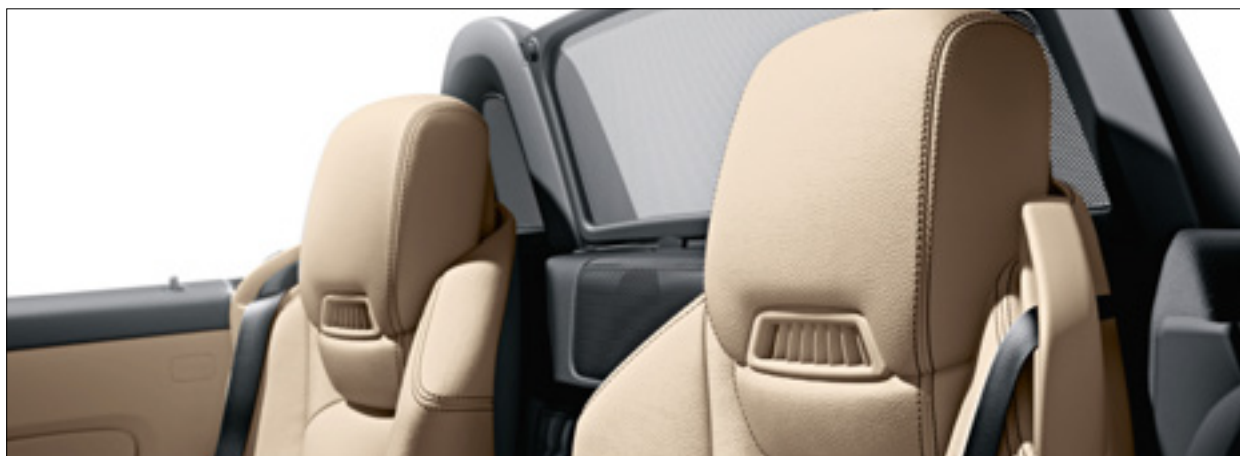

The Airscarf neck-level heating system lets you enjoy open-top driving even in cooler weather



The innovative Airguide wind deflector significantly reduces draughts with the roof open!

*Model shown in optional *designo* Hyacinth Red metallic paint (code 996). Please check with your Retailer for availability





Roof systems

The SLK redefines notions of roadster comfort. All roof variants provide all-weather protection and generous luggage space, while the panoramic vario-roof with Magic Sky Control offers another SLK first: switchable transparency with the roof closed.

Vario-roof (standard). The electrically operated vario-roof makes the SLK a genuine all-season roadster. It transforms the SLK from a two-seater coupé into an open-top roadster in less than 20 seconds. The vario-roof folds neatly away into the boot, leaving ample space for your luggage, and can be raised again just as quickly.

Panoramic vario-roof (optional). As an option, the SLK is available with a panoramic vario-roof that has a transparent glass insert in the centre part of the roof. This has a fixed transparency, giving you an open-top feeling even with the roof closed.

Panoramic vario-roof with Magic Sky Control (optional). Magic Sky Control enables the glass panoramic vario-roof to switch from transparent to tinted at the touch of a button, allowing you to choose between maximum light or effective protection from glare.



The SLK boot offers ample luggage space with the roof up or down



The panoramic vario-roof guarantees an airy cabin ambience even when closed¹



Magic Sky Control controls the transparency of the optional panoramic vario-roof



Climate control and interior lighting

The right cabin climate makes for a relaxed, alert driver and a contented passenger. Which is why the SLK lets each choose their own individual temperature settings.

Ambient interior lighting (optional). The Solar Red ambient interior lighting further enhances the cabin's sporty feel when driving at night. Comprising direct lighting for the centre console and door armrests plus indirect lighting for the door centre panels, it comes on as soon as you open the door then dims automatically once the door is closed. Its brightness can be adjusted, with five different settings for you to choose from. For an even wider range

of lighting possibilities, ambient interior lighting can be combined with the optional Interior Lighting Package.

Air conditioning (standard). The air conditioning system allows you to manually control your desired cabin temperature and air-flow. It includes an air recirculation function with automatically closing windows, residual engine heat utilisation, and a combined dust and activated

charcoal filter that captures particulates, reduces bad external odours and improves air quality.

Automatic climate control (optional). The two-zone automatic climate control system maintains separate preset temperatures for each side of the cabin, compensating automatically for external influences such as sunlight, air quality and humidity in the process. By allowing driver and passenger to tailor the cabin climate to their needs, it ensures both enjoy optimum comfort and helps the driver to stay relaxed and alert at all times.



Optional ambient lighting lends the interior a particularly athletic feel



> View price list



> View offers



> New C-Class



> Mercedes-Benz Magazine

Seats

The SLK comes with sports seats that meet the very highest standards of comfort, safety and ergonomics.

With their stylish, purposeful looks, the SLK's sports seats further emphasise the car's sporting intentions. What's more, they provide exceptional side support and stability even in fast cornering, keep you comfortable on long journeys, and help to protect you in the event of an accident. On the standard SLK, they are upholstered in Black cloth, with optional leather or nappa leather upholstery available in a variety of different colours with

contrast top-stitching. The SLK AMG Sport comes with leather upholstery, with nappa leather optionally available. With Black or Crystal Grey upholstery the seats have a vertical fluting design, red top-stitching to the seats and to some areas in the cabin, and red seat belts.

Memory function (part of the optional Memory Package). The memory function allows you to store driving positions for up to three different people. Each driver can then instantly call up their preferred settings for the seat and backrest position, the steering wheel and both exterior mirrors.



The SLK seats combine comfort, ergonomics and safety with sporty looks





SLK 55 AMG exterior

Three letters are all you need to maximise the sporty credentials of a Mercedes-Benz: AMG. It stands for premium technology, exclusiveness and dynamics – everything you'll enjoy in the SLK 55 AMG. → www.mercedes-benz.co.uk/amg

The SLK 55 AMG unites pure roadster fun with serious sportiness. Its strong exterior points to the powerful AMG engine. The V8 badge on the front wing is just one of many unique AMG design details. First up, the AMG grille in gloss black with single chrome louvre adds to the SLK 55 AMG's poise. AMG front apron, side skirts and

diffuser-style rear apron, plus side air vents with high gloss chromed finish all create a powerful stance.

AMG-specific daytime running lights, plus darkened front and rear lights are also part of the SLK's dynamic appearance. To conclude the sporty theme, there's

an AMG sports exhaust system with two sets of twin chromed tailpipes.

18" AMG 5-spoke alloy wheels painted in Titanium Grey with high sheen finish (235/40 front and 255/35 size rear wheels) come as standard. And for your own take on the SLK's maximum sporty appeal, choose from a wide selection of stunning optional extras as part of the AMG Performance Studio.



Powerful-looking twin chromed tailpipes and AMG rear skirt



5-spoke AMG alloy wheels, painted in Titanium Grey



> View price list



> View offers



> New C-Class



> Mercedes-Benz Magazine





> View price list



> View offers



> New C-Class



> Mercedes-Benz Magazine

SLK 55 AMG interior

The dynamic theme continues inside the SLK 55 AMG with a sporty interior design and premium luxurious materials.

Driving pleasure starts when seated. That's because the SLK 55 AMG is fitted with sports seats for maximum support during acceleration or when taking tight corners. For ultimate control, there is the AMG Performance

steering wheel with aluminium gear shift paddles and Direct Steering system. The AMG instrument panel with Racetimer and optional analogue IWC-designed clock create a unique AMG ambiance.

The cabin boasts the finest craftsmanship, premium materials and a desire for perfection. It offers the perfect surrounding for a true adventure – starting with the AMG door sills.



Everything under control: with AMG Performance steering wheel and instrument panel



Sporty meets luxurious: the optional AMG analogue clock designed by IWC

The interior features nappa leather upholstery as standard, in a choice of three beautiful colours.

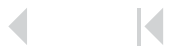



> View price list



> View offers



> New C-Class



> Mercedes-Benz Magazine





SLK 55 AMG technology

The engine is the heart of a sports car. In the SLK 55 AMG, it beats with the AMG 5.5-litre V8 with AMG Speedshift Plus 7G-Tronic automatic transmission. It delivers 421 hp (310 kW) and 540 Nm torque – and one of the best fuel consumption levels in its class.

A whole range of technical helpers provide the key to the excellent SLK 55 AMG driving dynamics. Whilst the Direct Steering system ensures precise steering, the Torque Vectoring Brakes help control critical corners. It targets the rear wheel closest to the corner with short, precise braking for a controlled turn-in of the car. This enhances both agility and driving safety. Equally, the AMG sports suspension with AMG-specific springs, dampers and

torsion bars contribute to excellent road holding. A high-performance braking system has been chosen to suit the incredibly powerful AMG engine. At the front, it features a 4-piston fixed caliper with drilled and internally ventilated 360 x 36 mm discs, whilst the rear has a single-piston sliding caliper with 330 x 22 mm discs. After all, enjoying the ride also requires stopping at the right moment.

AMG 5.5-litre V8 engine. 421 hp (310 kW) and 540 Nm torque even at lower revs – that’s a performance guaranteed to get the heart racing. However, when it comes to fuel consumption, the SLK shows its sensible side. The 5.5-litre V8 is one of the most efficient in its class. That’s because the Controlled Efficiency stop/start function and AMG Cylinder Management shut off four cylinders when they’re not required. All the while, the typical deep AMG sound remains unchanged.

AMG Speedshift Plus 7G-Tronic automatic transmission with double-declutch function. The AMG transmission ensures the quickest possible gear shifts with virtually seamless propulsion. The double-declutch function performs even swifter gear changes whilst reducing load changes in corners. Three driving modes – ‘Sport’, ‘Comfort’ or ‘Manual’ – provide the driving pleasure to suit individual tastes.

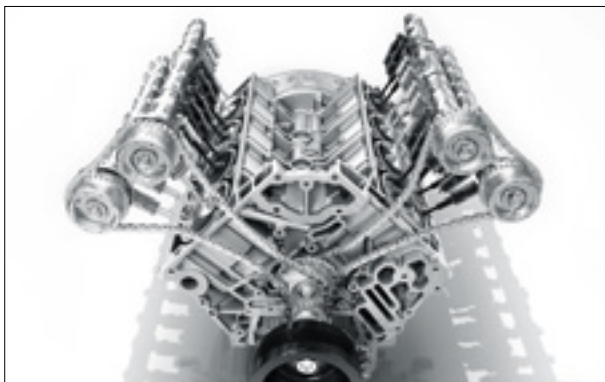

The AMG 5.5-litre V8 engine with AMG Cylinder Management ensures high performance with the lowest fuel consumption in its segment



Perfect propulsion: the engine delivers 421 hp (310 kW) and 540 Nm of torque combined with the AMG Speedshift Plus 7G-Tronic





AMG Performance Studio

The SLK 55 AMG is unique. For an even more personalised style, the AMG Performance Studio offers plenty of further options to express its sporty appeal.



AMG Performance Studio celebrates the SLK 55 AMG's sportiness. For example, the AMG Performance Package includes compound brakes for the front wheels, AMG Performance suspension, AMG rear-axle limited slip differential lock for optimum road holding, and AMG Performance steering wheel with nappa leather/Dinamica microfibre trim.

Equally expressive are the multi-spoke 18" AMG 10-spoke alloy wheels, in burnished Titanium Grey or in matt black with burnished rim flange. If you want to experience your SLK at an even higher level, choose the AMG Driver's Package for our one-day driver training which includes an increase in the top speed and attendance at an AMG 'Power & Passion' event.

Whatever you wish for, the AMG Performance Studio offers endless opportunities.

The AMG Performance Studio helps create an even more special SLK 55 AMG





> View price list



> View offers



> New C-Class



> Mercedes-Benz Magazine





> View price list



> View offers



> New C-Class



> Mercedes-Benz Magazine

Upholstery and trim



The Black interior scheme features either cloth upholstery in Black or leather upholstery in Black with grey top-stitching. The SLK 55 AMG features nappa leather as standard. For the SLK AMG Sport, there's also leather upholstery in Black with red top-stitching. The centre console is in brushed aluminium as standard; all other metal surfaces have an attractive chrome silver finish.



001



H76

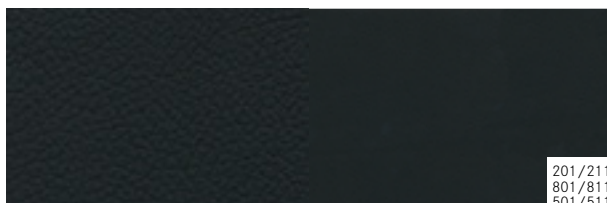

201/211
801/811
501/511



736



731

Black

- 001¹ Cloth
- 201²/211³ Leather
- 801^{2,4}/811⁵ Nappa leather
- 501^{2,6}/511⁵ Exclusive Nappa leather

Trim

- H76 Brushed aluminium (standard)
- 736 Black Ash wood (optional)
- 731⁷ Dark Brown Burr Walnut wood (optional)

¹Standard on SLK ²Optional on SLK ³Standard on SLK AMG Sport
⁴Standard for SLK 55 AMG ⁵Optional on SLK AMG Sport ⁶Optional for SLK 55 AMG
⁷Not available for SLK AMG Sport





> View price list



> View offers



> New C-Class



> Mercedes-Benz Magazine



The Sahara Beige interior scheme features leather upholstery in Sahara Beige with black top-stitching. For the SLK 55 AMG nappa leather is standard. The centre console is in brushed aluminium as standard; all other metal surfaces have an attractive chrome silver finish.

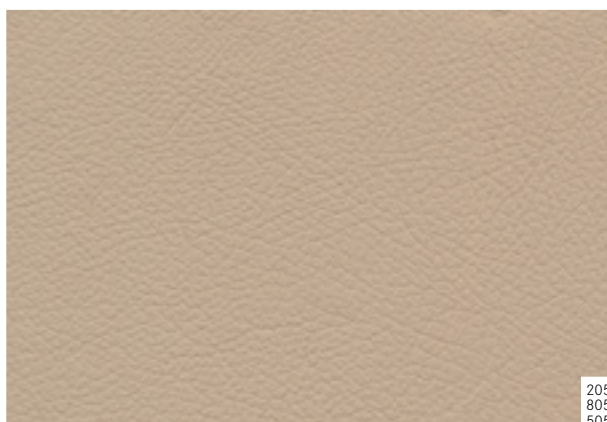

205
805
505

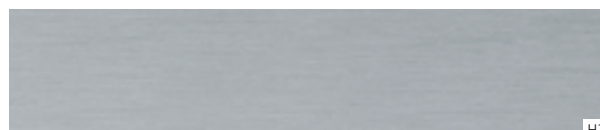

H76



736



731

Sahara Beige

205^{1,2} Leather

805^{3,4} Nappa leather

505^{4,5} Exclusive Nappa leather

Trim

H76 Brushed aluminium (standard)

736 Black Ash wood (optional)

731⁶ Dark Brown Burr Walnut wood (optional)

¹Optional on SLK ²Standard on SLK AMG Sport ³Standard on SLK 55 AMG

⁴Not available for SLK or SLK AMG Sport ⁵Optional for SLK 55 AMG

⁶Not available for SLK AMG Sport





> View price list



> View offers



> New C-Class



> Mercedes-Benz Magazine



The Crystal Grey interior scheme features leather upholstery in Crystal Grey with black top-stitching (red top-stitching for the SLK AMG Sport). The centre console is in brushed aluminium as standard; all other metal surfaces have an attractive chrome silver finish.

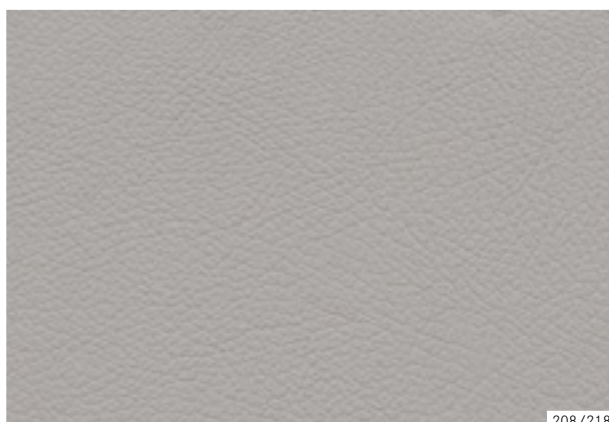

208/218

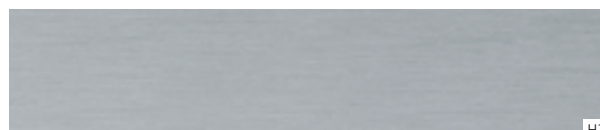

H76



736



731

Crystal Grey¹

208²/218³ Leather

Trim

H76 Brushed aluminium (standard)

736 Black Ash wood (optional)

731⁴ Dark Brown Burr Walnut wood (optional)

¹Not available for SLK 55 AMG ²Optional on SLK ³Standard on SLK AMG Sport ⁴Not available for SLK AMG Sport

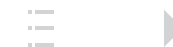



> View price list



> View offers



> New C-Class



> Mercedes-Benz Magazine



The Bengal Red colour scheme features either nappa leather or Exclusive Nappa leather upholstery in Bengal Red with black top-stitching. The centre console is in brushed aluminium as standard; all other metal surfaces have an attractive chrome silver finish.

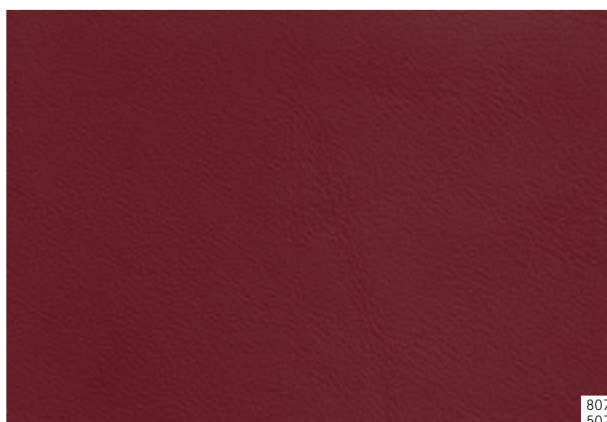

807
507



H76



736



731

Bengal Red

807^{1,2} Nappa leather

507^{2,3} Exclusive Nappa leather

Trim

H76 Brushed aluminium (standard)

736 Black Ash wood (optional)

731⁴ Dark Brown Burr Walnut wood (optional)

¹Standard for SLK 55 AMG ²Optional for SLK or SLK AMG Sport
³Optional for SLK 55 AMG ⁴Not available for SLK AMG Sport





> View price list



> View offers



> New C-Class



> Mercedes-Benz Magazine



The Nut Brown/Mocha Brown interior scheme features two-tone leather upholstery or Exclusive Nappa leather with Nut Brown seat facings, Mocha Brown side bolsters and top-stitching in contrasting Havanna. The centre console is in brushed aluminium as standard; all other metal surfaces have an attractive chrome silver finish. This colour scheme is not available for the SLK 55 AMG.

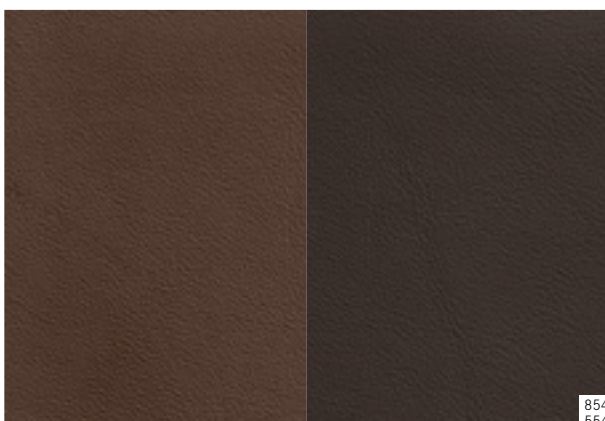

854
554



H76



736



731

Nut Brown/Mocha Brown¹

854² Nappa leather

554² Exclusive Nappa leather

Trim

H76 Brushed aluminium (standard)

736 Black Ash wood (optional)

731³ Dark Brown Burr Walnut wood (optional)

¹Not available for SLK 55 AMG ²Optional for SLK or SLK AMG Sport

³Not available for SLK AMG Sport

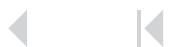



> View price list



> View offers



> New C-Class



> Mercedes-Benz Magazine

SLK AMG Sport exterior

Muscular, eye-catching and exceptionally agile, the SLK AMG Sport comes with added excitement as standard.

With AMG bodystyling – front, rear aprons and side skirts – the SLK AMG Sport is a roadster that always sets the pulse racing. Its headlamps with dark surrounds and dark tinted tail lights lend an even more eye-catching look, and there are also striking 18" AMG alloy wheels as standard.

What's more, the SLK AMG Sport delivers extra driving thrills too, thanks to 10 mm lower sports suspension, along with cross-drilled brake discs and 'Mercedes-Benz' lettering on the front calipers.



The SLK AMG Sport's eye-catching rear apron¹



18" AMG 5-spoke alloy wheels¹

¹Model shown in optional *designo* Hyacinth Red metallic paint (code 996). Please check with your Retailer for availability





> View price list



> View offers



> New C-Class



> Mercedes-Benz Magazine



The SLK AMG Sport offers added exclusivity and athleticism¹





> View price list



> View offers



> New C-Class



> Mercedes-Benz Magazine

SLK AMG Sport interior

With its purposeful yet luxurious cabin, the SLK AMG Sport is a joy for driver and passenger alike.

The exclusive SLK AMG Sport interior boasts eye-catching details such as red seat belts (Black or Crystal Grey upholstery only), AMG floor mats, and an instrument panel with a 'chequered flag' backplate. There's also

vertically fluted leather upholstery, with red top-stitching for the seats, steering wheel and gear shift gaiter¹ (Black or Crystal Grey upholstery only). The sports steering wheel also features perforated leather trim in the grip

area¹ (Black or Crystal Grey upholstery only) plus steering wheel shift paddles for automatic models.



Multi-function sports steering wheel with perforated leather trim and red top-stitching



Instrument backplate in 'chequered flag' design



Floor mats with 'AMG' lettering

¹With Black Nappa leather there is additional red top-stitching to door armrests; and with Black Exclusive Nappa leather to door armrests, upper dashboard and door beltlines





> View price list



> View offers



> New C-Class



> Mercedes-Benz Magazine





> View price list



> View offers



> New C-Class



> Mercedes-Benz Magazine

designo

For an even more individual SLK, choose from the range of *designo* paint finishes, upholstery and trim. → www.mercedes-benz.co.uk/designo

The *designo* options for the SLK combine the highest standards of quality and craftsmanship with exclusive colours and designs. Select from the range of 11 single-tone and 10 two-tone leather upholsteries for the seats and door centre panels. Sporty AMG carbon fibre and refined Black Piano Lacquer trim options are also available, along with red or silver seat belts, and Anthracite Dinamica microfibre windscreen frames.

For the exterior, there's a choice of five *designo* special paint finishes, including two distinctive matt finishes.



designo AMG carbon fibre trim





> View price list



> View offers



> New C-Class



> Mercedes-Benz Magazine

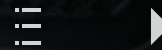



Standard equipment | Selection



Attention Assist



High resolution colour display in the instrument cluster (standard on SLK 350)¹



Clear-lens headlamps and LED daytime running lights



Air conditioning



LED tail lights



Electro-hydraulic vario-roof

¹Optional extra, included with COMAND Online or Driving Assistance Package (SLK 200, SLK 250 and SLK 250 CDI)





> View price list



> View offers



> New C-Class



> Mercedes-Benz Magazine



Audio 20 radio with integrated 6-disc CD changer



Ergonomic sports seats



Multi-function sports steering wheel with flattened lower section



USB port in the centre console



Stainless steel door sill panels



Roof controls and central controller





> View price list



> View offers



> New C-Class



> Mercedes-Benz Magazine

Optional extras | Selection



Panoramic vario-roof with or without Magic Sky Control



Becker® Map Pilot navigation system for Audio 20 radio/CD changer



Intelligent Light System¹



Ambient interior lighting



Exclusive Nappa leather



Harman Kardon® Logic 7® surround sound system

¹Model shown in optional *designo* Hyacinth Red metallic paint (code 996). Please check with your Retailer for availability





> View price list



> View offers



> New C-Class



> Mercedes-Benz Magazine



Airguide wind deflector, comprising twin Plexiglas® panels¹



Airscarf neck-level heating



COMAND Online system



Electric seat adjustment with memory function



Analogue clock



Keyless-Go





> View price list



> View offers



> New C-Class



> Mercedes-Benz Magazine

Alloy wheels



17" 5-spoke alloy wheels (standard on SLK, code 37R)



18" 5-spoke alloy wheels (optional on SLK, code R32)



17" 10-spoke alloy wheels (optional on SLK, code R35)



18" 5-twin-spoke alloy wheels, burnished two-tone Palladium Silver finish (optional on SLK, code 22R)





> View price list



> View offers



> New C-Class



> Mercedes-Benz Magazine



18" AMG 5-spoke alloy wheels, burnished finish (standard on SLK AMG Sport, code 782)



18" AMG 10-spoke alloy wheels, painted in Titanium Grey with burnished finish (optional on SLK 55 AMG, code 796)



18" AMG 5-spoke alloy wheels, painted in Titanium Grey with burnished finish (standard on SLK 55 AMG, code 790)



18" AMG 10-spoke alloy wheels, painted matt black with burnished-finish rim flange (optional on SLK 55 AMG, code 760)

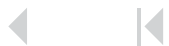



> View price list



> View offers



> New C-Class



> Mercedes-Benz Magazine

Retailer-fit accessories

Custom-designed for the SLK, our Retailer-fit accessories are the perfect way to make your roadster sportier and even more practical.

→ www.mercedes-benz.co.uk/accessories

The Mercedes-Benz Accessories range offers a variety of products ideally suited to your SLK. If your vehicle is parked up for any length of time, our highly practical AMG indoor car cover will protect the bodywork from scratches and dust. Your SLK deserves to be cherished.

A very practical feature that puts your mind at rest is our Tracker™. If your SLK-Class is ever stolen, VHF (Very High Frequency) technology tracks down your car's location – even if it's held in a garage or an underground car park.

Whether you are taking cold drinks, a picnic lunch or baby food with you, the cool bag cools to minus 2 degrees Celsius, making it the perfect accessory for any outing.

The cool bag holds up to 12 litres and is powered via a cigarette lighter or 12V socket.

For more details about these and other SLK accessories, please see the relevant brochure or speak to your local Mercedes-Benz Retailer.



Bonnet trim with high gloss chromed fins



Flat boot floor tray





> View price list



> View offers



> New C-Class



> Mercedes-Benz Magazine





Services

Test drive. You've seen the pictures, you've read the facts. Now all that's missing is to experience your dream Mercedes in the flesh. Which is why we invite you to take it for a spin. See it with your own eyes. Rev up the engine, and feel how your chosen Mercedes hugs the road. Relax in style or play with a whole host of exciting onboard technology. Contact your Mercedes-Benz Retailer for a test drive, or simply go online and visit www.mercedes-benz.co.uk/testdrive. We can't wait to see you in the driving seat.

Mercedes-Benz Finance. At Mercedes-Benz Finance, our single-minded aim is to provide optimum financial solutions for all those who share the Mercedes-Benz philosophy of absolute commitment to quality. Whether you are a private customer or a business user, our finance and leasing packages can be tailored to meet your individual needs. For further information on Mercedes-Benz Finance, please contact your local Mercedes-Benz Retailer.



Mercedes-Benz Insurance offers a fully comprehensive 5-star Motor Insurance policy, rated by Defaqto, a leading UK independent financial research company. Our policy is specifically designed to provide the cover you would expect from Mercedes-Benz. For a quotation, please call 0345 600 2180.¹

Interactive Owner's Manual. The website also offers an interactive tour, enabling you to take a closer look at your desired model. This simulation is the ideal way to acquaint yourself with your dream car. You can view key functions in detail, gain an insight into the car's inner workings or look at the benefits of each model. For further details, visit www.mercedes-benz.co.uk/slkclassmanual

¹Mercedes-Benz Motor Insurance is underwritten by Aviva Insurance Limited. For joint protection, calls may be recorded and/or monitored. All calls are charged at local rate. We may decline to quote in some circumstances



> View price list



> View offers



> New C-Class



> Mercedes-Benz Magazine

Roadside Assistance. Rest assured that should you ever need help, Mercedes-Benz Roadside Assistance is there for you. In the unlikely event of a technical breakdown² you can rely on the Mercedes-Benz Roadside Assistance Team – anywhere in Europe. Simply phone our Customer Assistance Centre on Freephone +44 (0) 207 975 7077,³ where our specialists will organise assistance for you. Mercedes-Benz will also assist you in the event of a minor mishap preventing you from driving your vehicle.⁴ Whether you lose your key, run out of fuel, or your vehicle is damaged due to an accident or vandalism,⁴ Mercedes-Benz ensures that you still reach your destination. Often, the problem can be rectified on the spot, but if this is not possible, we will naturally ensure that your vehicle is taken to the nearest Mercedes-Benz Retailer to get you back on the road as quickly as possible.

²Cover is initially valid for your vehicle for four years from the date of first registration. This can be extended from the fifth year, up to a maximum of 30 years, on completion of each scheduled maintenance service, providing that this service is carried out by a Mercedes-Benz Retailer, and recommended items are completed

³If your mobile phone provider charges for Freephone numbers please call 0207 975 7077

⁴Minor mishap cover is provided at the absolute discretion of Mercedes-Benz

Service Care. To keep a tight grip on costs, Mercedes-Benz offers service plans to cover the costs of an annual service, for two, three and four years. Plans can be paid monthly with interest-free instalments or alternatively, if you pay upfront, should you sell your vehicle any remaining services will be transferred to the new owner. All routine maintenance and additional items are covered. To find out more, please contact your local Retailer or visit www.mercedes-benz.co.uk/servicecare

Mercedes-Benz World at Brooklands. Put our latest vehicles to the test at Mercedes-Benz World. Book an AMG Driving Experience on our handling circuits or tackle the deep water crossings and axle-twisting obstacles on our 10 acre off-road course. Under 16s can drive on the historic Brooklands circuit, while three to five year olds can become Little Learners on our indoor driving circuit. Discover automotive legends like the original 300 SL Gullwing, Formula 1® cars and the UK's largest collection of Mercedes-Benz and AMG models under one roof. Relax and refuel in Café 1886, or enjoy the delicious menu and elegant surroundings of the Gullwing Bistro. With three floors of interactive attractions and exhibitions, free entry and free parking every day, the whole family will enjoy an adrenaline-fuelled day out at Mercedes-Benz World. To book a Driving Experience call 0370 400 4000 or for more information visit www.mercedes-benzworld.co.uk

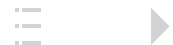



Dimensions

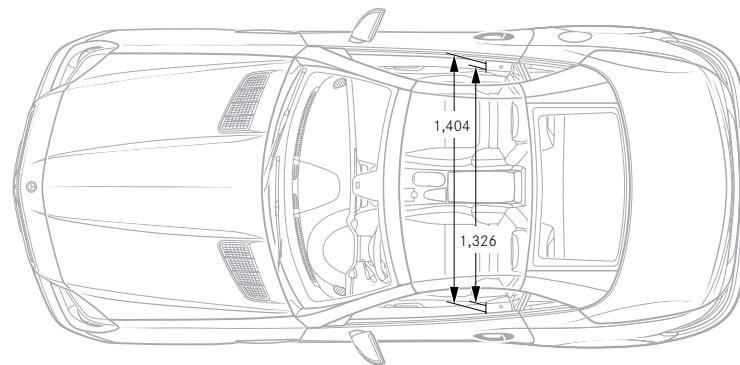
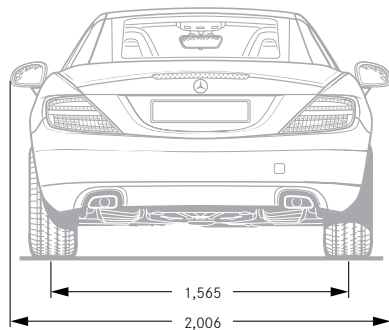
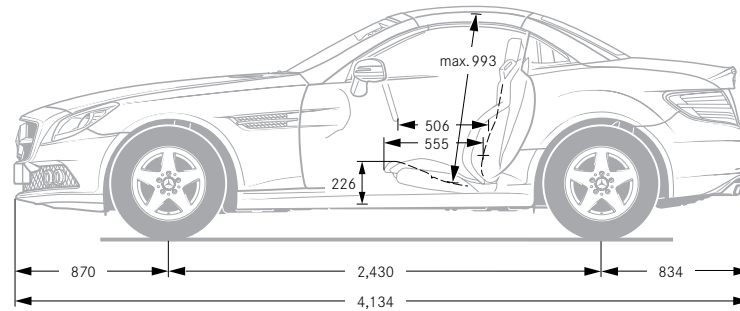
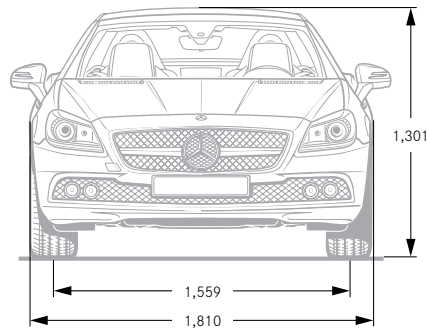

All measurements in millimetres. The dimensions shown are mean values and apply to standard-specification, unladen vehicles





Technical specifications

Petrol engines

	SLK 200	SLK 250	SLK 350	SLK 55 AMG
Arrangement/cylinders/valves	in-line/4/16	in-line/4/16	V/6/24	V/8/32
Total displacement – cc	1,796	1,796	3,498	5,461
Rated output ¹ – hp (kW) at rpm	184 (135)/5,250	204 (150)/5,500	306 (225)/6,500	421 (310)/6,800
Rated torque ¹ – Nm at rpm	250/1,800–4,600	310/2,000–4,300	370/3,500–5,250	540/4,500
Acceleration 0–62 mph – sec (auto.)	7.3 (7.0)	6.5 (6.6)	– (5.6)	– (4.6)
Top speed, approx. – mph (auto.)	149 (147)	152 (151)	– (155) ²	– (155) ²
Fuel consumption ³ – mpg (auto.)				
Urban	30.4 (32.8)	28.8 (32.5)	– (28.5)	– (23.5)
Extra-urban	53.3 (53.3)	48.7 (52.3)	– (51.4)	– (45.6)
Combined	41.5 (43.5)	38.7 (42.8)	– (39.8)	– (33.6)
CO ₂ emissions, combined ³ – g/km (auto.)	158 (151)	169 (153)	– (167)	– (195)
EU emissions standard	EU5	EU5	EU5	EU6
Fuel tank capacity/reserve (approx.) – l	60/8	60/8	60/8	70/9
Boot capacity – l				
with roof closed	335	335	335	335
with roof open	225	225	225	225
Turning circle – m	10.52	10.52	10.52	10.53
Kerb weight ⁴ – kg (auto.)	1,435 (1,470)	1,475 (1,500)	– (1,540)	– (1,690)
Perm. GVW – kg (auto.)	1,750 (1,785)	1,790 (1,815)	– (1,855)	– (1,910)

¹Figures according to Directive 80/1269/EEC in the currently applicable version ²Electronically limited

³The figures shown were obtained in accordance with the prescribed measuring process (Regulation [EC] 715/2007 in the currently applicable version). The figures are not based on an individual vehicle and do not constitute part of the product offer; they are provided solely for purposes of comparison between different vehicle models

⁴Figures according to Directive 92/21/EC, version 95/48/EC (kerb weight with fuel tank 90% full, driver, 68 kg, and luggage, 7 kg) for standard-specification vehicles. Optional extras and accessories will generally increase this figure and reduce the payload capacity accordingly



**Diesel engine**

Arrangement/cylinders/valves
Total displacement – cc
Rated output ¹ – hp (kW) at rpm
Rated torque ¹ – Nm at rpm
Acceleration 0–62 mph – sec (auto.)
Top speed, approx. – mph (auto.)
Fuel consumption ³ – mpg (auto.)
Urban
Extra-urban
Combined
CO ₂ emissions, combined ³ – g/km (auto.)
EU emissions standard
Fuel tank capacity/reserve (approx.) – l
Boot capacity – l
with roof closed
with roof open
Turning circle – m
Kerb weight ⁴ – kg (auto.)
Perm. GVW – kg (auto.)

SLK 250 CDI

in-line/4/16
2,143
204 (150)/4,200
500/1,600–1,800
– (6.7)
– (151)
– (45.6)
– (65.7)
– (56.5)
– (132)
EU5
60/8
335
225
10.52
– (1,590)
– (1,905)

¹Figures according to Directive 80/1269/EEC in the currently applicable version ²Electronically limited³The figures shown were obtained in accordance with the prescribed measuring process (Regulation [EC] 715/2007 in the currently applicable version). The figures are not based on an individual vehicle and do not constitute part of the product offer; they are provided solely for purposes of comparison between different vehicle models⁴Figures according to Directive 92/21/EC, version 95/48/EC (kerb weight with fuel tank 90% full, driver, 68 kg, and luggage, 7 kg) for standard-specification vehicles. Optional extras and accessories will generally increase this figure and reduce the payload capacity accordingly



Paint finishes

The highly durable nature of the Mercedes-Benz paint system makes it one of the best clear coats available in the automotive industry. A highly dense molecular structure provides the key to the extremely resilient paint, regardless whether it's non-metallic or metallic, giving the surface a longer lasting, more intense shine.

Non-metallic paints¹

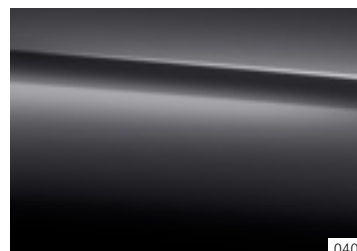

Non-metallic paints¹

- 040 Black
- 149 Polar White
- 590 Fire Opal

Metallic paints^{2,3}

- 197 Obsidian Black
- 755 Tenorite Grey
- 775 Iridium Silver
- 792 Palladium Silver
- 890 Cavansite Blue
- 963 Indium Grey
- 988 Diamond Silver

designo paints²

- 799 designo Diamond White
- 996 designo Hyacinth Red⁴

Metallic paints^{2,3}

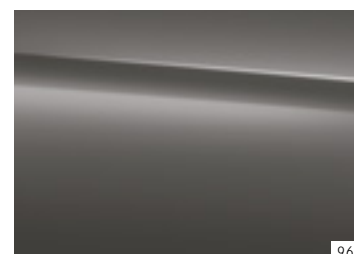
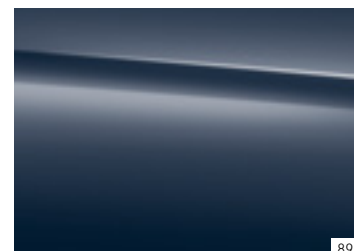
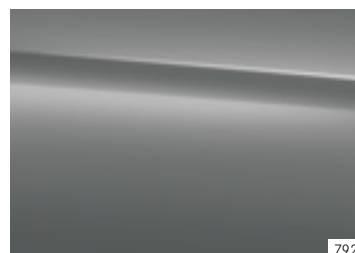
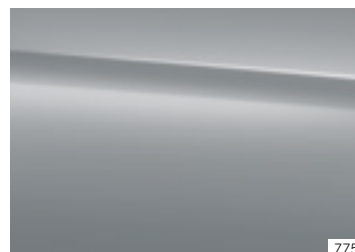
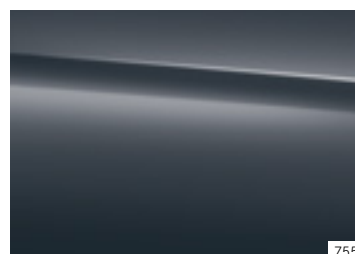
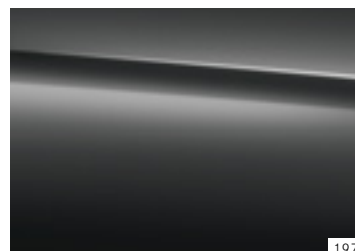

designo paints²



¹Standard ²Optional ³Standard on SLK 55 AMG
⁴Please contact your Retailer for availability





> View price list



> View offers



> New C-Class



> Mercedes-Benz Magazine

Take-back of end-of-life vehicles. Coming full circle. At the end of its long life, you can return your SLK-Class to us for environment-friendly disposal in accordance with the EC End-of-Life Vehicle Directive.¹ But that day lies a long way off.

¹Applies in accordance with national regulations to vehicles up to 3.5t permissible gross weight. The SLK-Class has met the statutory regulations governing the suitability of the vehicle's design for reuse and recycling for a number of years now. A network of vehicle take-back depots and dismantlers has been established which will process your vehicle in an environment-friendly manner. The ways in which both vehicles and parts can be recovered are subject to ongoing development and improvement. Consequently, the SLK-Class will be able to comply with any future increases in the recycling quota within the stipulated time limits. Further information is available at www.mercedes-benz.co.uk or by calling 0333 222 0500.

Please note: this online version of the printed brochure may contain abridged copy or other content changes. The manufacturer reserves the right to make changes to the design, form, colour and specification during the delivery period, provided these changes, while taking into account the interests of the vendor, can be deemed reasonable with respect to the purchaser. Where the vendor or the manufacturer uses symbols or numbers to describe an order or the subject of an order, no rights may be derived solely from these. The illustrations may show accessories and items of optional equipment which are not part of standard specification. Colours may differ slightly from those shown in the brochure, owing to the limitations of the printing process. This brochure has been compiled by Daimler AG of Germany and is distributed internationally. It provides a general indication of the range of models, features, optional extras and/or colours available in various countries. Some of the models, features, optional extras and/or colours shown may not be available in your country or may only be available in a different specification. Additionally some models, features, optional extras and/or colours may only be available in combination with others. For current and more specific information in relation to the range of models, features, optional extras and/or colours available in your country, and their pricing, you should contact your nearest authorised Mercedes-Benz Retailer. E&OE. www.mercedes-benz.co.uk

Daimler AG, Mercedesstr. 137, 70327 Stuttgart MS/MAA 6701 · 0810 · 88-06/0614

Follow us on the following social media channels:



<https://www.facebook.com/MercedesBenzUK>



<https://twitter.com/mercedesbenz>



<https://www.youtube.com/user/mercedesbenz>



<https://instagram.com/mercedesbenz>

