



[View offers](#)



[Book a test drive](#) [AMG test drive](#)



[Find a Retailer](#)



[View the Range Guide](#)

M-Class.

Effective from 1 April 2015.



Mercedes-Benz



> View offers



Book a > test drive > AMG test drive



> Find a Retailer



> View the Range Guide

Contents

Model prices	11	Entertainment package	31	Pricing summary for Premium package	45
Finance offers	12	Sports package	32	AMG optional equipment	46
Model lines	16	Off-Road package	33	Genuine Accessories	50
Standard equipment	20	Driving Assistance package	34	Colours and materials	54
Wheels	25	Optional equipment	35	Technical data	58
Exclusive package	27	ML 63 AMG 4MATIC	38	Road Fund Licence	62
Premium and Premium Plus packages	28	AMG standard equipment	40	Services and insurance	63
Pricing summary for Premium and Premium Plus packages	30	Premium package	44	Mercedes-Benz Finance	64



> View offers



Book a > test drive > AMG test drive



> Find a Retailer



> View the Range Guide

The hard facts to melt your heart

At Mercedes-Benz we appreciate the importance of detail. Over the following pages you'll find model prices and a breakdown of standard and optional equipment, as well as details of the comprehensive services and benefits that are available to every Mercedes-Benz driver.

See Mercedes-Benz in a new light. Now is the time to get yourself behind the wheel of an M-Class. Choose from a number of attractive finance offers. Please see pages 12–15 for further details, or visit www.mercedes-benz.co.uk/offers

Of course, some things have to be experienced to be truly appreciated, such as the qualities that set a Mercedes-Benz apart. Which is why we'd like to invite you for a test drive at your local Mercedes-Benz Retailer. Alternatively, you can make arrangements by visiting www.mercedes-benz.co.uk/testdrive

For more information visit www.mercedes-benz.co.uk or call 0808 156 6606.



[View offers](#)



[Book a test drive](#) [AMG test drive](#)



[Find a Retailer](#)



[View the Range Guide](#)

4





> View offers



Book a > test drive > AMG test drive



> Find a Retailer



> View the Range Guide





> View offers



Book a > test drive > AMG test drive



> Find a Retailer



> View the Range Guide

6





[View offers](#)



[Book a test drive](#) [AMG test drive](#)



[Find a Retailer](#)



[View the Range Guide](#)





> View offers



Book a > test drive > AMG test drive



> Find a Retailer



> View the Range Guide

8





> View offers



Book a > test drive > AMG test drive



> Find a Retailer



> View the Range Guide





> View offers



Book a > test drive > AMG test drive



> Find a Retailer



> View the Range Guide

10





Model prices

Engine	Model line	Transmission	CO ₂	Basic RRP excl. VAT (£)	Total RRP incl. VAT (£)	Road Fund Licence (£) ¹	Rec. OTR price (£) ²	P11D value (£)	BiK tax rate 2015/16 (%)
ML 250 BlueTEC 4MATIC Diesel – 2,143 cc, 4-cylinder, 204 hp/150 kW	SE Executive	7G-TRONIC PLUS 7-speed automatic	163	39,450.00	47,340.00	180.00	48,190.00	47,955.00	30
	AMG Line	7G-TRONIC PLUS 7-speed automatic	163	41,666.67	50,000.00	180.00	50,850.00	50,615.00	30
ML 350 BlueTEC 4MATIC Diesel – 2,987 cc, 6-cylinder, 258 hp/190 kW	SE Executive	7G-TRONIC PLUS 7-speed automatic	189	41,816.67	50,180.00	490.00	51,340.00	50,795.00	35
	AMG Line	7G-TRONIC PLUS 7-speed automatic	189	44,033.33	52,840.00	490.00	54,000.00	53,455.00	35
AMG									
ML 63 AMG 4MATIC Petrol – 5,461 cc, 8-cylinder, 525 hp/386 kW	AMG	AMG SPEEDSHIFT PLUS 7G-TRONIC 7-speed automatic	276	71,029.17	85,235.00	1,100.00	87,005.00	85,850.00	37

¹A different first year rate of Vehicle Excise Duty (Road Fund Licence) applies for new cars. Please refer to page 62 for the relevant rate for the second and subsequent years

²Recommended on-the-road price: these prices reflect the Road Fund Licence applicable to the standard model plus £670.00 additional costs necessary to put your car on the road.

Included are a standard UK delivery charge (£540.00 incl. VAT), new vehicle registration fee (£55.00), number plates (£25.00 incl. VAT) and fuel (£50.00 incl. VAT). VAT is calculated at the standard rate of 20%



Mercedes-Benz Finance

It comes with a specification list worth exploring

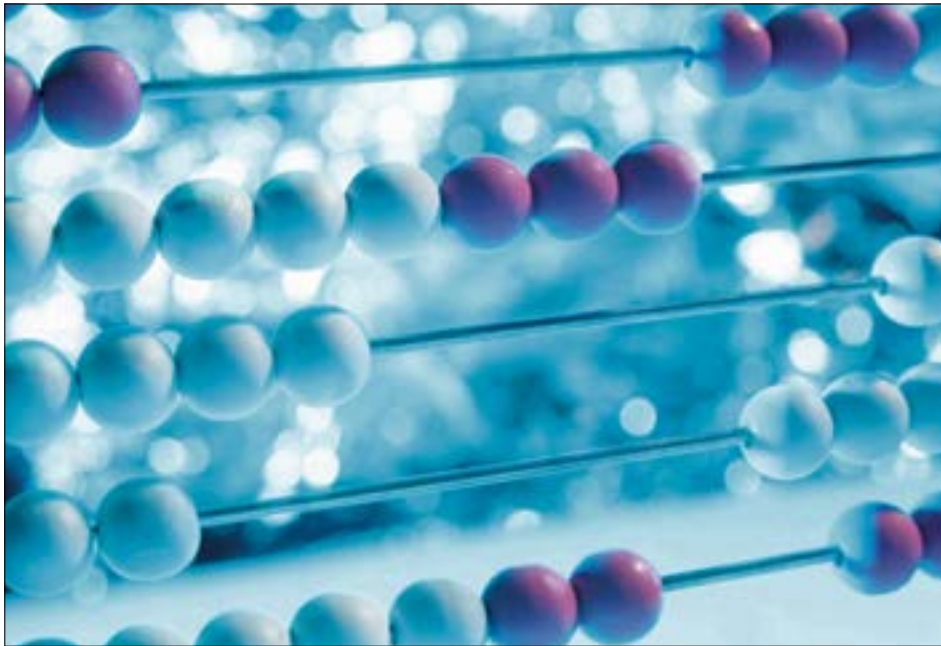

ML 250 BlueTEC 4MATIC SE Executive (representative example)

36 monthly payments of ¹	£499.00
On-the-road price	£48,190.00
Customer deposit	£7,499.00
Retailer deposit contribution	£4,991.14
Duration of agreement	36 months
Optional purchase payment ²	£22,625.00
Purchase activation fee ²	£10.00
Amount of credit	£35,699.86
Total amount payable ³	£53,089.14
Representative APR	5.7% APR
Fixed interest rate	5.52%

**Example offer –
5.7% APR Representative**

	Automatic	Metallic	On-the-road price	Retailer deposit contribution	Customer deposit	36 monthly payments of ¹
ML 250 BlueTEC 4MATIC AMG Line	●	●	£50,850.00	£4,991.14	£7,520.77	£539.00
ML 350 BlueTEC 4MATIC AMG Line	●	●	£54,000.00	£4,991.14	£8,138.50	£579.00

● Standard equipment

Mercedes-Benz Service Care

- Mercedes-Benz trained Technicians
- Maintained by Mercedes-Benz Retailers
- Meets requirements of Mercedes-Benz Agility finance agreement

Mercedes-Benz Motor Insurance

- 24/7 UK accident recovery
- We use Mercedes-Benz GenuineParts
- To qualify for up to 10% discount online, go to www.mercedes-benz.co.uk/motorinsurance
- Alternatively, call Mercedes-Benz Motor Insurance now on **0345 600 2180⁴** for an annual quote

We may decline to quote in some circumstances. Mercedes-Benz Motor Insurance is underwritten by Aviva Insurance Limited

Whilst these offers are only available with Mercedes-Benz Finance, our Mercedes-Benz Retailers do arrange finance on behalf of other finance companies as well

Orders/credit approvals on selected M-Class models between 1 October and 31 December 2015, registered by 31 March 2016; excluding ML 63 AMG models. Some combinations of features/options may not be available.

Please contact your local Mercedes-Benz Retailer for availability

¹Based on a Mercedes-Benz Agility agreement and 10,000 miles per annum. Vehicle condition, excess mileage and other charges may be payable. Quotations available on request for alternative contract lengths and mileages.

Guarantees and indemnities may be required. Terms and Conditions apply. Credit provided subject to status by Mercedes-Benz Financial Services UK Ltd, MK15 8BA

²Payable if you exercise the option to purchase the car. Guaranteed future value if you choose to hand back the vehicle at the end of the contract³Includes optional purchase payment, purchase activation fee and Retailer deposit contribution ⁴Calls are charged at local rate and may be recorded



Mercedes-Benz Finance

Even the finance offer is beautifully put together

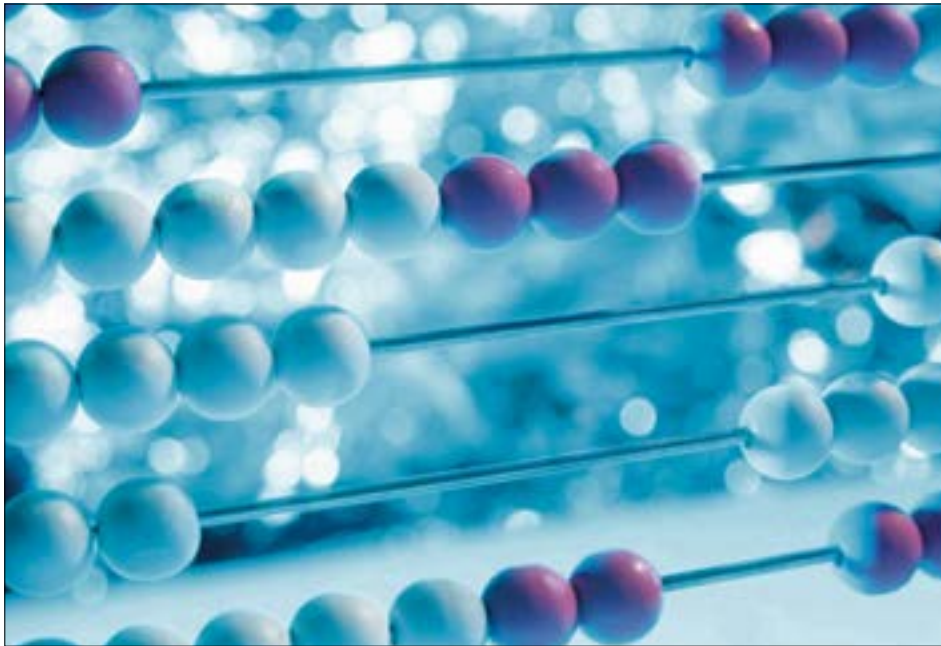

ML 63 AMG 4MATIC (representative example)

36 monthly payments of ¹	£999.00
On-the-road price	£87,005.00
Customer deposit	£10,999.00
Retailer deposit contribution	£10,358.78
Duration of agreement	36 months
Optional purchase payment ²	£38,425.00
Purchase activation fee ²	£10.00
Amount of credit	£65,647.22
Total amount payable ³	£95,756.78
Representative APR	5.7% APR
Fixed interest rate	5.52%



Example offer – 5.7% APR Representative

	Automatic	Metallic	On-the-road price	Retailer deposit contribution	Customer deposit	36 monthly payments of ¹
ML 63 AMG 4MATIC	●	●	£87,005.00	£10,358.78	£10,999.00	£999.00

● Standard equipment

Mercedes-Benz Service Care

- Mercedes-Benz trained Technicians
- Maintained by Mercedes-Benz Retailers
- Meets requirements of Mercedes-Benz Agility finance agreement

Mercedes-Benz Motor Insurance

- 24/7 UK accident recovery
- We use Mercedes-Benz GenuineParts
- To qualify for up to 10% discount online, go to www.mercedes-benz.co.uk/motorinsurance
- Alternatively, call Mercedes-Benz Motor Insurance now on **0345 600 2180⁴** for an annual quote

We may decline to quote in some circumstances. Mercedes-Benz Motor Insurance is underwritten by Aviva Insurance Limited

Whilst these offers are only available with Mercedes-Benz Finance, our Mercedes-Benz Retailers do arrange finance on behalf of other finance companies as well

Orders/credit approvals on ML 63 AMG models between 1 October and 31 December 2015, registered by 31 March 2016; excluding non-AMG models. Some combinations of features/options may not be available.

Please contact your local Mercedes-Benz Retailer for availability

¹Based on a Mercedes-Benz Agility agreement and 10,000 miles per annum. Vehicle condition, excess mileage and other charges may be payable. Quotations available on request for alternative contract lengths and mileages.

Guarantees and indemnities may be required. Terms and Conditions apply. Credit provided subject to status by Mercedes-Benz Financial Services UK Ltd, MK15 8BA

²Payable if you exercise the option to purchase the car. Guaranteed future value if you choose to hand back the vehicle at the end of the contract

³Includes optional purchase payment, purchase activation fee and Retailer deposit contribution ⁴ Calls are charged at local rate and may be recorded



> View offers



Book a > test drive > AMG test drive



> Find a Retailer



> View the Range Guide

16

M-Class SE Executive





> View offers



Book a > test drive > AMG test drive



> Find a Retailer



> View the Range Guide

There is little chance of the M-Class SE Executive going unnoticed. The SE Executive is equipped with chrome-style front and rear apron trims, and LED daytime running lights are standard, as are 19" 5-spoke alloy wheels. The SE Executive also comes with a Mirror package that includes electrically folding exterior mirrors as well as auto-dimming rear-view and driver's side mirrors. Inside, brushed aluminium trim is standard, with four different wood trims available as options. Seats are upholstered in ARTICO leather¹ in either

black, almond beige or alpaca grey, with leather upholstery also available. Front seats offer full electric adjustment and the driver's seat provides electric, four-way lumbar support. True to its name, the SE Executive also features privacy glass for added sophistication. It's also reassuring to know that you can rely on the COMAND Online system, fitted as standard, wherever you venture.

Exterior

Mirror package – automatically dimming rear view and driver's door mirrors, and electrically folding exterior mirrors

19" 5-spoke alloy wheels with 255/50 tyres

Active Parking Assist with PARKTRONIC

Courtesy lighting on underside of door mirrors

Front and rear apron trims, chrome style

Headlamps – Intelligent Light System

Interior

COMAND Online system with Media Interface

Electric windows

Four-way electric lumbar support for driver's seat

Front seats – full electric adjustment (backrest, height and longitude)

Privacy glass

Split folding rear seats – 1/3:2/3, with manual back adjustment

THERMATIC – automatic climate control

Trim and Upholstery

Brushed light aluminium



ARTICO leather¹ – black



ARTICO leather¹ – almond beige



ARTICO leather¹ – alpaca grey



¹Man-made leather with perforations in seat centre panel



> View offers



Book a > test drive > AMG test drive



> Find a Retailer



> View the Range Guide

18

M-Class AMG Line





The M-Class AMG Line is quite a head turner. It boasts an even sleeker, sportier look as it comes with all-round AMG bodystyling and eye-catching 20" AMG 5-spoke alloy wheels. This athletic look is underscored by chrome-style front and rear apron trims, aluminium-finish roof rails and body-coloured side trim panels. Privacy glass from the B-pillar backwards completes the look. Once inside, the AMG Line delivers on its sporty credentials with the 4-spoke sports steering wheel with perforated grip areas, rubber-studded stainless steel sports pedals and black floor mats with leather edging and

'Mercedes-Benz' badges. The beauty within, however, has to be the upholstery: sports seats in ARTICO leather¹/black DINAMICA microfibre.² The standard COMAND Online system with Media Interface includes 3D navigation and ensures you're always entertained. And for added comfort, the AMG Line is easy to park with the standard Active Parking Assist with PARKTRONIC. It doesn't just pick the right parking spot, but will also guide you in with ease.

Exterior

- 20" AMG 5-spoke alloy wheels
- Active Parking Assist with PARKTRONIC
- AMG bodystyling – front and rear apron, side skirts
- Direct Steering
- EASY-PACK powered tailgate – opens and closes automatically
- Headlamps – Intelligent Light System

Interior

- COMAND Online system with Media Interface
- Door centre panels with ribbed design in ARTICO leather¹

- Front seats – full electric adjustment and four-way electric lumbar support
- Split folding rear seats 1/3:2/3 with manual back adjustment
- Sports seats with ARTICO leather¹/DINAMICA microfibre²
- THERMATIC – automatic climate control

Trim and Upholstery

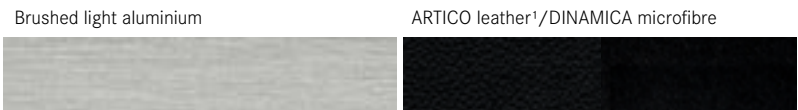

¹Man-made leather ²Please refer to page 25 for further information regarding single-tone and two-tone leather upholstery options



Standard equipment

Item	SE Executive	AMG Line
Transmission and Suspension		
7G-TRONIC PLUS 7-speed automatic transmission with steering column gear selector, steering wheel gearshift paddles (Direct Select) and SPEEDTRONIC cruise control	●	●
ECO start/stop function	●	●
Off-road switch – primes systems for off-road driving (ML 350 BlueTEC 4MATIC only)	●	●
Permanent four-wheel drive	●	●
Steel suspension – lowered (ML 250 BlueTEC 4MATIC only)	●	●
Steel suspension (ML 350 BlueTEC 4MATIC only)	●	●
Steering		
4-spoke multi-function, trimmed in nappa leather	●	–
4-spoke multi-function sports steering wheel, trimmed in nappa leather with perforated grip areas	–	●
Direct Steering	●	●
Steering column – manually adjustable for height and reach	●	●

Item	SE Executive	AMG Line
Exterior		
Mirror package – automatically dimming rear view and driver’s door mirrors, and electrically folding exterior mirrors	●	●
18"/19" sports brakes with perforated front discs and brake caliper covers with ‘Mercedes-Benz’ lettering	–	●
Active Parking Assist with PARKTRONIC PARKTRONIC monitors the front and rear end whilst the driver is manoeuvring the vehicle and gives a warning if the risk of a collision is detected. Active Parking Assist makes it easier to find a parking space and also automatically steers the vehicle into parking spaces	●	●
AMG bodystyling – front and rear apron, side skirts	–	●
Courtesy lighting on underside of door mirrors	●	●
Diesel Particulate Filter (DPF)	●	●
EASY-PACK powered tailgate – opens and closes automatically	●	●
Front and rear apron trims, chrome style	●	●
Headlamps – Intelligent Light System Bi-xenon headlamps, Active Light System, automatic headlamp range adjustment, cornering light function, LED indicators, LED signature lights and headlamp wash	●	●



Item	SE Executive	AMG Line
Exterior (continued)		
Heated windscreen washer	●	●
LED daytime running lamps	●	●
LED rear lamps	●	●
Privacy glass – dark glass from B-pillar backwards	●	●
Radiator grille with three chromed louvres	●	●
Rain-sensing wipers	●	●
Rear bumper with integrated reflectors	●	●
Rear screen wash/wiper	●	●
Roof rails – aluminium finish	●	●
Scratch guard on load compartment sill – chrome	●	●
Tinted glass – green	●	●
TIREFIT tyre-sealant kit	●	●

Item	SE Executive	AMG Line
Interior		
12V socket in load compartment and passenger compartment – front and rear	●	●
Centre armrests – front (with stowage) and rear	●	●
Cup holders – front (2) and rear (2)	●	●
Door centre panels with ribbed design in ARTICO leather ¹	–	●
Electric windows (4)	●	●
Front seats – full electric adjustment (backrest, height and longitude) with four-way electric lumbar support for driver's seat	●	●
Front seats – heated	●	●
Load-securing rings (4)	●	●
Luggage compartment cover	●	●
Outside temperature gauge	●	●
Reading lights – front and rear	●	●
Service indicator ASSYST	●	●



Item	SE Executive	AMG Line
Interior (continued)		
Split folding rear seats – 1/3:2/3, with manual back adjustment	●	●
Sports pedals – stainless steel with rubber studs	–	●
Sports pedals – stainless steel with rubber studs	–	●
Sports seats with ARTICO leather ¹ /DINAMICA microfibre	–	●
Sun visors with illuminated vanity mirrors	●	●
THERMATIC – automatic climate control	●	●
Velour floor mats – black, with nubuck leather edging and ‘Mercedes-Benz’ brushed metal badge with matt finish	–	●

Item	SE Executive	AMG Line
Paint, Trim and Upholstery		
Metallic paint	●	●
Trim – brushed light aluminium	●	●
Upholstery – ARTICO leather ¹ with perforations in seat centre panel	●	–
Upholstery – ARTICO leather ¹ /DINAMICA microfibre	–	●



Item	SE Executive	AMG Line
Security and Safety		
Active bonnet – pedestrian safety measure	●	●
Adaptive brake lights	●	●
Airbags – driver and front passenger	●	●
Airbags – front sidebags	●	●
Airbags – windowbags	●	●
Alarm system with immobiliser and interior protection (MBSS3)	●	●
Anti-lock braking system (ABS) with Brake Assist (BAS)	●	●
ATTENTION ASSIST	●	●
Continuously analyses driver behaviour and steering movements. If patterns are recognised which characterise drowsiness, the driver is prompted to take a break, and an audible warning is sounded. At the same time COMAND Online offers to locate a rest stop		

Item	SE Executive	AMG Line
Automatic child seat recognition sensor Works in conjunction with Mercedes-Benz child seats fitted with transponder	●	●
COLLISION PREVENTION ASSIST	●	●
Downhill Speed Regulation (DSR) with switch and variable speed control	●	●
Electric parking brake	●	●
Electronic Stability Programme (ESP®) with Acceleration Skid Control (ASR)	●	●
ESP® Trailer Stability Assist	●	●
First-aid kit and warning triangle	●	●
Four-wheel Electronic Traction System (4ETS)	●	●
Headlamp Assist – automatic headlamp activation	●	●
High-level third brake light	●	●



Item	SE Executive	AMG Line
Security and Safety (continued)		
Hill-Start Assist	●	●
ISOFIX and top-tether child seat fixing points in rear (two outer seats)	●	●
Manually adjustable head restraints – front and rear	●	●
PRE-SAFE® anticipatory safety system	●	●
Remote central locking	●	●
Seat belt pre-tensioners and force limiters – front and outer rear seats	●	●
Tyre pressure monitoring system	●	●

Item	SE Executive	AMG Line
Communications and In-Car Entertainment		
Bluetooth® interface for hands-free telephony	●	●
Central controller dial to operate audio functions and telephone (when connected)	●	●
COMAND Online system with Media Interface Includes radio, single CD/DVD, 7-inch colour display, hard disk drive (HDD) navigation with 3D map display, Live Traffic Information and European map data updates free of charge for the first three years and LINGUATRONIC voice control. Internet-enabled mobile phone required for emergency call system (eCall), Mercedes-Benz apps and in-car internet access for Facebook, internet radio, sending routes from Google Maps™ to the vehicle, news and weather reports. Also includes SD memory card slot, 10GB music register and MP3 compatibility. Media Interface allows connection and control of portable media devices (e.g. MP3 player, USB storage media). Cable included for iPod® connectivity	●	●
USB port in centre armrest	●	●



> View offers



Book a > test drive > AMG test drive



> Find a Retailer



> View the Range Guide

Wheels



25

A revolution in style

Item	Notes		SE Executive	AMG Line	ML 63 AMG 4MATIC	Basic RRP excl. VAT (£)	Total RRP incl. VAT (£)
Wheels							
17" alloy wheels (4) – 10-spoke design 235/65 tyres			23R ○	-	-	95.83	115.00
19" alloy wheels (4) – 5-spoke design 255/50 tyres			R39 ●	-	-	-	-
20" AMG alloy wheels (4) – 5-spoke design 265/45 tyres			758 -	●	-	-	-
20" AMG alloy wheels (4) – 5-spoke design 265/45 tyres			778 -	-	●	-	-

● Standard ○ Optional - Not available



Item	Notes		SE Executive	AMG Line	ML 63 AMG 4MATIC	Basic RRP excl. VAT (£)	Total RRP incl. VAT (£)	
Wheels (continued)								
21" AMG alloy wheels (4) – 5-twin-spoke design 265/40 tyres	Only available with AIRMATIC air suspension (code 489) as part of the Sports package (code DP8) or the Off-Road package (code DP9)		757	-	○	-	1,245.83	1,495.00
21" AMG alloy wheels (4) – 5-twin-spoke design 295/35 tyres	Available as part of the Premium package (code DP0). See page 34 for pricing		798	-	-	○	-	-
21" AMG alloy wheels (4) – 5-twin-spoke design, painted matt black 295/35 tyres	Available as part of the Premium package (code DP0)		685	-	-	○	437.50	525.00



Exclusive package



Temperature-controlled cup holders

Once you've made your choice between the SE Executive or AMG Line, the M-Class has yet more to offer. Our range of optional equipment packages hold a wide range of features to suit individual requirements; the Exclusive package, Premium package and Premium Plus package all include features to enhance comfort and convenience.

Designed for the SE Executive and AMG Line, **the Exclusive package** blends stylish leather with a highly comfortable atmosphere on board. It features heated rear seats, THERMOTRONIC luxury automatic climate control and even temperature-controlled cup holders that keep drinks cold or warm.

Exclusive package – designed and priced as a package, including items as listed below.

SE Executive and AMG Line **Total incl. VAT £2,695.00**

Exclusive package (code DP4)

ARTICO leather¹ dashboard

Heated rear seats

Temperature-controlled cup holders

THERMOTRONIC – luxury automatic climate control

Upholstery – single-tone or two-tone leather

¹Man-made leather



> View offers



Book a > test drive > AMG test drive



> Find a Retailer



> View the Range Guide

Premium and Premium Plus packages



Panoramic electric sunroof



Memory package



Harman Kardon® Logic 7® surround sound system



Running boards



Reversing camera



Ambient lighting



The Premium package is all about additional convenience. It allows your M-Class to remember individual seating positions, creates open-air atmosphere with a panoramic electric sunroof, adds sporty styling with aluminium-look running boards, and makes parking that little bit easier – thanks to the reversing camera. **The Premium Plus package** offers the

same benefits as the Premium package and more: ambient lighting offers a choice of three colour settings, while the KEYLESS-GO comes with keyless entry and keyless start. The Harman Kardon® Logic 7® surround sound system with 14 high-performance speakers is also part of this package. Both packages are exclusively available for the SE Executive and AMG Line.

Item	Notes	Premium £2,595.00 ¹ (code DP0)	Premium Plus £4,195.00 ¹ (code DP1)
Memory package	Driver's seat, front passenger seat, steering column and exterior mirrors – electrically adjustable with memory	■	■
Panoramic electric sunroof	Consisting of a fixed panoramic glass rear section and an electrically operated sliding glass front section, the glass roof provides additional light and ventilation into the car	■	■
Reversing camera	Switched on automatically when reverse gear is selected. Shows the area behind vehicle with dynamic guidelines on the head unit display	■	■
Running boards	Aluminium-look running boards mounted on the side at the height of the side skirts. Slip-resistant rubber studs ensure a firm foothold. Easier to get into the front and rear	■	■
Ambient lighting	Choice of three colour settings: neutral (white), solar (amber) and polar (ice blue)	-	■
KEYLESS-GO	Including keyless entry and keyless start	-	■
Surround sound system – Harman Kardon® Logic 7® with Dolby Digital 5.1 and DTS	14 high-performance speakers and additional amplifier with a total output of 830 watts	-	■

[View offers](#)[Book a test drive](#) [AMG test drive](#)[Find a Retailer](#)[View the Range Guide](#)

30

Pricing summary for Premium and Premium Plus packages

Model	Transmission	Recommended OTR price (£) ¹					
		SE Executive	SE Executive Premium	SE Executive Premium Plus	AMG Line	AMG Line Premium	AMG Line Premium Plus
ML 250 BlueTEC 4MATIC	7G-TRONIC PLUS 7-speed automatic	48,190.00	50,785.00	52,385.00	50,850.00	53,445.00	55,045.00
ML 350 BlueTEC 4MATIC	7G-TRONIC PLUS 7-speed automatic	51,340.00	53,935.00	55,535.00	54,000.00	56,595.00	58,195.00

¹Recommended on-the-road price: these prices reflect the Road Fund Licence applicable to the standard model plus £670.00 additional costs necessary to put your car on the road.

Included are a standard UK delivery charge (£540.00 incl. VAT), new vehicle registration fee (£55.00), number plates (£25.00 incl. VAT) and fuel (£50.00 incl. VAT). VAT is calculated at the standard rate of 20%



Entertainment package



Want to turn the M-Class into a mobile cinema? There's the Entertainment package. Perhaps you'd like to enhance the outstanding driving dynamics? Opt for the Sports package. Or if you want to boost the off-road credentials of the M-Class, choose the Off-Road package. On the following pages, you'll find tailor-made packages for many individual needs.

The Entertainment package turns your M-Class into a mobile cinema: it gives rear seat passengers everything they need to watch films or use a games console without disturbing the driver. It comprises a DVD player, two 8-inch TFT colour displays that attach to the backs of the electric front seat head restraints and can be used independently of one another, two sets of wireless headphones, a remote control and twin aux-in sockets.

Entertainment package – designed and priced as a package, including items as listed below.

All models

Total incl. VAT £2,495.00

Entertainment package (code DP7)

Rear seat entertainment system

TV tuner



Sports package



The Sports package takes ride comfort and safety to another level while adding a stylish touch with 21" AMG 5-twin-spoke alloy wheels. The package includes AIRMATIC air suspension with Adaptive Damping System, which adjusts damping to suit the road surface, driving style and vehicle load. It also allows the driver to switch manually between sporty and comfort-biased settings and, thanks to independent self-levelling, ensures the car's ride height is unaffected by heavy loads. AIRMATIC air suspension can also give you extra ground clearance at the touch of a button, allowing you to increase the ride height to 255 mm when tackling rough terrain. The package is available for the AMG Line only.

Sports package – designed and priced as a package, including items as listed below.

AMG Line only

Total incl. VAT £1,995.000

Sports package (code DP8)

21" AMG 5-twin-spoke alloy wheels (code 757)

AIRMATIC air suspension



Off-Road package

The **Off-Road package** combines a host of features that come in handy when taking your M-Class off the beaten track. It includes six driving modes to choose from: 'Auto' (standard mode), 'Off-Road 1' (for sandy or less challenging terrain), 'Off-Road 2' (for rougher terrain), 'Sport', 'Snow' and 'Towing'. These pre-programmed modes alter the Electronic Stability Programme (ESP®), Electronic Traction System (4ETS) and Acceleration Skid Control (ASR) parameters, as well as the engine management, transmission and steering systems, and also adjust the air suspension, damping levels and ground clearance as required. In 'Off-Road 2' mode the wading depth is increased to a total of 600 mm, and the AIRMATIC air

suspension allows for a maximum ground clearance of 266 mm. 'Sport' mode reduces the standard ride height by 15 mm to 161 mm at high speeds to ensure optimum agility and stability. A range of convenient systems including a 360° camera and the EASY-PACK load-securing kit are also included in the package.

Off-Road package – designed and priced as a package, including items as listed below.

SE Executive and AMG Line

Total incl. VAT £3,995.00

Off-Road package (code DP9)

- 100% differential lock on centre differential
- 360° camera
- AIRMATIC air suspension
- EASY-PACK load-securing kit
- Front and rear axles with adapted 4ETS
- Guard under engine with reinforced underbody panelling
- Low-range gearbox
- Manual mode for automatic transmission
- Rotary switch with six driving modes
- Special off-road algorithm for ABS, 4ETS and ESP®
- Three additional selectable off-road ride heights



Screen view for off-road settings



Driving Assistance package



Active Blind Spot Assist

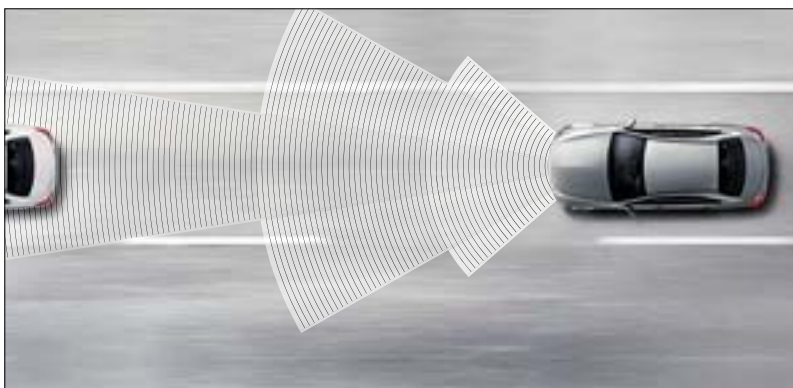

DISTRONIC PLUS

The Driving Assistance package contains a range of highly intelligent features to help you stay safe on the road – by making the drive more effortless, by warning of danger, and by taking steps to protect you in an emergency. It includes Active Blind Spot Assist, DISTRONIC PLUS, Active Lane Keeping Assist, BAS PLUS and PRE-SAFE® Brake.

Driving Assistance package – designed and priced as a package, including items as listed below.

All models

Total incl. VAT £2,350.00

Driving Assistance package (code 23P)

Active Blind Spot Assist displays a red triangle in the exterior mirrors. When a road user is detected in the blind spot, the red triangle flashes and an audible warning sounds if the driver operates the indicators. Includes course-correcting braking intervention

Active Lane Keeping Assist detects signs of inadvertent drifting out of lane and warns the driver by vibrating the steering wheel and, if necessary, triggers one-sided braking intervention

BAS PLUS can lower the risk of rear-end collisions and support the driver during emergency braking by providing additional brake pressure

DISTRONIC PLUS helps the driver to maintain a safe distance to the vehicle in front and so relieves the strain on the driver, especially on long journeys or in a traffic jam

PRE-SAFE® Brake warns the driver if it detects that a rear-end collision is imminent and, if there is no reaction, can take autonomous action to reduce the speed – even to the extent of full brake application



Optional equipment

Item	Notes	SE Executive AMG Line			Basic RRP excl. VAT (£)	Total RRP incl. VAT (£)
Suspension and Exterior						
360° camera	Only in conjunction with Premium package (code DP0) or Premium Plus package (code DP1)	501	<input type="radio"/>	<input type="radio"/>	229.17	275.00
Active Curve system With active suspension stabilisers. Enhances ride comfort, agility and safety at high speed, when cornering and when driving off-road	Only in conjunction with Sports package (code DP8) or Off-Road package (code DP9) on ML 350 BlueTEC 4MATIC	468	<input type="radio"/>	<input type="radio"/>	2,700.00	3,240.00
Adaptive Highbeam Assist The system uses a camera on the inside of windscreen to automatically adjust the beam to the traffic conditions for optimum illumination without dazzling oncoming traffic		608	<input type="radio"/>	<input type="radio"/>	87.50	105.00
Tow bar, manually folding with electric release	When ordering this option, please discuss with your Retailer any specific towing requirements	550	<input type="radio"/>	<input type="radio"/>	791.67	950.00
Paint, Trim and Upholstery						
Metallic paint – designo diamond white		799	<input type="radio"/>	<input type="radio"/>	679.17	815.00
Roof lining in designo black fabric	Not in conjunction with almond beige upholsteries (code 105 or 205)	990	<input type="radio"/>	<input type="radio"/>	308.33	370.00
Trim – black poplar wood, gloss		729	<input type="radio"/>	<input type="radio"/>	316.67	380.00
Trim – brown burr walnut wood, gloss		731	<input type="radio"/>	<input type="radio"/>	316.67	380.00
Trim – brown open-pore ash wood		H09	<input type="radio"/>	<input type="radio"/>	316.67	380.00
Upholstery – single-tone leather	When choosing optional leather upholstery for the AMG Line, the interior differs from the standard specification AMG Line interior. The 4-spoke steering wheel, seats and door centre panels are in a different design; the sports pedals are replaced and the ‘Mercedes-Benz’-badged floor mats removed	'	<input type="radio"/>	<input type="radio"/>	958.33	1,150.00
Upholstery – two-tone leather		'	<input type="radio"/>	<input type="radio"/>	958.33	1,150.00



Item	Notes		SE Executive	AMG Line	Basic RRP excl. VAT (£)	Total RRP incl. VAT (£)
Comfort						
Front seats – comfort-ventilated	Only in conjunction with leather upholstery. Leather on front seats is perforated when this option is chosen	401	<input type="radio"/>	<input type="radio"/>	625.00	750.00
Multi-contour front seats Inflatable air chambers allow the front seats to be individually adjusted – from seat cushion depth via the side bolsters to the position and curvature of the backrest. A lumbar adjustment gives added support to the spine. The massage function with seven zones and two selectable intensity settings helps to avoid muscle tension. Added comfort and safety is offered by the luxury head restraints	Not in conjunction with black ARTICO leather ¹ /DINAMICA microfibre	399	<input type="radio"/>	<input type="radio"/>	958.33	1,150.00
Panoramic glass sunroof Consists of a fixed panoramic glass sunroof above the rear seat row and an electrically operated sliding glass front section		413	<input type="radio"/>	<input type="radio"/>	1,529.17	1,835.00
Security and Safety						
Driving Assistance package Active Blind Spot Assist, Active Lane Keeping Assist and DISTRONIC PLUS with PRE-SAFE [®] Brake	For detailed information, please refer to page 24	23P	<input type="radio"/>	<input type="radio"/>	1,958.33	2,350.00
Night View Assist Plus Aids recognition of pedestrians or larger animals at night: they are clearly shown on the multi-function display		610	<input type="radio"/>	<input type="radio"/>	1,087.50	1,305.00



> View offers



Book a > test drive > AMG test drive



> Find a Retailer



> View the Range Guide

Optional equipment

37

Item	Notes	SE Executive	AMG Line	Basic RRP excl. VAT (£)	Total RRP incl. VAT (£)	
Communications and In-Car Entertainment						
DAB digital radio tuner		537	<input type="radio"/>	<input type="radio"/>	358.33	430.00
Service Package						
<p>Service Care</p> <p>Service Care allows you to spread the cost of servicing your new car in the Mercedes-Benz Retailer network. Taking out a Service Care plan ensures your servicing needs are taken care of by fully trained Mercedes-Benz Technicians with the added benefit of a Mercedes-Benz service history</p>	<p>Price is based on a monthly rate. Example given is for two services taken over 24 months, three services over 36 months or four services over 48 months. Further payment options are available. New Service Care prices apply only to vehicles up to 12 months old prior to first service</p>		<input type="radio"/>	<input type="radio"/>	25.00	30.00



> View offers



Book a > test drive > AMG test drive



> Find a Retailer



> View the Range Guide

38

ML 63 AMG 4MATIC





An exhilarating drive and a captivating sight, the ML 63 AMG 4MATIC combines personality, performance and outstanding versatility. Its muscular exterior boasts exclusive AMG styling enhancements, including 20 mm wider front wings with 'V8 BITURBO' badges, a gloss black three-bar grille and dark-tinted headlamps, as well as an AMG front apron with LED daytime running lamps and a matt chrome front apron trim. At the rear, there's a model-specific AMG apron with chrome apron trim and sporty chromed twin tailpipes left and right.

Under the skin, the ML 63 AMG 4MATIC boasts a biturbo AMG V8 that, together with the AMG SPEEDSHIFT PLUS 7-speed sports transmission, delivers sports-car performance combined with remarkable levels of efficiency. Climb aboard and the ML 63 AMG 4MATIC welcomes you with illuminated stainless steel sill panels featuring 'AMG' lettering. Once inside, you and your front seat passenger will find yourselves in the comfortable embrace of AMG sports seats and surrounded by sumptuous leather upholstery.

Exterior

- 20" AMG 5-twin-spoke alloy wheels
- AMG bodystyling with exclusive ML 63 AMG 4MATIC front and rear aprons, side skirts
- AMG door sill panels in brushed stainless steel
- AMG LED daytime running lamps
- AMG sports exhaust system with two chromed twin tailpipes
- Panoramic electric sunroof with interior sun blind

Interior

- AMG brushed stainless steel sports pedals with rubber studs
- AMG instrument cluster with animated start-up sequence and AMG main menu

- AMG performance steering wheel – 4-spoke multi-function, trimmed in nappa leather
- Front seats – full electric adjustment and four-way electric lumbar adjustment
- Split folding rear seats – 1/3:2/3, with manual back adjustment
- THERMOTRONIC – luxury automatic climate control

Trim and Upholstery

Brushed light aluminium



Leather





AMG standard equipment

Item

Transmission and Suspension

AMG SPEEDSHIFT PLUS 7G-TRONIC 7-speed automatic transmission with SPEEDTRONIC cruise control

AMG sports suspension

Active Curve system

Enhances ride comfort, agility and safety at high speed, when cornering and when driving off-road

AIRMATIC air suspension

ECO start/stop function

Permanent four-wheel drive

Steering

AMG performance 4-spoke multi-function steering wheel, trimmed in nappa leather with perforated grip areas, flattened bottom section and silver-coloured gearshift paddles

Direct Steering

Steering column – manually adjustable for height and reach

Item

Exterior

AMG bodystyling with exclusive ML 63 AMG 4MATIC front and rear aprons, side skirts

AMG door sill panels in brushed stainless steel

AMG LED daytime running lamps

AMG sports exhaust system with two chromed twin tailpipes

Active Parking Assist with PARKTRONIC

PARKTRONIC monitors the front and rear end whilst the driver is manoeuvring the vehicle and gives a warning if the risk of a collision is detected. Active Parking Assist makes it easier to find a parking space and also automatically steers the vehicle into parking spaces

Ambient lighting on underside of door mirrors

Door mirrors – electrically operated, heated, automatically dimming and folding

EASY-PACK powered tailgate – opens and closes automatically

Front and rear apron trims, chrome style

Headlamps – Intelligent Light System

Bi-xenon headlamps, Active Light System, automatic headlamp range adjustment, cornering light function, headlamp wash and Adaptive Highbeam Assist



> View offers



Book a > test drive > AMG test drive



> Find a Retailer



> View the Range Guide

Item

Exterior (continued)

Heated windscreen wash system

LED rear lamps

Panoramic electric sunroof with interior sun blind

Privacy glass

Radiator grille with three chromed louvres

Rain-sensing wipers

Rear bumper with integrated reflectors

Rear screen wash/wiper

Roof rails - aluminium finish

Tinted glass - green

TIREFIT tyre-sealant kit

'V8 BITURBO' lettering on front wings

Item

Interior

Memory package

AMG brushed stainless steel sports pedals with rubber studs

AMG floor mats

AMG instrument cluster with animated start-up sequence and AMG main menu

AMG sports seats with leather upholstery

12V socket in load compartment and passenger compartment, front and rear

Automatically dimming rear-view mirror

Centre armrests - front (with storage) and rear

Cup holders - front (2) and rear (2)

Door centre panels in ARTICO leather¹

Electric windows (4)

Front seats - full electric adjustment (backrest, height and longitude) and four-way electric lumbar adjustment

¹Man-made leather

**Item****Interior (continued)**

Front seats – heated

Load-securing rings (4)

Luggage compartment cover

Outside temperature gauge

Reading lights, front and rear

Service indicator ASSYST

Split folding rear seats – 1/3:2/3, with manual back adjustment

Sun visors with illuminated vanity mirrors

THERMOTRONIC – luxury automatic climate control

Multi-zone function with separate air distribution settings for driver/front passenger and rear.

Three different climate modes: Focused, Medium and Diffuse

Paint, Trim and Upholstery

Dashboard – upper and lower sections, beltline and door panels in ARTICO leather¹ with topstitching

Paint – metallic

Trim – brushed light aluminium

Upholstery – single-tone or two-tone leather

Item**Security and Safety**

AMG high-performance braking system

Adaptive brake lights

Airbags – driver and front passenger

Airbags – front sidebags

Airbags – windowbags

Alarm system with immobiliser and interior protection (MBSS3)

Anti-lock braking system (ABS) with Brake Assist (BAS)

ATTENTION ASSIST – monitors steering behaviour and can help to alert to long journey fatigue

Automatic child seat recognition sensor

Works in conjunction with Mercedes-Benz child seats fitted with transponder

COLLISION PREVENTION ASSIST

Downhill Speed Regulation (DSR) with switch and variable speed control

Electric parking brake

Electronic Stability Programme (ESP®) with Acceleration Skid Control (ASR)

ESP® Trailer Stability Assist

First-aid kit and warning triangle

Four-wheel Electronic Traction System (4ETS)

**Item****Security and Safety (continued)**

Headlamp Assist – automatic headlamp activation

High-level third brake light

Hill-Start Assist

ISOFIX and top-tether child seat fixing points in rear (two outer seats)

Manually adjustable head restraints – front and rear

PRE-SAFE® anticipatory safety system

Remote central locking

Seat belt pre-tensioners and force limiters – front and outer rear seats

Tyre pressure monitoring system

Item**Communications and In-Car Entertainment**

Bluetooth® interface for hands-free telephony

Central controller dial to operate audio functions and telephone (when connected)

COMAND Online system with Media Interface

Includes radio, single CD/DVD, 7-inch colour display, hard disk drive (HDD) navigation with 3D map display, Live Traffic Information and European map data updates free of charge for the first three years and LINGUATRONIC voice control. Internet-enabled mobile phone required for emergency call system (eCall), Mercedes-Benz apps and in-car internet access for Facebook, internet radio, sending routes from Google Maps™ to the vehicle, news and weather reports. Also includes SD memory card slot, 10 GB music register and MP3 compatibility.

Media Interface allows connection and control of portable media devices (e.g. MP3 player, USB storage media). Cable included for iPod® connectivity

DAB digital radio tuner

Surround sound system – Harman Kardon® Logic 7® with Dolby Digital 5.1 and DTS
14 high-performance speakers and additional amplifier



> View offers



Book a > test drive > AMG test drive



> Find a Retailer



> View the Range Guide

Premium package



Reversing camera



KEYLESS-GO



21" AMG 5-twin-spoke alloy wheels



Running boards

The Premium package for the ML 63 AMG 4MATIC offers a strong combination of comfort and style: eye-catching 21" alloy wheels and aluminium-look running boards meet the handy KEYLESS-GO for keyless access and the reversing camera for effortless parking.

Premium package – designed and priced as a package, including items as listed below.

ML 63 AMG 4MATIC only **Total incl. VAT £2,195.00**

Premium package (code DP0)

21" AMG 5-twin-spoke alloy wheels, painted in titanium grey (code 798)

KEYLESS-GO

Including keyless entry and keyless start

Reversing camera

Switched on automatically when reverse gear is selected. Shows the area behind vehicle with dynamic guidelines on the head unit display

Running boards

Aluminium-look running boards mounted on the side at the height of the side skirts. Slip-resistant rubber studs ensure a firm foothold. Easier to get into the front and rear

[View offers](#)[Book a test drive](#) [AMG test drive](#)[Find a Retailer](#)[View the Range Guide](#)

Pricing summary for Premium package

Model	Transmission	Recommended OTR price (£) ¹	
		ML 63 AMG 4MATIC	ML 63 AMG 4MATIC Premium
ML 63 AMG 4MATIC	AMG SPEEDSHIFT PLUS 7G-TRONIC 7-speed automatic	87,005.00	89,200.00

¹Recommended on-the-road price: these prices reflect the Road Fund Licence applicable to the standard model plus £670.00 additional costs necessary to put your car on the road. Included are a standard UK delivery charge (£540.00 incl. VAT), new vehicle registration fee (£55.00), number plates (£25.00 incl. VAT) and fuel (£50.00 incl. VAT). VAT is calculated at the standard rate of 20%



AMG optional equipment

Item	Notes		Basic RRP excl. VAT (£)	Total RRP incl. VAT (£)
AMG Performance Studio				
AMG Driver's package Attendance at an AMG 'Power and Passion' driving event Increase in the electronically limited top speed		250	2,350.00	2,820.00
AMG Performance package AMG performance steering wheel (code 281) and red-painted brake calipers Power upgrade by 32 hp (24 kW)/60 Nm		P30	5,137.50	6,165.00
AMG carbon fibre engine cover		B14	1,275.00	1,530.00
AMG performance steering wheel in DINAMICA microfibre/nappa leather		281	350.00	420.00
Exterior				
360° camera	Only in conjunction with Premium package (code DP0)	501	229.17	275.00
Tow bar, manually folding with electric release	When ordering this option, please discuss with your Retailer any specific towing requirements	550	791.67	950.00

[View offers](#)[Book a test drive](#) [AMG test drive](#)[Find a Retailer](#)[View the Range Guide](#)

Item	Notes		Basic RRP excl. VAT (£)	Total RRP incl. VAT (£)
Paint, Trim and Upholstery				
designo Exclusive leather upholstery Armrests in doors and centre console and handrest in chosen designo leather colour Dashboard and door beltlines trimmed in black nappa leather Double sun visors (code 543) Floor mats with edging in designo black leather and designo metal badges Roof lining in black DINAMICA microfibre Seat and door centre panels in chosen designo leather colour with AMG badges in front and rear seat backrests Available in: designo marron X06 designo black X11 designo porcelain X27	Based on black leather (code 201)	1	3,787.50	4,545.00
designo black piano lacquer trim		W69	1,308.33	1,570.00



Item	Notes		Basic RRP excl. VAT (£)	Total RRP incl. VAT (£)
Paint, Trim and Upholstery (continued)				
Metallic paint – designo diamond white		799	697.17	815.00
Roof lining in designo black DINAMICA microfibre	Not in conjunction with almond beige leather upholstery (code 205). Included with designo Exclusive leather upholstery (codes X06, X11 or X27)	Y41	1,362.50	1,635.00
Roof lining in designo black fabric	Not in conjunction with almond beige leather upholstery (code 205)	Y90	308.33	370.00
Trim – anthracite poplar wood, gloss		729	316.67	380.00
Trim – brown burr walnut wood, gloss		731	316.67	380.00
Trim – brown open-pore ash wood		H09	316.67	380.00
Comfort				
Ambient lighting – choice of three colour settings		876	304.17	365.00
Cup holder – temperature-controlled	Not in conjunction with Premium package (code DP0)	311	183.33	220.00
Front seats – comfort-ventilated	Leather on front seats is perforated when this option is chosen	401	625.00	750.00
Multi-contour front seats Inflatable air chambers allow the front seats to be individually adjusted – from seat cushion depth via the side bolsters to the position and curvature of the backrest. A lumbar adjustment gives added support to the spine. The massage function with seven zones and two selectable intensity settings helps to avoid muscle tension		399	958.33	1,150.00
Rear seats – heated		872	295.83	355.00



Item	Notes		Basic RRP excl. VAT (£)	Total RRP incl. VAT (£)
Security and Safety				
Driving Assistance package Active Blind Spot Assist, Active Lane Keeping Assist and DISTRONIC PLUS with PRE-SAFE® Brake	For detailed information, please refer to page 24	23P	1,958.33	2,350.00
Night View Assist Plus Aids recognition of pedestrians or larger animals at night: they are clearly shown on the multi-function display		610	1,087.50	1,305.00
Communications and In-Car Entertainment				
Surround sound system – Bang & Olufsen BeoSound AMG 14 high-performance speakers with twin illuminated tweeter lenses	Not in conjunction with Harman Kardon® Logic 7® surround sound system	811	3,612.50	4,335.00
Service Package				
Service Care Service Care allows you to spread the cost of servicing your new car in the Mercedes-Benz Retailer network. Taking out a Service Care plan ensures your servicing needs are taken care of by fully trained Mercedes-Benz Technicians with the added benefit of a Mercedes-Benz service history	Price is based on a monthly rate. Example given is for two services taken over 24 months, three services over 36 months or four services over 48 months. Further payment options are available. New Service Care prices apply only to vehicles up to 12 months old prior to first service	1	35.00	42.00



Genuine Accessories

We've developed a range of Accessories you can add to help personalise and enhance your choice of the M-Class. Whether sporty or elegant, the design is perfectly adapted to your Mercedes-Benz. Your local Mercedes-Benz Retailer can advise on fitting costs of Accessories, where applicable. Further information on our selection of Genuine Accessories can be found on the Mercedes-Benz UK website.

01 | Stowage crate

A secure hold for items which are prone to tip over or slide around, e.g. shopping bags. Adjustable partitioning elements allow crate to be divided into max. 4 sections. Optimum functionality only in conjunction with shallow boot tub.

Basic RRP £70.83 (excl. VAT) **Total RRP £85.00 (incl. VAT)**

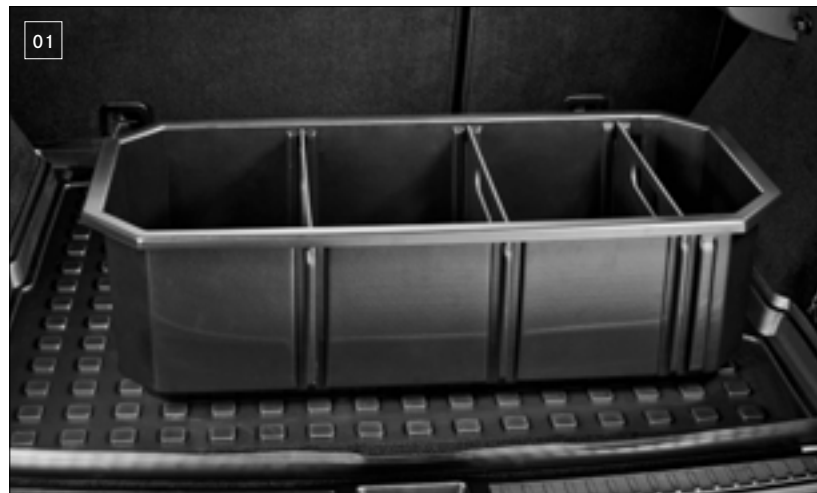

02 | Deep boot tub

Deep edge all round. Made from flexible, impact-resistant plastic. Suitable for transporting shopping. Shallow boot tub also available.

Basic RRP £158.33 (excl. VAT) **Total RRP £190.00 (incl. VAT)**





03 | Concertina load sill protector

Protects the rear of the car from scratches when you're loading the vehicle and prevents dirt from the car from getting onto your clothes. Practical design – can be connected to shallow boot tub.

Basic RRP £32.50 (excl. VAT) **Total RRP £39.00 (incl. VAT)**



04 | Floor mat trays

Robust, washable synthetic material, designed for heavy use. Covers the entire footwell. The raised edges and structured surface help keep the floor clean and dry. With distinctive 'Mercedes-Benz' lettering.

Basic RRP £129.17 (excl. VAT) **Total RRP £155.00 (incl. VAT)**



05 | Carrier bars for roof rails

Quick-fastening carrier bars for roof rails – no tools required. Multifunctional basis for all Mercedes-Benz transport and leisure accessories such as roof boxes, bicycle racks and ski racks. Locking plastic caps help prevent theft.

Basic RRP £170.83 (excl. VAT) **Total RRP £205.00 (incl. VAT)**



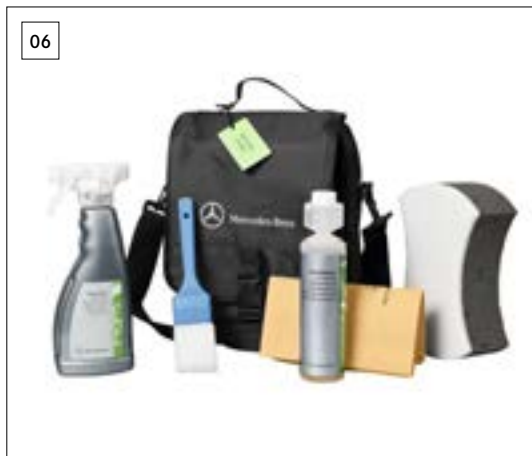

06 | Exterior Car Care Kit

The Mercedes-Benz Exterior Car Care Kit is a four-piece collection to keep the exterior of your car looking like it's come straight from the showroom. The bag contains car shampoo, wheel cleaner, sponge and polishing cloth.

Basic RRP £20.83 (excl. VAT) **Total RRP £25.00 (incl. VAT)**



07 | Interior Car Care Kit

The Mercedes-Benz Interior Car Care Kit is a four-piece collection enabling you to maintain the spotless showroom finish inside your car. The bag contains cabin care spray, interior glass cleaner, interior glass sponge and car cloth.

Basic RRP £20.83 (excl. VAT) **Total RRP £25.00 (incl. VAT)**



08 | Coat hanger, on head restraint, chrome/black metal

It's easy to arrive looking smart: the sturdy coat hanger allows you to hang up items of clothing on board. Rounded ends protect the fabric. Easy to secure in place behind the head restraint and to remove.

Basic RRP £28.33 (excl. VAT) **Total RRP £34.00 (incl. VAT)**



09 | DUO Plus child seat, with ISOFIX and automatic child seat recognition

Optimum safety for children between the ages of around 8 months and 4 years (9 to 18 kg). Fitted as standard with top tether, an additional belt for securing the head section, a height-adjustable harness, ventilation channels and ISOFIX attachment points. With automatic child seat recognition. Adjustable tilt. Also available for ages 0+ (1 to 13 kg) and 3.5 to 12 years (15 to 36 kg).

Basic RRP £428.33 (excl. VAT) **Total RRP £514.00 (incl. VAT)**

10 | Mercedes-Benz roof box, 450 litres

Multi-purpose box. Compact length, impressive amount of space. Capacity approx. 400 litres. Opens on both sides. Single lock system. Gas-filled struts for easy opening and closing of lid. Maximum load capacity 75 kg. Available in silver or metallic black.

Basic RRP £387.50 (excl. VAT) **Total RRP £465.00 (incl. VAT)**





Colours and materials

Metallic paints

Standard



151 cinnabar red



775 iridium silver

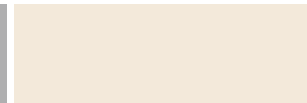

799 designo diamond white¹

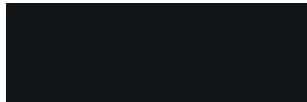

197 obsidian black



792 palladium silver



890 cavansite blue



755 tenorite grey

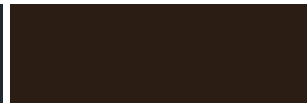

796 citrine brown



988 diamond silver

Non-metallic paint

No-cost option

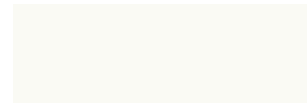

149 polar white

¹Additional-cost option Please note that, owing to limitations of the printing process, paint colours may differ from those shown



ARTICO leather¹

Standard on SE Executive



101 black



105 almond beige



108 alpaca grey

ARTICO¹/DINAMICA microfibre

Standard on AMG Line



601 black

Single-tone leather

Optional; std on ML 63 AMG 4MATIC

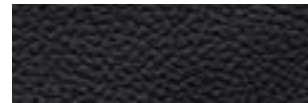

201 black²



205 almond beige²



208 alpaca grey²

Two-tone leather

Optional; std on ML 63 AMG 4MATIC

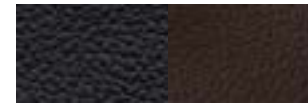

254 black/tobacco brown²

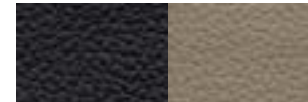

255 black/almond beige²

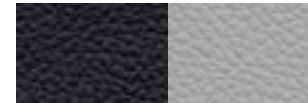

258 black/alpaca grey²

Trim



739 brushed light aluminium



729 black poplar wood^{3,4}



731 brown burr walnut wood^{3,4}



H09 brown open-pore ash wood³

¹Man-made leather ²When choosing optional leather upholstery for the AMG Line, the interior differs from the standard specification AMG Line interior. The four-spoke steering wheel, seats and door centre panels are in a different design; the sports pedals are replaced and the 'Mercedes-Benz'-badged floor mats removed ³Optional ⁴Gloss finish



Trim and upholstery combinations

	ARTICO leather ¹ / DINAMICA microfibre		ARTICO man-made leather [*] /single-tone leather [†]		Two-tone leather		
	Standard on AMG Line		*Standard on SE Executive. [†] Optional; standard on ML 63 AMG 4MATIC		Optional; standard on ML 63 AMG 4MATIC		
	black (601)	black (101/201)	almond beige (105/205)	alpaca grey (108/208)	black/ tobacco brown (254)	black/ almond beige (255)	black/ alpaca grey (258)
Dashboard							
Steering wheel	black	black	mocha brown	dark basalt grey	black	black	black
Upper dashboard trim	black	black	mocha brown	dark basalt grey	black	black	black
Lower dashboard trim	black	black	almond beige	alpaca grey	black	black	black
Seats							
Seat cushion centre section	black	black	almond beige	alpaca grey	tobacco brown	almond beige	alpaca grey
Side bolster trim	black	black	almond beige	alpaca grey	marron	almond beige	alpaca grey
Head restraint	black	black	almond beige	alpaca grey	marron	almond beige	alpaca grey
Seat belt	black	black	almond beige	alpaca grey	black	black	black
Doors							
Beltline door trim	black	black	almond beige	alpaca grey	black	black	black
Centreline door trim	black	black	almond beige	alpaca grey	marron	almond beige	alpaca grey
Lower door trim	black	black	almond beige	alpaca grey	black	black	black
Roof lining	alpaca grey	alpaca grey	almond beige	alpaca grey	black	black	black
Floor covering							
Front and rear	black	black	almond beige	dark basalt grey	black	black	black
Boot	black	black	almond beige	dark basalt grey	black	black	black

¹Man-made leather



Combination options

	151 cinnabar red	197 obsidian black	755 tenorite grey	775 iridium silver	792 palladium silver	796 citrine brown	799 designo diamond white	890 cavansite blue	988 diamond silver	149 polar white
Metallic paints Standard										
ARTICO leather¹/DINAMICA microfibre										
black	●	●	●	●	●	●	●	●	●	●
ARTICO leather¹/single-tone leather										
black	●	●	●	●	●	●	●	●	●	●
almond beige	●	●	○	○	●	●	●	○	○	●
alpaca grey	●	●	●	●	●	○	●	●	●	●
Two-tone leather										
black/tobacco brown	○	●	●	●	●	●	●	●	●	●
black/almond beige	●	●	●	●	●	●	●	●	●	●
black/alpaca grey	●	●	●	●	●	○	●	●	●	●

● Recommended ○ Possible Please note that, owing to limitations of the printing process, paint colours may differ from those shown



Technical data

Model	Diesel engines		Petrol engine	
	ML 250 BlueTEC 4MATIC	ML 350 BlueTEC 4MATIC	ML 63 AMG 4MATIC	
Engine				
Total displacement	cc	2,143	2,987	5,461
Arrangement/cylinders/valves		in-line/4/16	V/6/24	V/8/32
Power ¹	hp (kW) at rpm	204 (150)/4,200	258 (190)/3,600	525 (386)/5,250-5,750 [557 (410)/5,250-5750 ²]
Torque ¹	Nm at rpm	500/1,600-1,800	620/1,600-2,400	700/1,750-5,000 [760 2,000-5000 ²]
Transmission				
7G-TRONIC PLUS 7-speed auto.		●	●	-
AMG SPEEDSHIFT PLUS 7G-TRONIC 7-speed auto.		-	-	●
Performance				
Acceleration 0-62 mph	sec	9.0	7.4	4.8
Top speed	mph	130	139	155 ³ [174 ⁴]



Model	Diesel engines		Petrol engine
	ML 250 BlueTEC 4MATIC	ML 350 BlueTEC 4MATIC	ML 63 AMG 4MATIC
Weights and capacities	auto.	auto.	auto.
Kerb weight	kg 2,150	2,175	2,345
Perm. Gross Vehicle Weight	kg 2,950	2,950	3,050
Towing capacity - unbraked	750	750	750
braked	kg 2,950	3,500	3,050
Boot capacity	l		
max. behind 1st row of seats (loaded to roofline)	2,010	2,010	2,010
max. behind 2nd row of seats (loaded to top of backrest)	690	690	690
Fuel tank capacity/of which reserve	l 93/12	93/12	93/14
Turning circle (wall to wall)	m 11.8	11.8	11.8
Wading depth - standard	500	500	580
with Off-Road package range	mm 500-600	500-600	-
Fuel consumption^{4,5}	mpg auto.	auto.	auto.
Urban	39.8	34.9	18.0
Extra-urban ⁶	49.6	42.2	29.4
Combined	45.6	39.2	23.9



Model	Diesel engines		Petrol engine
	ML 250 BlueTEC 4MATIC	ML 350 BlueTEC 4MATIC	ML 63 AMG 4MATIC
CO₂ emissions⁶	g/km	auto.	auto.
Emissions standard	EU6	EU6	EU6
17" alloy wheels (code 25R)	154	179	-
19" alloy wheels (code R39)	163	189	-
20" AMG alloy wheels (code 758)	163	189	-
20" AMG alloy wheels (code 778)	-	-	276
21" AMG alloy wheels (code 757)	159	187	-
21" AMG alloy wheels (code 798)	-	-	276
21" AMG alloy wheels (code 685)	-	-	276

Insurance

Group rating	40-41	44-45	50A
--------------	-------	-------	-----

Insurance ratings may vary depending on model line and specification. Please refer to <http://www.thatcham.org/abigrouprating/> for further details

¹Figures according to Directive 80/1269/EEC in the currently applicable version ²In conjunction with AMG Performance package ³Electronically limited ⁴In conjunction with AMG Driver's package (code 250)

⁵All figures are based on a standard specification with the smallest tyre size ⁶The choice of wheels and transmission may affect CO₂ emissions and corresponding Road Fund Licence

⁷EUDC: extra-urban driving cycle. Testing procedures adhere to EU Directive 93/116

The figures on pages 58-61 are correct at time of going to print. Please refer to the government website for latest data - <http://www.dft.gov.uk/vca>

All measurements in millimetres. The dimensions shown are mean values and apply to standard-specification, unladen vehicles



> View offers



Book a > test drive > AMG test drive



> Find a Retailer



> View the Range Guide

Technical data

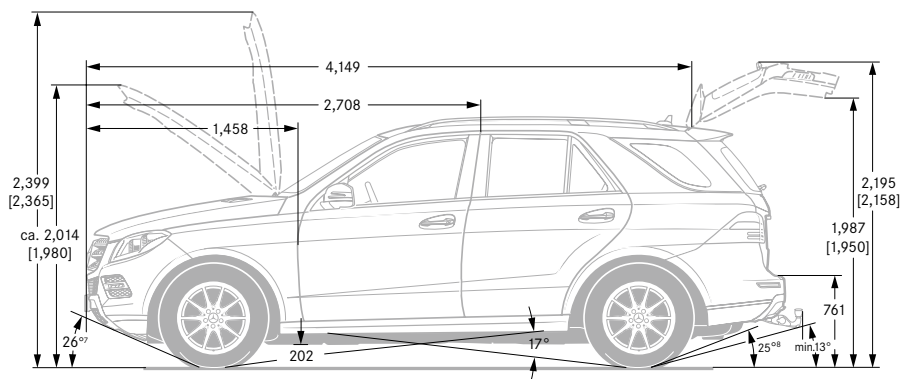
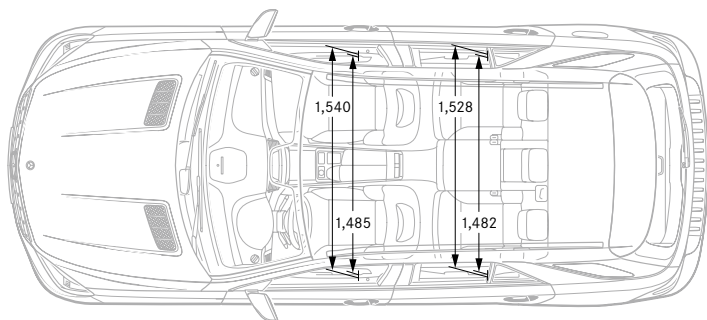
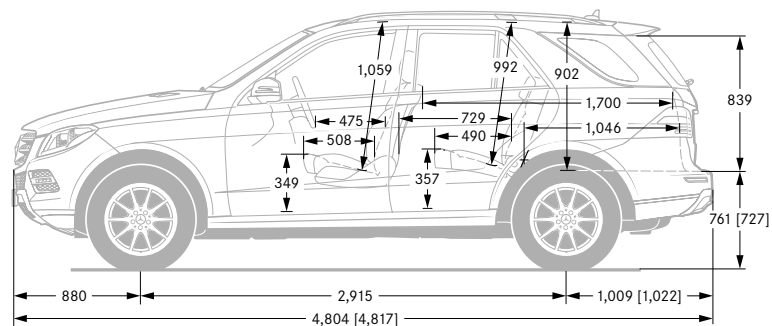
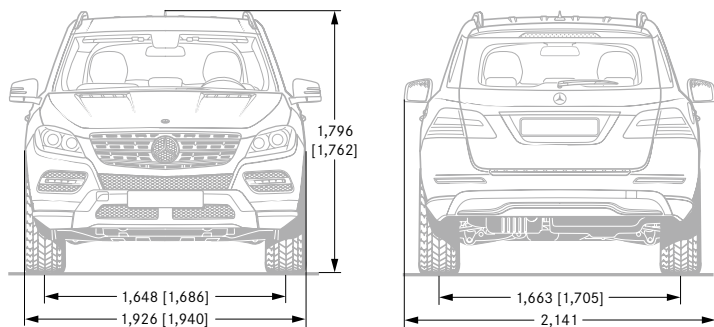

Figures in square brackets relate to ML 63 AMG 4MATIC

⁷Approach angle: with AIRMATIC Package 23°-30° range; with On- & Off-Road package 23°-31° range; AMG models 19°-23° range

⁸Departure angle: with AIRMATIC Package 23°-28° range; with On- & Off-Road package 23°-29° range; AMG models 21°-24° range



Road Fund Licence



All road vehicle registrations are subject to Vehicle Excise Duty (Road Fund Licence), which varies in accordance with the vehicle's CO₂ emissions. A first year rate of Vehicle Excise Duty applies to new cars on their first year of registration. For the second and subsequent years a standard rate for each taxation band will apply.¹ The table below shows the bands (A–M) created by the DVLA and the corresponding Road Fund Licence. CO₂ emissions are listed in the technical data on page 60, and the relevant Excise Duty is reflected in the on-the-road prices on page 11.

Band	CO ₂ emissions	First year rate (£)	Standard rate (£)
A	up to 100 g/km	0.00	0.00
B	101 to 110 g/km	0.00	20.00
C	111 to 120 g/km	0.00	30.00
D	121 to 130 g/km	0.00	110.00
E	131 to 140 g/km	130.00	130.00
F	141 to 150 g/km	145.00	145.00
G	151 to 165 g/km	180.00	180.00
H	166 to 175 g/km	295.00	205.00
I	176 to 185 g/km	350.00	225.00
J	186 to 200 g/km	490.00	265.00
K	201 to 225 g/km	640.00	290.00
L	226 to 255 g/km	870.00	490.00
M	over 255 g/km	1,100.00	505.00

¹For further information on vehicle taxation please refer to <https://www.gov.uk/calculate-vehicle-tax-rates>

Services and insurance

Mercedes-Benz Service Care

We believe that servicing costs should be as flexible and affordable as possible for your M-Class, which is why we offer Service Care, an easy way to budget for all your servicing costs. It spreads your bills into manageable payments based on whether you have a new or used Mercedes-Benz.

With Service Care we guarantee the price of parts and labour for up to four services and safeguard against any further inflation. It also covers the cost of any additional items including brake fluid, spark plugs, air filters, fuel filters and screen wash.

You can choose either to add your servicing costs into your monthly spend or pay the full amount in a one-off payment, giving you peace of mind that they are taken care of for the period of the plan.

To receive a personalised Service Care plan recommendation visit the Service Care Calculator at www.mercedes-benz.co.uk/servicecare

Warranty and breakdown cover

Every Mercedes-Benz comes with a three-year unlimited mileage warranty against manufacturing or material defects¹ and up to 30 years warranty against perforation due to corrosion from the inside out.² What's more, it's also covered by Mercedes-Benz Roadside Assistance – a unique package comprising up to 30 years pan-European breakdown assistance.²

Insurance

Since our name is synonymous with reliability, who better to trust with your motor insurance? Mercedes-Benz Insurance provides a motor insurance policy specifically designed to give you the cover you would expect from Mercedes-Benz. For a motor insurance quotation, call **0345 600 2180**.*



Mercedes-Benz Finance

Why should you finance with Mercedes-Benz?

At Mercedes-Benz we believe a great driving experience should be matched by an equally great ownership experience. That is why we put just as much thought, time and effort into designing our finance options, our service plans and our insurance cover as we do into our vehicles.

We are not in the business of simply providing a loan to fund the purchase of your dream vehicle. We look on it as a journey that we take with you, from the moment you choose your new Mercedes-Benz, to helping you in choosing your next one.

If you would like to find out more about any of our current offers, simply call into your local Mercedes-Benz Retailer where one of our Business Managers will be more than happy to talk you through anything you need to know.

Helping you find the right solution.

You should find our finance packages are more convenient than a traditional personal loan because:

- Funds are immediately available – no waiting for cheques or loans to clear.
- There is no security required – either against your home or other assets.
- We have clear and transparent rates – the APR we quote is the APR you get.
- We have friendly Business Managers – experts in vehicle finance who can talk you through all of your plans in detail.

One of our most popular finance products is Mercedes-Benz Agility (our Personal Contract Purchase product). We also offer Contract Hire, Operating Lease and Hire Purchase solutions. If you would like to find out more about these speak to your Retailer or visit www.mercedes-benz.co.uk/fandi.

Mercedes-Benz Agility (our PCP product).

At the start of an Agility agreement, you put down a deposit and decide the term of your agreement and your annual mileage. You will be advised of the Guaranteed Future Value, which offers you the reassurance of knowing exactly what you will need to pay to own the vehicle outright in the future (this is known as the Optional Purchase Payment).

Throughout your agreement you simply pay your agreed monthly payments and when the agreement comes to an end you either purchase, hand back or part-exchange your vehicle.





Agility features:

- Fixed regular payments mean you can easily budget.
- Payments are based only on a proportion of the vehicle's value, keeping your monthly payments lower.
- Our Guaranteed Future Value avoids the risk of unplanned depreciation of your vehicle.
- You defer your ownership decision until the end of the agreement.

At the end of your agreement you have three options to choose from.

Option 1: Purchase your Mercedes-Benz.

Purchase your Mercedes-Benz by paying the Optional Purchase Payment and Purchase Activation Fee.¹ This will complete the purchase of your Mercedes-Benz, leaving you free to simply enjoy your vehicle.

Option 2: Hand back your Mercedes-Benz.

If you decide to return your vehicle to us, it must be in line with our Vehicle Return Standards,* as vehicle condition, excess mileage and other charges may be payable.

Option 3: Part-Exchange for a new vehicle.

Purchase your Mercedes-Benz by paying the Optional Purchase Payment and Purchase Activation Fee.¹ This will complete the purchase of your Mercedes-Benz, leaving you free to part-exchange for a new vehicle.

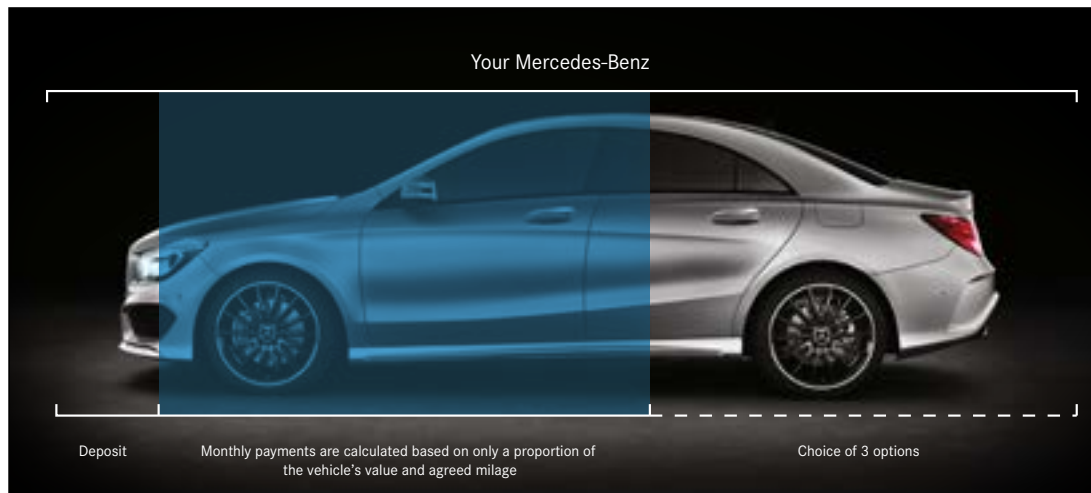

¹Please note the 'Purchase Activation Fee' of £10 will be debited from your account *To find out more information about our Vehicle Return Standards please visit <http://mercedes-benz.co.uk/vrs>



> View offers



Book a > test drive > AMG test drive



> Find a Retailer



> View the Range Guide

Follow us on the following social media channels:



<https://www.facebook.com/MercedesBenzUk>



<https://twitter.com/mercedesbenzUK>



<https://www.youtube.com/mercedesbenzUK>



<https://instagram.com/mercedesbenzUK>

Effective from 1 April 2015. Information correct at time of going to print.

Prices and specifications are subject to change without prior notice.

MBW166PL/0415

Mercedes-Benz UK Ltd, Tongwell, Milton Keynes, MK15 8BA www.mercedes-benz.co.uk



Mixed Sources

Product group from well-managed forests, controlled sources and recycled wood or fibre
www.fsc.org Cert no. SGS-COC-004556
©1996 Forest Stewardship Council

