



> View offers



> Book a test drive



> Find a Retailer



> View the Range Guide

B-Class

Electric Drive



now electric!

Effective from 1 March 2017 Production.

Mercedes-Benz





> View offers



> Book a test drive



> Find a Retailer



> View the Range Guide

Contents

| | | | | | |
|---|----|----------------------------|----|-------------------------|----|
| Model prices | 7 | Wheels | 21 | Technical data | 36 |
| Finance offers | 8 | Driving Assistance package | 22 | Road Fund Licence | 38 |
| Sport and Electric Art | 10 | Energy Assist package | 23 | Services and insurance | 39 |
| Executive equipment line | 14 | Exclusive package | 24 | Mercedes me | 40 |
| Premium equipment line | 15 | Optional equipment | 25 | Mercedes-Benz Finance | 42 |
| Pricing summary for model and equipment lines | 16 | Genuine Accessories | 28 | Chargemaster Homecharge | 44 |
| Standard equipment | 17 | Colours and materials | 32 | | |



> View offers



> Book a test drive



> Find a Retailer



> View the Range Guide

The hard facts to melt your heart

At Mercedes-Benz we appreciate the importance of detail. Over the following pages you'll find model prices and a breakdown of standard and optional equipment, as well as details of the comprehensive services and benefits that are available to every Mercedes-Benz driver.

See Mercedes-Benz in a new light. Now is the time to get yourself behind the wheel of a B-Class Electric Drive. Choose from a number of attractive finance offers. Please see pages 8-9 for further details, or visit www.mercedes-benz.co.uk/offers

Of course, some things have to be experienced to be truly appreciated, such as the qualities that set a Mercedes-Benz apart. Which is why we'd like to invite you for a test drive at your local Mercedes-Benz Retailer. Alternatively, you can make arrangements by visiting www.mercedes-benz.co.uk/testdrive

For more information visit www.mercedes-benz.co.uk or call 0333 222 0500.



> View offers



> Book a test drive



> Find a Retailer



> View the Range Guide

4



Some of the model features, optional extras and colours shown may not be available, or may only be available in a different specification.



> View offers



> Book a test drive



> Find a Retailer



> View the Range Guide



Some of the model features, optional extras and colours shown may not be available, or may only be available in a different specification.



> View offers



> Book a test drive



> Find a Retailer



> View the Range Guide



Some of the model features, optional extras and colours shown may not be available, or may only be available in a different specification.

[View offers](#)[Book a test drive](#)[Find a Retailer](#)[View the Range Guide](#)

Model prices

| Engine | Model line | Transmission | CO ₂ | Basic RRP excl. VAT (£) | Total RRP incl. VAT (£) | Road Fund Licence (£) ¹ | Rec. OTR price (£) ² | P11D value (£) | Rec. OTR with PICG (£) ³ | BiK tax rate 2017/18 (%) |
|---|--------------|--------------|-----------------|----------------------------|----------------------------|---------------------------------------|------------------------------------|-------------------|--|-----------------------------|
| B-Class Electric Drive Asynchronous motor – lithium-ion battery, 28 kWh, 179 hp/132 kW | Sport | Single speed | 0 | 27,216.67 | 32,660.00 | 0.00 | 33,375.00 | 33,320.00 | 28,875.00 | 9 |
| | Electric Art | Single speed | 0 | 27,462.50 | 32,955.00 | 0.00 | 33,670.00 | 33,615.00 | 29,170.00 | 9 |

¹A different first year rate of Vehicle Excise Duty (Road Fund Licence) applies for new cars. Please refer to page 38 for the relevant rate for the second and subsequent years

²The recommended on-the-road price includes the Road Fund Licence applicable to the standard model plus delivery charge (£635.00 incl. VAT), new vehicle registration fee (£55.00) and number plates (£25.00 incl. VAT). VAT is calculated at the standard rate of 20%

³PICG (Plug-in car grant) is a £4,500.00 discount from the government. The amount of your grant will be automatically deducted from the price of your B-Class Electric Drive when you purchase it.

Your authorised Mercedes-Benz Retailer will complete all the paperwork for you



Mercedes-Benz Finance

Even the finance offer is beautifully put together



B250 e Sport with optional metallic paint (representative example)

Based on 10,000 miles per annum

| | |
|--|--------------|
| 36 monthly payments of ¹ | £339.00 |
| Customer deposit | £4,424.30 |
| On-the-road price | £29,470.00 |
| Retailer deposit contribution | £5,660.40 |
| Optional purchase payment ² | £9,575.00 |
| Amount of credit | £19,385.30 |
| Duration of agreement | 36 months |
| Total amount payable ³ | £31,873.70 |
| Purchase activation fee ² | £10.00 |
| APR | 5.6% |
| Fixed interest rate | 5.41% |
| Excess mileage | 12p per mile |



Example offers – 5.6% APR Representative

| | Metallic | On-the-road price | Retailer deposit contribution | Customer deposit | 36 monthly payments of ¹ |
|--------------------|----------|-------------------|-------------------------------|------------------|-------------------------------------|
| B250e Sport | ○ | £29,470.00 | £5,660.40 | £4,424.30 | £339.00 |

○ Optional equipment included in the price

Mercedes-Benz Service Care

- Mercedes-Benz trained Technicians
- Maintained by Mercedes-Benz Retailers
- Meets requirements of Mercedes-Benz Agility finance agreement

Mercedes-Benz Motor Insurance

- 24/7 UK accident recovery
- We use Mercedes-Benz GenuineParts
- To qualify for up to 10% discount online, go to www.mercedes-benz.co.uk/motorinsurance
- Alternatively, call Mercedes-Benz Motor Insurance now on **0345 600 2180**⁴ for an annual quote

We may decline to quote in some circumstances. Mercedes-Benz Motor Insurance is underwritten by Aviva Insurance Limited

Content relating to finance is promoted by Mercedes-Benz Finance. Your Retailer may offer finance on behalf of other companies.

Orders/credit approvals on B-Class Electric Drive models only, between 1 July and 30 September 2017, registered by 31 December 2017; excluding non-Electric Drive. Some combinations of features/options may not be available.

Please contact your local Mercedes-Benz Retailer for availability

¹Based on a Mercedes-Benz Agility agreement. Vehicle condition, excess mileage and other charges may be payable. Quotations available on request for alternative contract lengths and mileages.

Guarantees may be required. Credit provided, subject to status, by Mercedes-Benz Finance, MK15 8BA

²Payable if you exercise the option to purchase the car

³Includes optional purchase payment, purchase activation fee and Retailer deposit contribution (where applicable)

⁴Calls are charged at local rate and may be recorded



> View offers



> Book a test drive



> Find a Retailer



> View the Range Guide

B-Class Sport



Optional metallic paint finish and Premium equipment line shown



True to its name, the Sport's dynamic styling includes a radiator grille in iridium silver with chrome inserts and 17" multi-spoke alloy wheels in himalaya grey. A choice between black, sahara beige or crystal grey ARTICO leather¹ upholstery combined with a sail pattern dashboard trim sets the tone for the interior. The door armrests feature contrast topstitching, and the 3-spoke multi-function leather steering wheel comes with a perforated

grip area. THERMOTRONIC luxury automatic climate control with dual zone adjustment and ambient lighting also add to your sense of wellbeing. Plus, for your in-car entertainment and information, there is the 8-inch colour display and the Audio 20 CD multimedia system with pre-installation for the optional Garmin[®] MAP PILOT navigation system.

Exterior

17" multi-spoke alloy wheels painted in himalaya grey

Beltline trim strip in chrome

Exterior mirrors – body coloured with integrated LED indicators and aspherically curved mirror glass

Radiator grille with two louvres painted in iridium silver with chrome inserts

Reversing camera with dynamic guidelines on central display

Interior

Ambient lighting (single colour) with indirect illumination of interior door handles at front and rear and door trim elements

Cruise Control with Limiter

Footwell lighting in front and rear

Instrument cluster with 4.5-inch TFT colour multi-function display, silver-coloured dials and red needles

KEYLESS-GO starting function

Smartphone integration comprising Apple CarPlay™

THERMOTRONIC – luxury automatic climate control (two-zone)

Trim and Upholstery

Sail pattern



ARTICO leather¹ – black



ARTICO leather¹ – crystal grey



ARTICO leather¹ – sahara beige



¹Man-made leather



> View offers



> Book a test drive



> Find a Retailer



> View the Range Guide

B-Class Electric Art

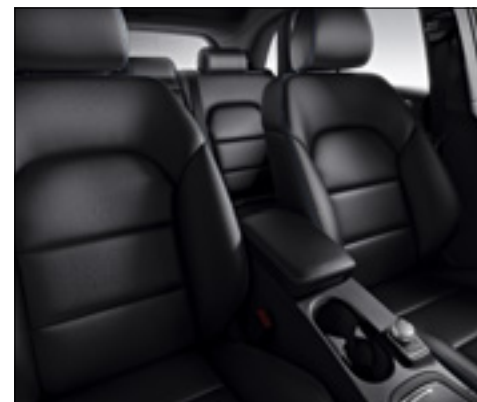

Optional Premium equipment line and privacy glass shown



You'll recognise the Electric Art model by its cirrus white or south seas blue paint finish with exterior door mirrors and a radiator grille with two louvres in contrasting paintwork. 18" multi-spoke alloy wheels in matt black are also exclusive to this model line. The stylish interior is fitted with black

ARTICO leather¹ upholstery with blue contrast stitching and sail pattern trim, combined with a black roof liner. On the velour floor mats, you'll notice 'Electric Drive' lettering and blue contrast topstitching.

Exterior

18" multi-spoke alloy wheels painted in matt black with a high-sheen finish

Beltline trim strip in chrome

Exterior mirrors in cirrus white or south seas blue (in contrast to body colour) with integrated LED indicators and aspherically curved mirror glass

Radiator grille with two louvres painted in cirrus white or south seas blue (in contrast to body colour) with chrome inserts

Reversing camera with dynamic guidelines on central display

Interior

Ambient lighting (single colour) with indirect illumination of interior door handles at front and rear and door trim elements

Footwell lighting in front and rear

Instrument cluster with 4.5-inch TFT colour multi-function display, silver-coloured dials and red needles

THERMOTRONIC – luxury automatic climate control (two-zone)

Velour floor mats with blue contrast topstitching and 'Electric Drive' lettering

Trim and Upholstery

Sail pattern



ARTICO leather¹ – black with contrast topstitching



¹Man-made leather



Executive equipment line



Parking Pilot



Heated front seats



Garmin® MAP PILOT navigation system

This equipment line is designed to add yet more comfort to your journey. It comes with Parking Pilot for effortless parking, heated front seats and the Garmin® MAP PILOT navigation system complete with 8-inch colour display.

Executive equipment line (code DP3) – designed and priced as a package, including items as listed below. **Total incl. VAT £995.00**

Executive equipment line comprises:

Parking Pilot

Parking Pilot helps find appropriate parking slots and can also automatically manoeuvre the car in and out of perpendicular and parallel parking spaces. Parking Pilot also monitors front and rear while vehicle is being manoeuvred and warns the driver if risk of collision is detected

Garmin® MAP PILOT navigation system

Operation via controller, touchpad or voice control. SD card navigation with instructions shown on the Media Display. Includes 3D views with visualisation of roads and buildings as well as junction and lane assistants, making it easy for drivers to orient themselves. Spoken instructions are emitted through vehicle's built-in speakers. Software and map can be updated online

Heated front seats



Premium equipment line



Ambient lighting



Bi-xenon headlamps



Electrically folding exterior mirrors

If you want to increase the level of comfort, this equipment line includes the same items as the Executive equipment line, plus bi-xenon headlamps for increased visibility and electrically folding exterior mirrors to assist with manoeuvring and parking in small spaces, as well as auto-dimming rear view and driver's exterior mirrors – a handy feature for dazzle-free night time driving.

Premium equipment line (code DP0) – designed and priced as a package, including items as listed below. **Total incl. VAT £1,695.00**

Premium equipment line comprises:

Parking Pilot

Parking Pilot helps find appropriate parking slots and can also automatically manoeuvre the car in and out of perpendicular and parallel parking spaces.

Parking Pilot also monitors front and rear while vehicle is being manoeuvred and warns the driver if risk of collision is detected

Ambient lighting (12-colour)

Auto-dimming rear view and driver's exterior mirrors

Bi-xenon headlamps with headlamp wash

Electrically folding exterior mirrors

Garmin® MAP PILOT navigation system

Heated front seats

[View offers](#)[Book a test drive](#)[Find a Retailer](#)[View the Range Guide](#)

Pricing summary for model and equipment lines

| Engine | Model line | Transmission | Recommended OTR price (£) ¹ | | | Recommended OTR price with PICG (£) ² | | |
|------------------------|--------------|--------------|--|-----------|-----------|--|-----------|-----------|
| | | | Base model | Executive | Premium | Base model | Executive | Premium |
| B-Class Electric Drive | Sport | Single speed | 33,375.00 | 34,370.00 | 35,070.00 | 28,875.00 | 29,870.00 | 30,570.00 |
| | Electric Art | Single speed | 33,670.00 | 34,665.00 | 35,365.00 | 29,170.00 | 30,165.00 | 30,865.00 |

¹The recommended on-the-road price includes the Road Fund Licence applicable to the standard model plus delivery charge (£635.00 incl. VAT), new vehicle registration fee (£55.00) and number plates (£25.00 incl. VAT). VAT is calculated at the standard rate of 20%

²PICG (Plug-in car grant) is a £4,500.00 discount from the government. The amount of your grant will be automatically deducted from the price of your B-Class Electric Drive when you purchase it. Your authorised Mercedes-Benz Retailer will complete all the paperwork for you



Standard equipment

| Item | Sport | Electric Art |
|---|-------|--------------|
| Transmission and Suspension | | |
| Cruise Control with Limiter | ● | ● |
| ESP® Curve Dynamic Assist | ● | ● |
| Suspension – comfort suspension | ● | ● |
| Steering | | |
| Power steering – with speed-sensitive servo assistance | ● | ● |
| Steering column manually adjustable for height and reach | ● | ● |
| Steering wheel – 3-spoke leather 12-button multi-function steering wheel with silver chrome trim and perforated grip area | ● | ● |
| Driving modes | | |
| ECO+ mode – 70kW available | ● | ● |
| ECO mode – 100kW available, with additional 32kW on kick-down | ● | ● |
| Sport mode – 132kW available, with sharper throttle response | ● | ● |
| Exterior | | |
| Beltline strips – chrome | ● | ● |
| Brakes – disc brakes all round (internally ventilated at the front) | ● | ● |

| Item | Sport | Electric Art |
|--|-------|--------------|
| Bumpers – body-coloured | ● | ● |
| Bumpers – rear bumper with short chrome trim strip | ● | ● |
| Charging cable for household socket (mode 2) – 4 m, 13 A, coiled | ● | ● |
| Charging cable for wallbox and public charging stations (mode 3) – 4 m, 16 A, non-coiled | ● | ● |
| Door handles – body-coloured | ● | ● |
| Door mirrors – exterior mirror housings in body colour with integrated LED indicators and aspherically curved mirror glass | ● | – |
| Door mirrors – exterior mirror housings in south seas blue with integrated LED indicators and aspherically curved mirror glass | – | ● |
| Lights – halogen headlamps including integral LED daytime running lamps | ● | ● |
| Lights – Headlamp Assist, automatic headlamp activation in dark conditions | ● | ● |
| Lights – high-level third brake light, LED technology | ● | ● |
| Lights – rear lights with LED fibre-optic tail lamps and LED brake lights | ● | ● |
| Radiator grille – two louvres painted in iridium silver with chrome inserts | ● | – |
| Radiator grille – two louvres painted in south seas blue with chrome inserts | – | ● |
| Wiper system – heated windscreen washer system (heated windscreen wiper nozzles and heated washer fluid hoses) | ● | ● |
| Wiper system – rear windscreen wiper with intermittent wipe and automatic activation when reversing | ● | ● |



| Item | Sport | Electric Art |
|---|-------|--------------|
| Interior | | |
| 12V socket in luggage compartment | ● | ● |
| Air conditioning – air vents with surround and cruciform nozzle in silver chrome | ● | ● |
| Air conditioning – THERMOTRONIC luxury automatic climate control (two-zone) | ● | ● |
| Armrest – armrest on centre console with stowage compartment beneath | ● | ● |
| Armrest – door armrests with contrast topstitching | ● | ● |
| Door sills – front door sill panels with 'Mercedes-Benz' lettering in front | ● | ● |
| Floor mats – velour floor mats with blue contrast topstitching and 'Electric Drive' lettering | – | ● |
| High-gloss black light switch with ring in silver chrome | ● | ● |
| Instrument cluster – 4.5-inch TFT colour multi-function display, silver-coloured dials and red needles | ● | ● |
| Instrument cluster – electronic service interval indicator ASSYST | ● | ● |
| Instrument cluster – outside temperature display | ● | ● |
| Instrument cluster – upper control panel with galvanised switches in silver chrome | ● | ● |
| Instrument cluster – warning indicators for fuel, oil, coolant and washer fluid levels and brake wear | ● | ● |
| Interior lighting – ambient lighting (single colour) with indirect illumination of interior door handles at front and rear and door trim elements | ● | ● |

| Item | Sport | Electric Art |
|---|-------|--------------|
| Interior lighting – courtesy (white) and warning (red) lights in front doors and boot lid | ● | ● |
| Interior lighting – footwell lighting in front and rear | ● | ● |
| Interior lighting – rear interior lighting with integral reading lamps and locator lighting | ● | ● |
| Interior lighting – sun visor with illuminated vanity mirror for driver and front passenger | ● | ● |
| KEYLESS-GO start function | ● | ● |
| Mirrors – rear-view mirror with additional lighting | ● | ● |
| Non-Smoker package, including 12V socket and stowage compartment in the front | ● | ● |
| Seats – front seats, height adjustable | ● | ● |
| Seats – front seats with adjustable seat cushion angle | ● | ● |
| Seats – rear seat backrests, split-folding (1/3:2/3) | ● | ● |
| Stowage – compartments in front doors | ● | ● |
| Stowage – compartment with retractable cover in centre console | ● | ● |
| Stowage – double cup holder in centre console | ● | ● |
| Stowage – load-securing rings in luggage compartment | ● | ● |
| Stowage – retractable load compartment cover | ● | ● |
| Windows – electric windows (4) | ● | ● |



| Item | Sport | Electric Art |
|--|-------|--------------|
| Paint, Trim and Upholstery | | |
| Paint – non-metallic | ● | ● |
| Roof lining – black | △ | ● |
| Roof lining – grey | △ | – |
| Trim – dashboard, sail pattern | ● | ● |
| Upholstery – ARTICO leather ¹ | ● | – |
| Upholstery – ARTICO leather ¹ in black with blue contrast topstitching | – | ● |
| Communications and In-Car Entertainment | | |
| Audio 20 CD multimedia system including pre-installation for Garmin® MAP PILOT navigation system | ● | ● |
| Bluetooth® interface with HD voice-capable hands-free function and audio streaming for playing music files, cover flow and cover art for displaying album covers, SMS display function, and internet capability. (Bluetooth® features are phone-dependent) | ● | ● |
| CD player (MP3, WMA, AAC, WAV-compatible) | ● | ● |
| Controller on centre console (remote operation of audio and communication system) | ● | ● |
| Media display – 8-inch Media Display | ● | ● |

| Item | Sport | Electric Art |
|---|-------|--------------|
| Mercedes me connect (Remote Online) Onboard use of the remote and location services, e.g. geographic vehicle monitoring, vehicle location, remote door locking and unlocking, remote interrogation of the vehicle status. Remote Online subscription services are limited to three years from the initial registration, and can be extended at an additional cost | ● | ● |
| Mercedes me connect (standard services) Including emergency call system (eCall), accident recovery, breakdown and maintenance management | ● | ● |
| Radio with twin tuner and traffic information decoder (TP/TA) | ● | ● |
| SD card slot | ● | ● |
| Smartphone integration comprising Apple CarPlay™ Please check on www.apple.com/uk/ios/carplay/ for compatibility and approved apps. Certain features and apps require a 3G or 4G data connection. Control of features available through voice control and controller on centre console | ● | ● |
| Two USB connections in centre armrest for external audio devices and storage media (compatible with iPod® and iPhone®, access via vehicle operating system) | ● | ● |



| Item | Sport | Electric Art |
|---|-------|--------------|
| Safety and Assistance Systems | | |
| Anti-Theft Protection package including anti-theft alarm system with tow-away protection and interior monitoring system | ● | ● |
| Acceleration Skid Control (ASR) | ● | ● |
| Active Brake Assist | ● | ● |
| Airbags - automatic front passenger airbag deactivation | ● | ● |
| Airbags - for driver and front passenger | ● | ● |
| Airbags - kneebag for driver | ● | ● |
| Airbags - sidebags for driver and front passenger (combined thorax/pelvis bag) | ● | ● |
| Airbags - windowbags | ● | ● |
| ATTENTION ASSIST - alerts the driver to increasing fatigue and inattention | ● | ● |
| Braking - adaptive Brake Assist with HOLD function and Hill Start Assist | ● | ● |
| Braking - adaptive brake lamps (flash under emergency braking) | ● | ● |
| Braking - anti-lock braking system (ABS) | ● | ● |
| Braking - Brake Assist (BAS) with brake servo assistance when emergency braking is detected | ● | ● |

| Item | Sport | Electric Art |
|--|-------|--------------|
| Braking - electric parking brake | ● | ● |
| Childproof rear doors (manually operated) and rear electric windows (electrically operated) | ● | ● |
| Crash-responsive emergency lighting - automatic activation of interior lighting in the event of an accident | ● | ● |
| Electronic immobiliser | ● | ● |
| Emergency call system (eCall) | ● | ● |
| First-aid kit and warning triangle | ● | ● |
| Locking - remote central locking with interior switch, speed-dependent automatic locking (can be deactivated) and crash sensor with emergency opening function | ● | ● |
| Parking - reversing camera with dynamic guidelines on central display | ● | ● |
| Seats - height-adjustable head restraints (5) | ● | ● |
| Seat belts - status display for rear seat belts in instrument cluster | ● | ● |
| Seat belts - three-point seat belts (5) | ● | ● |
| Tyres - TIREFIT with tyre inflation compressor | ● | ● |
| Tyres - tyre pressure monitoring system (with tyre pressure display in instrument cluster) | ● | ● |



> View offers



> Book a test drive



> Find a Retailer



> View the Range Guide

A revolution in style

| Item | Notes | | 69R | ● | - | Basic RRP excl. VAT (£) | Total RRP incl. VAT (£) |
|--|-------|--|-------|---|---|----------------------------|----------------------------|
| Wheels | | | Sport | - | - | - | - |
| Notes | | | - | - | - | - | - |
| Electric Art | | | - | - | - | - | - |
| 17" alloy wheels (4) - multi-spoke design, painted himalaya grey 225/50 tyres | | | 69R | ● | - | - | - |
| 18" alloy wheels (4) - multi-spoke design, painted matt black with a high-sheen finish 225/45 tyres | | | 04R | - | ● | - | - |

● Standard ○ Optional - Not available



> View offers



> Book a test drive



> Find a Retailer



> View the Range Guide

Driving Assistance package



Blind Spot Assist



Lane Keeping Assist

Safety is at the heart of this package. It features the renowned Mercedes-Benz PRE-SAFE® anticipatory safety system which offers extensive all-round protection. Blind Spot Assist alerts you to unseen obstacles behind you, while Lane Keeping Assist warns you if you unintentionally stray out of the lane.

Driving Assistance package (code DP2) – designed and priced as a package, including items as listed below. **Total incl. VAT £875.00**

Driving Assistance package comprises:

Blind Spot Assist

Visible warning in exterior mirrors if vehicle is detected in the blind spot. Audible warning if indicating to move out of lane when a vehicle is detected in the blind spot

Lane Keeping Assist

Vibrates the steering wheel when detecting unintentional drifting out of lane

PRE-SAFE® anticipatory safety system

If the system detects a critical driving situation, preventive occupant protection measures are initiated, including reversible seat belt tensioning, adjustment of passenger seat positions (if Memory package is fitted)



> View offers



> Book a test drive



> Find a Retailer



> View the Range Guide

Energy Assist package



Acoustic presence indicator



Privacy glass



Radar-based regeneration



Range Plus

The Energy Assist package comes with heated windscreen and a radar-based regeneration, ensuring a more efficient drive. Range Plus adds another 18 miles of range thanks to further efficiency measures including additional insulation and all-round privacy glass. As part of acoustic presence indicator, pedestrians and cyclists can be warned of the car's presence at speeds up to 18 mph.

Energy Assist package (code DP9) – designed and priced as a package, including items as listed below. **Total incl. VAT £945.00**

Energy Assist package comprises:

Acoustic presence indicator

Emits audible warning up to 18 mph alerting pedestrians/cyclists of car's presence.
Warning inaudible from interior of the vehicle

Heated windscreen

Good visibility restored quickly even if the windscreen is iced up – with no scraping required

Privacy glass

Heat-insulating dark-tinted glass all round from B-pillars to keep cabin cool in hot conditions and reduce heat from escaping in cold temperatures

Radar-based regeneration

The recuperation power is automatically adjusted to the current traffic situation, leading to more efficient driving, lower consumption and a higher range

Range Plus

Provides an additional 18 miles of range taking the total to 142 miles during the next charge cycle



Exclusive package



Leather upholstery - lava black

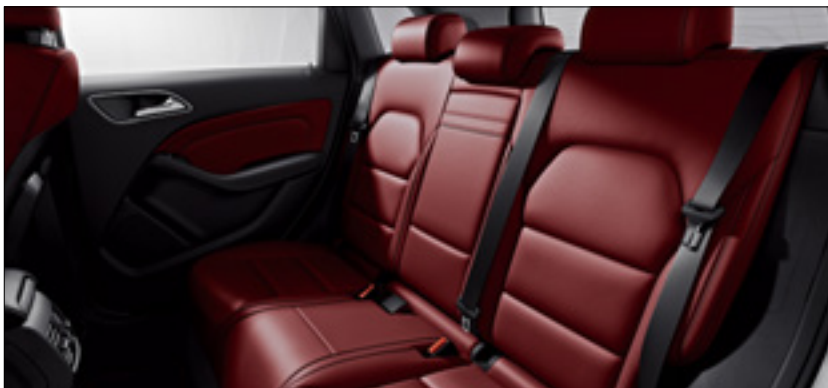

Leather upholstery - cranberry red

For an added touch of luxury, the Exclusive package includes leather upholstery in a choice of three elegant colours, as well as floor mats with matching colour edging. The Exclusive package is available only in conjunction with Executive or Premium equipment line.

Exclusive package (code P34) – designed and priced as a package, including items as listed below.

Electric Art

Total incl. VAT £895.00



Exclusive package comprises:

Floor mats with edging in upholstery colour

Leather upholstery - lava black, hazelnut brown or cranberry red

Trim - brown open-pore eucalyptus wood or high-gloss black ash wood

Exclusive package upholstery and trim

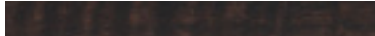
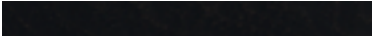
| Lava black | Hazelnut brown | Cranberry red |
|---|---|---|
|  |  |  |
|  | |  |

[View offers](#)[Book a test drive](#)[Find a Retailer](#)[View the Range Guide](#)

Optional equipment

| Item | Notes | | Sport | Electric Art | Basic RRP excl. VAT (£) | Total RRP incl. VAT (£) |
|--|--|-----|-----------------------|-----------------------|----------------------------|----------------------------|
| Exterior | | | | | | |
| Headlamps – Intelligent Light System Bi-xenon headlamps with LED daytime running lamps, Adaptive Highbeam Assist, cornering light function, headlamp wash and LED rear lamps | Only in conjunction with Premium equipment line (code DP0) | 621 | <input type="radio"/> | <input type="radio"/> | 362.50 | 435.00 |
| Privacy glass | Included in Energy Assist package (code DP9) | 840 | <input type="radio"/> | <input type="radio"/> | 245.83 | 295.00 |
| Interior | | | | | | |
| Memory package Electrically adjustable driver and front passenger seats with three individually selectable settings Four-way lumbar support for driver and front passenger | | 275 | <input type="radio"/> | <input type="radio"/> | 412.50 | 495.00 |
| Four-way lumbar support | Included in Exclusive package (code P34) | U22 | <input type="radio"/> | <input type="radio"/> | 133.33 | 160.00 |
| KEYLESS-GO – keyless locking, unlocking and start of the vehicle | | 889 | <input type="radio"/> | <input type="radio"/> | 354.17 | 425.00 |
| Rear dividing net – restricts movement of items from luggage compartment to passenger compartment | | U40 | <input type="radio"/> | <input type="radio"/> | 104.17 | 125.00 |
| Paint, Trim and Upholstery | | | | | | |
| Paint – metallic | | ' | <input type="radio"/> | <input type="radio"/> | 495.83 | 595.00 |



| Item | Notes | | Sport | Electric Art | Basic RRP excl. VAT (£) | Total RRP incl. VAT (£) |
|--|--|-----|-----------------------|-----------------------|----------------------------|----------------------------|
| Communications and In-Car Entertainment | | | | | | |
| COMAND Online system ¹ Android Auto and Apple CarPlay, hard disk drive (HDD) navigation with 3D map display, Live Traffic Information and European map data updates free of charge for the first three years. Single CD/DVD and LINGUATRONIC voice control. Access to internet sites when vehicle is stationary, plus unrestricted use of Mercedes-Benz apps (internet-enabled mobile phone required). Integrated WLAN hotspot for onboard access of WLAN-enabled devices | In conjunction with Executive and Premium equipment lines (code DP3 and DP0). Please check on www.apple.com/uk/ios/carplay/ or www.android.com/intl/en_uk/auto for compatibility and approved apps | 531 | <input type="radio"/> | <input type="radio"/> | 829.17 | 995.00 |
| DAB digital radio tuner | Not in conjunction with Energy Assist package (code DP9) | 537 | <input type="radio"/> | <input type="radio"/> | 358.33 | 430.00 |
| Garmin® MAP PILOT navigation system 8-inch high-resolution colour display. SD card navigation with instructions on screen and displayed in the instrument cluster. SD card inserted in centre armrest compartment next to USB ports. Includes 3D views with exact visualisation of roads and buildings as well as junction and lane assistants making it easy for drivers to orient themselves. Operation via controller or voice control. Spoken instructions are emitted through the vehicle's built-in speakers. Software and maps can be updated via the internet | Included in Executive and Premium equipment lines (code DP3 and DP0) | 357 | <input type="radio"/> | <input type="radio"/> | 412.50 | 495.00 |
| Surround sound system – Harman Kardon® Logic 7® with Dolby Digital 5.1 and DTS 11 high-performance speakers and additional amplifiers | Only in conjunction with COMAND Online system (code 531). Removes stowage compartment beneath load compartment floor | 810 | <input type="radio"/> | <input type="radio"/> | 566.67 | 680.00 |



> View offers



> Book a test drive



> Find a Retailer



> View the Range Guide

Optional equipment

27

| Item | Notes | Sport | Electric Art | Basic RRP excl. VAT (£) | Total RRP incl. VAT (£) | |
|--|--|-------|-----------------------|----------------------------|----------------------------|--------------|
| Service Package | | | | | | |
| Service Care Service Care allows you to spread the cost of servicing your new car in the Mercedes-Benz Retailer network. Taking out a Service Care plan ensures your servicing needs are taken care of by fully trained Mercedes-Benz Technicians with the added benefit of a Mercedes-Benz service history | Price is based on a monthly rate. Example given is for two services taken over 24 months or three services over 36 months. Further payment options are available. New Service Care prices apply only to vehicles up to 12 months old prior to first service. Price effective from 3 May 2016 | 1 | <input type="radio"/> | <input type="radio"/> | 19.17 | 23.00 |



> View offers



> Book a test drive



> Find a Retailer



> View the Range Guide

Genuine Accessories

We've developed a range of Accessories you can add to help personalise and enhance your B-Class. Your local Mercedes-Benz Retailer can advise on fitting costs of Accessories, where applicable. Further information on our full range of Genuine Accessories can be found on the Mercedes-Benz UK website.



01 | LED Mercedes star projector

The legendary three-pointed star logo is discreetly projected onto the ground alongside your vehicle every time you open the front driver or passenger door. The star automatically disappears once the doors are closed.

RRP £120.00 (incl. VAT), excluding fitting



> View offers



> Book a test drive



> Find a Retailer



> View the Range Guide

Genuine Accessories

29

02 | Shallow boot tub

The boot tub is suitable for transporting shopping. The tub shape with its slightly raised edge is precision-tailored to the load area. Made from impact-resistant, non-slip polypropylene, its structured surface holds the separately available stowage crate in place. Deep boot tub also available.

RRP £88.80 (incl. VAT)

03 | Stowage crate

A secure hold for items which are prone to tip over or slide around, e.g. shopping bags. Adjustable partitioning elements allow crate to be divided into max. four sections. Optimum functionality only in conjunction with shallow boot tub.

RRP £87.50 (incl. VAT)





> View offers



> Book a test drive



> Find a Retailer



> View the Range Guide

04 | All-season floor mats

Robust, washable synthetic material, designed for heavy use. Latest design with recessed areas and raised edge. With distinctive Mercedes-Benz star logo. Price for front and rear mats.

RRP £90.36 (incl. VAT)



05 | Concertina load sill protector

Protects the rear of the car from scratches when you're loading the vehicle and prevents dirt on the car from getting onto your clothes. Practical design – can be connected to reversible mat, shallow boot tub or deep boot tub.

RRP £41.53 (incl. VAT)





> View offers



> Book a test drive



> Find a Retailer



> View the Range Guide

06 | Mercedes-Benz roof boxes

An aerodynamic design, tailored to your Mercedes-Benz. In extremely durable material. Designed for quick, optimised attachment to the basic carrier bars. Particularly convenient loading and unloading thanks to the option of double-sided opening. Lockable from both sides. Available in various sizes.

RRP from £361.64 (incl. VAT)

07 | Alustyle Quickfix roof carrier bars

Aluminium carrier bars, precision-tailored to the body of your B-Class – the perfect basis for a range of Mercedes-Benz transport solutions: ski and snowboard rack, bicycle rack or roof boxes.

RRP £222.50 (incl. VAT)





> View offers



> Book a test drive



> Find a Retailer



> View the Range Guide

Colours and materials

Non-metallic paints

Standard



589 jupiter red¹



650 cirrus white

Metallic paints

Optional



175 elbaite green¹



761 polar silver¹



890 cavansite blue¹



191 cosmos black¹



787 mountain grey¹



990 orient bronze¹

¹Not available on Electric Art Please note that, owing to limitations of on-screen representation, paint colours may differ from those shown



> View offers



> Book a test drive



> Find a Retailer



> View the Range Guide

Upholstery

Sport

ARTICO leather¹



111 black



105 sahara beige



118 crystal grey

Trim

Sport



H81 sail pattern

Electric Art

ARTICO leather¹



121 black with blue contrast topstitching

Electric Art



H81 sail pattern

Exclusive package (Electric Art)

Leather



201 lava black



204 hazelnut brown



207 cranberry red

Exclusive package (Electric Art)



734 brown open-pore eucalyptus wood



736 high-gloss black ash wood

¹Man-made leather



Trim and upholstery combinations

| | Sport | | | Electric Art |
|-----------------------------|-----------------------------|-------------|--------------------|---|
| | ARTICO leather ¹ | | | ARTICO leather ¹ |
| | sahara beige (105) | black (111) | crystal grey (118) | black with blue contrast topstitching (121) |
| Dashboard | | | | |
| Steering wheel | black | black | black | black |
| Upper dashboard trim | black | black | black | black |
| Lower dashboard trim | black | black | crystal grey | black |
| Seats | | | | |
| Seat cushion centre section | sahara beige | black | crystal grey | black |
| Side bolster trim | sahara beige | black | crystal grey | black |
| Head restraint | sahara beige | black | crystal grey | black |
| Seat belt | black | black | black | black |
| Doors | | | | |
| Door pocket | black | black | crystal grey | black |
| Door trim | sahara beige | black | crystal grey | black |
| Roof lining | black | black | grey | black |
| Floor covering | | | | |
| Front and rear | black | black | black | black |
| Boot | black | black | black | black |

¹Man-made leather



Combination options

| | | ARTICO leather ¹ Sport | | | ARTICO leather ¹ Electric Art | Leather (Exclusive package) Electric Art | | | |
|---------------------------------------|--------------------|--------------------------------------|--------------|--------------|---|---|----------------|---------------|--|
| | | black | sahara beige | crystal grey | black with blue contrast topstitching | lava black | hazelnut brown | cranberry red | |
| Non-metallic paints (standard) | | | | | | | | | |
| | 589 jupiter red | ● | △ | ○ | - | - | - | - | |
| | 650 cirrus white | ● | ● | ○ | ● | ● | ● | ● | |
| Metallic paints (optional) | | | | | | | | | |
| | 175 elbaite green | ● | ● | ● | - | - | - | - | |
| | 191 cosmos black | ● | ● | ○ | - | - | - | - | |
| | 761 polar silver | ● | △ | ● | - | - | - | - | |
| | 787 mountain grey | ● | △ | ● | - | - | - | - | |
| | 890 cavansite blue | ● | ● | ● | - | - | - | - | |
| | 990 orient bronze | ● | ○ | ● | - | - | - | - | |

● Recommended

○ Possible

△ Not recommended

- Not available

¹Man-made leather

Please note that, owing to limitations of on-screen representation, paint colours may differ from those shown



Technical data

| | | Electric motor |
|---|----------------|-------------------------------------|
| Model | | B-Class Electric Drive |
| Engine | | |
| Battery type | | lithium-ion high-voltage |
| Electric motor type | | asynchronous |
| Battery capacity | kWh | 28.0 |
| Power ¹ | hp (kW) at rpm | 179 ² (132)/9,900–12,500 |
| Torque ¹ | Nm | 340 |
| On-board charger | kW | 11 |
| Transmission | | |
| Single-speed | | ● |
| Performance | | auto. |
| Acceleration 0–62 mph | sec | 7.9 |
| Top speed | mph | 99.5 |
| Charging time ³ – AC outlet (230 V/13 A) | | 9.1–21.4 |
| Wallbox (400 V/16 A) | hr | 3.0–4.4 |
| Electric power consumption – NEDC ⁴ | kWh/100 km | approx. 16.6* |

| | | Electric motor |
|---|------|------------------------|
| Model | | B-Class Electric Drive |
| Performance (continued) | | auto. |
| Electric range – NEDC ⁴ | m | 124 |
| Emissions standard | | EU6 |
| CO ₂ emissions | g/km | 0 |
| Weights and capacities | | auto. |
| Tyre size – Sport (front/rear) | | 225/50 R 17 |
| Electric Art (front/rear) | | 225/45 R 18 |
| Boot capacity ⁵ (seats down) | l | approx. 1,456 |
| Turning circle | m | 11.0 |
| Kerb weight | kg | 1,725 |
| Perm. Gross Vehicle Weight | kg | 2,170 |
| Insurance | | |
| Group rating | | 15 |
| Insurance ratings may vary depending on model line and specification. Please refer to http://www.thatcham.org/abigrouprating/ for further details | | |

¹Figures for rated output and rated torque according to Regulation (EC) No. 595/2009 in the currently applicable version. ²Peak power; continuous power 65 kW. ³Specified voltage and current values refer to network infrastructure and can be limited by the vehicle. Times are from 20–100% charge using a wallbox (3-phase) or standard socket (single-phase). ⁴New European Driving Cycle. The figures shown were obtained in accordance with the prescribed measuring process (Sec. 2, Nos. 5, 6, 6a of the German Ordinance on Fuel Consumption Labelling for Cars [Pkw-EnVKV] in the applicable version). The figures are not based on an individual vehicle. They are provided solely for the purpose of comparing different vehicle models. It is common that differences occur in real driving conditions compared with these certified laboratory values. *Please see next page for further information. ⁵Figures according to Directive 70/156/EEC as amended by 2000/40/EC.

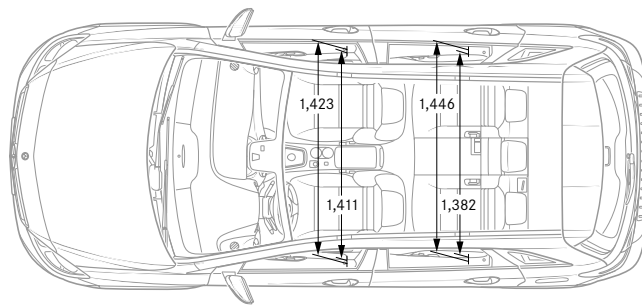
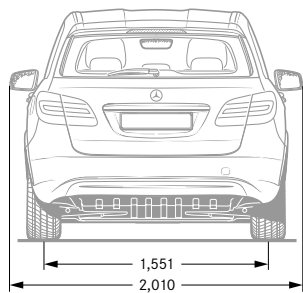
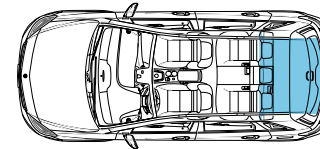
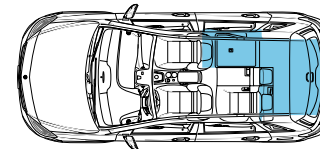
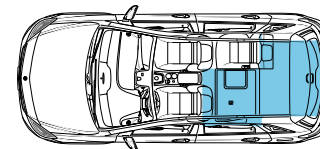
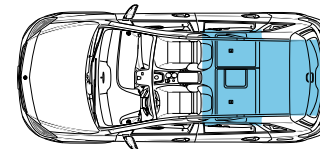
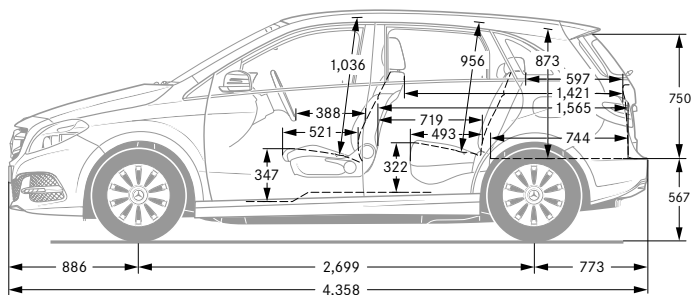
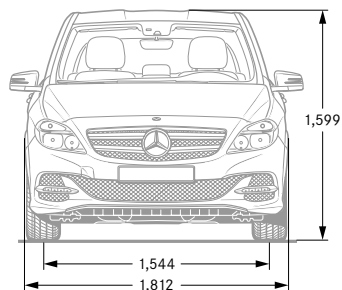

*The manufacturer's stated fuel consumption figures are based on the legally prescribed NEDC test cycle, which is performed in a laboratory. These are the only figures we are allowed to publish.

It is common that differences occur in real driving conditions compared with these certified laboratory values. They result primarily from conditions different from the legally-prescribed laboratory conditions, for example when ambient temperatures differ (the weather is hot, cold, windy, wet), the vehicle is operated under different loads and many other factors.

For several years, Mercedes-Benz has fully and actively supported the early introduction of the WLTP (Worldwide Harmonised Light Vehicles Test Procedure) and the measuring procedure for Real Driving Emissions (RDE). This procedure is designed to supersede the NEDC, with the goal of bringing standardised and real-world consumption closer together.

All measurements in millimetres. The dimensions shown are mean values and apply to standard-specification, unladen vehicles. Dimensions may vary slightly depending on the engine. Please consult your Retailer for further information.

The figures on pages 36-37 are correct at time of publication. Please refer to the government website for latest data - <http://carfueldata.direct.gov.uk/>



> View offers



> Book a test drive



> Find a Retailer



> View the Range Guide

Road Fund Licence



All road vehicle registrations are subject to Vehicle Excise Duty (Road Fund Licence), which varies in accordance with the vehicle's CO₂ emissions. A first year rate for each taxation band will apply. The table below shows the bands (A–M) created by the DVLA and the corresponding Road Fund Licence. CO₂ emissions are listed in the technical data on page 36, and the relevant Excise Duty is reflected in the on-the-road prices on page 7.

| Band | CO ₂ emissions | First year rate (£) | Standard rate (£) | Premium rate (£) ¹ |
|------|---------------------------|---------------------|-------------------|-------------------------------|
| A | 0 g/km | 0.00 | 0.00 | 310.00 |
| B | 1 to 50 g/km | 10.00 | 140.00 | 450.00 |
| C | 51 to 75 g/km | 25.00 | 140.00 | 450.00 |
| D | 76 to 90 g/km | 100.00 | 140.00 | 450.00 |
| E | 91 to 100 g/km | 120.00 | 140.00 | 450.00 |
| F | 101 to 110 g/km | 140.00 | 140.00 | 450.00 |
| G | 111 to 130 g/km | 160.00 | 140.00 | 450.00 |
| H | 131 to 150 g/km | 200.00 | 140.00 | 450.00 |
| I | 151 to 170 g/km | 500.00 | 140.00 | 450.00 |
| J | 171 to 190 g/km | 800.00 | 140.00 | 450.00 |
| K | 191 to 225 g/km | 1,200.00 | 140.00 | 450.00 |
| L | 226 to 255 g/km | 1,700.00 | 140.00 | 450.00 |
| M | over 255 g/km | 2,000.00 | 140.00 | 450.00 |

¹Premium rate only applicable to vehicles where the list price is over £40,000 including any factory-fitted options, standard UK delivery charge, number plates, fuel and VAT



> View offers



> Book a test drive



> Find a Retailer



> View the Range Guide

Services and insurance

Mercedes-Benz Service Care

We believe that servicing costs should be as flexible and affordable as possible for your B-Class Electric Drive, which is why we offer Service Care, an easy way to budget for all your servicing costs. It spreads your bills into manageable payments based on whether you have a new or used Mercedes-Benz.

With Service Care we guarantee the price of parts and labour for up to three services and safeguard against further inflation. It also covers the cost of all recommended service items including brake fluid and screen wash for your B-Class Electric Drive.

You can choose either to add your servicing costs into your monthly spend or pay the full amount in a one-off payment, giving you peace of mind that they are taken care of for the period of the plan.

To receive a personalised Service Care plan recommendation visit the Service Care Calculator at servicecarerates.mercedes-benz.co.uk

Warranty and breakdown cover

Every Mercedes-Benz comes with a three-year unlimited mileage warranty against manufacturing or material defects¹ and up to 30 years warranty against perforation due to corrosion from the inside out.² What's more, it's also covered by Mercedes-Benz Roadside Assistance – a unique package comprising up to 30 years pan-European breakdown assistance.²

Insurance

Since our name is synonymous with reliability, who better to trust with your motor insurance? Mercedes-Benz Insurance provides a motor insurance policy specifically designed to give you the cover you would expect from Mercedes-Benz. For a motor insurance quotation, call **0345 600 2180**.*



> View offers



> Book a test drive



> Find a Retailer



> View the Range Guide

Mercedes me connect

Mercedes me connect enables you to connect to your car via desktop, tablet or smartphone via an app. It provides access to services that enhance your Mercedes-Benz experience and fit effortlessly into your daily digital routine.¹

Standard Services.

Available on all models, except G-Class.

- **Emergency Call** – if there's an accident, this feature automatically shares your vehicle location and status for a fast response from the emergency services
- **Accident & Breakdown Management** – contact our Customer Assistance Centre with a single button for fast breakdown recovery
- **Telediagnosics** – automatically detects and shares details of any vehicle wear and tear with you, and shares the data with your Retailer
- **Maintenance Management** – reminds you when your service is due and automatically shares maintenance data with your Retailer
- **Parking Time Assist** – track the time on your parking meter and receive an alert when it's due to expire



Vehicle Setup.

These services come as standard if you have COMAND Online. Available as an optional £69 upgrade for all other customers.

- **Personal Profile** – store your preferences, such as your favourite radio stations and apps, to create your personal driver profile
- **Maintenance (Vehicle Status)** – check safety information, such as coolant level and brake pad condition, so you can be sure your car is safe and ready to drive
- **Remote Door Unlock** – lock and unlock your car remotely, wherever you are in the world
- **Send to Car Function** – search for destinations on your smartphone, tablet or desktop, then send the routes direct to your car for navigation

¹Currently unavailable in the Channel Islands and the Isle of Man



Remote Online Services.

Standard on all models with COMAND Online, except for new E-Class. Available to purchase for an additional £150.00 (incl. VAT) for all models without COMAND Online.

- **Trip information and vehicle status** – access the vehicle's trip data such as fuel level, mileage, condition of brake pads and tyre pressure
- **Remote door locking and unlocking** – lock and unlock your car remotely, wherever you are in the world
- **Geofencing** – set up a geographical boundary and receive alerts whenever your car enters or leaves this area
- **Parked Vehicle Locator** – locate your parked vehicle within a range of one mile and plot a route back to it
- **Vehicle Tracker** – track the location of your car anywhere in the world

Additional services for Plug-In Hybrid and electric models only, as part of Remote Online services:

- **Pre-entry climate control** – activate the pre-entry climate control system of your parked vehicle and set the temperature to your liking before boarding
- **Route planning** – displays the electric operating range on a map and enables you to plan a route while stopping at public charging stations
- **Charging points** – displays a list of the nearest public charging stations
- **Charging profile** – control the charging settings from a distance so your vehicle can be ready charged when you need it

Vehicle Monitoring.

Standard with COMAND Online for all models, except the new E-Class. Available to purchase for new E-Class and all other customers as an additional £69 upgrade.

- **Geo-fencing** – set up a geographical boundary and receive alerts whenever your car enters or leaves this area
- **Parked Vehicle Locator** – locate your parked car when within 1 mile and plot a route back to it
- **Vehicle Tracker** – track the location of your car anywhere in the world

Visit the Mercedes me connect store for more information:

shop.mercedes-benz.com/en-gb/connect



Mercedes-Benz Finance

Why should you finance with Mercedes-Benz?

At Mercedes-Benz we believe a great driving experience should be matched by an equally great ownership experience. That is why we put just as much thought, time and effort into designing our finance options, our service plans and our insurance cover as we do into our vehicles.

We are not in the business of simply providing a loan to fund the purchase of your dream vehicle. We look on it as a journey that we take with you, from the moment you choose your new Mercedes-Benz, to helping you in choosing your next one.

If you would like to find out more about any of our current offers, simply call into your local Mercedes-Benz Retailer where one of our Business Managers will be more than happy to talk you through anything you need to know.

Helping you find the right solution.

You should find our finance packages are more convenient than a traditional personal loan because:

- Funds are immediately available – no waiting for cheques or loans to clear.
- There is no security required – either against your home or other assets.
- We have clear and transparent rates – the APR we quote is the APR you get.
- We have friendly Business Managers – experts in vehicle finance who can talk you through all of your plans in detail.

One of our most popular finance products is Mercedes-Benz Agility (our Personal Contract Purchase product). We also offer Contract Hire, Operating Lease and Hire Purchase solutions. If you would like to find out more about these speak to your Retailer or visit www.mercedes-benz.co.uk/fandi.

Mercedes-Benz Agility (our PCP product).

At the start of an Agility agreement, you put down a deposit and decide the term of your agreement and your annual mileage. You will be advised of the Guaranteed Future Value, which offers you the reassurance of knowing exactly what you will need to pay to own the vehicle outright in the future (this is known as the Optional Purchase Payment).

Throughout your agreement you simply pay your agreed monthly payments and when the agreement comes to an end you either purchase, hand back or part-exchange your vehicle.





Agility features:

- Fixed regular payments mean you can easily budget.
- Payments are based only on a proportion of the vehicle's value, keeping your monthly payments lower.
- Our Guaranteed Future Value avoids the risk of unplanned depreciation of your vehicle.
- You defer your ownership decision until the end of the agreement.

At the end of your agreement you have three options to choose from.

Option 1: Purchase your Mercedes-Benz.

Purchase your Mercedes-Benz by paying the Optional Purchase Payment and Purchase Activation Fee.¹ This will complete the purchase of your Mercedes-Benz, leaving you free to simply enjoy your vehicle.

Option 2: Hand back your Mercedes-Benz.

If you decide to return your vehicle to us, it must be in line with our Vehicle Return Standards,^{*} as vehicle condition, excess mileage and other charges may be payable.

Option 3: Part-Exchange for a new vehicle.

Purchase your Mercedes-Benz by paying the Optional Purchase Payment and Purchase Activation Fee.¹ This will complete the purchase of your Mercedes-Benz, leaving you free to part-exchange for a new vehicle.

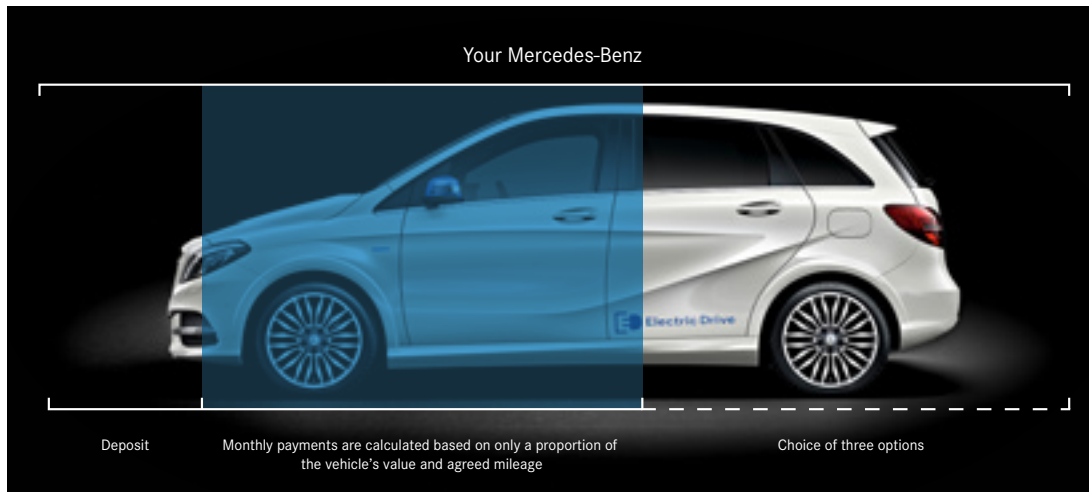

¹Please note the 'Purchase Activation Fee' of £10 will be debited from your account ^{*}To find out more information about our Vehicle Return Standards please visit <http://mercedes-benz.co.uk/vrs>



Chargemaster Homecharge – simple steps to effortless charging

When you purchase a Mercedes-Benz plug-in vehicle we recommend Chargemaster, our preferred charging partner. The 3.6 kW Chargemaster Homecharge allows you to charge your electric car in just 2 hours.¹

Key benefits of the 3.6 kW Chargemaster Homecharge:

- 60% faster than a 13 A plug¹

- Ergonomic styling, robust and weatherproof, for indoor or outdoor use

- Designed for users with a domestic address and off-street parking

- Available with £500 OLEV Electric Vehicle Homecharge Scheme (EVHS) Grant (for eligible customers only)²

- POLAR plus network card providing access to the UK's largest public charging infrastructure, with over 5,000 charging points

- Three year product warranty included

HOMECHARGE 3.6 kW: **£279*** inc. VAT & installation



Simple steps to Chargemaster Homecharge:

- Fill in the application form at www.chargemasterplc.com
- Chargemaster will contact you to discuss your household electrics and arrange for specialist installation within two weeks

For further information please contact:

mercedes-benz@chargemasterplc.com or call 01582 399 412



Chargemaster is the UK's leading provider of domestic charging solutions, trusted by more than 50,000 users across the UK and Europe. Manufactured in the UK, Chargemaster offers a wide range of installation services, choice of power output, and flexible data and security options to suit your requirements.

¹Based on 3.6 kW power output for plug-in hybrid vehicles

²The Chargemaster Homecharge £500 Grant (including VAT) is only available to customers who meet the criteria of the Office of Low Emission Vehicles (OLEV) and is provided and installed by Chargemaster plc. For full details and eligibility criteria for the OLEV EVHS Grant, see <https://www.gov.uk/government/publications/electric-vehicle-homecharge-scheme-guidance-for-customers-version-21>. For full Chargemaster Homecharge Terms & Conditions visit https://chargemasterplc.com/terms_conditions

*Price includes £500 OLEV EVHS Grant. Price correct at time of publication, subject to change



> View offers



> Book a test drive





> Find a Retailer



> View the Range Guide

Follow us on the following social media channels:

 facebook.com/mercedesbenzuk

 twitter.com/mercedesbenzuk

 youtube.com/mercedesbenzuk

 instagram.com/mercedesbenzuk

Effective from 1 March 2017 Production. Information correct at time of publication.

Prices and specifications are subject to change without prior notice.

MBW242PL/0717

Mercedes-Benz Cars UK Limited, Tongwell, Milton Keynes, MK15 8BA. Company number 2448457. www.mercedes-benz.co.uk