



> Book a test drive



> Find a Retailer



> View the Range Guide

A-Class

Hatchback and Saloon



Effective from January 2019 Production.

Mercedes-Benz





> Book a test drive



> Find a Retailer



> View the Range Guide

The hard facts to melt your heart

At Mercedes-Benz we appreciate the importance of detail. Over the following pages you'll find model prices and a breakdown of standard and optional equipment, as well as details of the comprehensive services and benefits that are available to every Mercedes-Benz driver.

Of course, some things have to be experienced to be truly appreciated, such as the qualities that set a Mercedes-Benz apart. Which is why we'd like to invite you for a test drive at your local Mercedes-Benz Retailer. Alternatively, you can make arrangements by visiting www.mercedes-benz.co.uk/testdrive

For more information visit www.mercedes-benz.co.uk or call 0333 222 0500.



> Book a test drive



> Find a Retailer



> View the Range Guide

Contents

11 Model prices

14 Model lines

25 Executive, Premium and Premium Plus equipment lines

28 Mercedes-AMG A 35 4MATIC

31 AMG Executive, Premium and Premium Plus equipment lines

34 Pricing summary for model and equipment lines

36 Introducing MBUX

37 Mercedes-AMG driver training

39 Standard equipment

46 Wheels

48 Optional packages

53 Optional equipment

54 Colours and materials

61 Technical data

72 Road Fund Licence

73 Services and insurance

74 Mercedes me

76 Mercedes-Benz Finance



> Book a test drive



> Find a Retailer



> View the Range Guide

4



Some of the model features, optional extras and colours shown may not be available, or may only be available in a different specification.



> Book a test drive



> Find a Retailer



> View the Range Guide

5



Some of the model features, optional extras and colours shown may not be available, or may only be available in a different specification.



> Book a test drive



> Find a Retailer



> View the Range Guide





> Book a test drive



> Find a Retailer



> View the Range Guide

7



Some of the model features, optional extras and colours shown may not be available, or may only be available in a different specification.



> Book a test drive



> Find a Retailer



> View the Range Guide



Some of the model features, optional extras and colours shown may not be available, or may only be available in a different specification.



> Book a test drive



> Find a Retailer



> View the Range Guide



Some of the model features, optional extras and colours shown may not be available, or may only be available in a different specification.



> Book a test drive



> Find a Retailer



> View the Range Guide



Some of the model features, optional extras and colours shown may not be available, or may only be available in a different specification.



Model prices – Hatchback

Engine	Model line	Transmission	CO ₂ ^{1,*}	Basic RRP excl. VAT (£)	Total RRP incl. VAT (£)	Road Fund Licence (£) ²	Rec. OTR price (£) ³	P11D value (£)	BiK tax rate 2019/20 (%)
A 180 d Diesel – 1,461 cc, 4-cylinder, 116 hp/85 kW	SE	7G-DCT 7-speed automatic	108	20,954.17	25,145.00	170.00	26,030.00	25,805.00	29
	Sport	7G-DCT 7-speed automatic	111	22,204.17	26,645.00	210.00	27,570.00	27,305.00	30
	AMG Line	7G-DCT 7-speed automatic	111	23,204.17	27,845.00	210.00	28,770.00	28,505.00	30
A 200 d Diesel – 1,950 cc, 4-cylinder, 150 hp/110 kW	Sport	8G-DCT 8-speed automatic	110	23,287.50	27,945.00	150.00	28,810.00	28,605.00	26
	AMG Line	8G-DCT 8-speed automatic	110	24,287.50	29,145.00	150.00	30,010.00	29,805.00	26
A 220 d Diesel – 1,950 cc, 4-cylinder, 190 hp/140 kW	AMG Line	8G-DCT 8-speed automatic	114	25,579.17	30,695.00	170.00	31,580.00	31,355.00	26
A 180 Petrol – 1,332 cc, 4-cylinder, 136 hp/100 kW	SE	6-speed manual	127	18,495.83	22,195.00	170.00	23,080.00	22,855.00	29
		7G-DCT 7-speed automatic	119	19,829.17	23,795.00	170.00	24,680.00	24,455.00	27
	Sport	6-speed manual	129	19,745.83	23,695.00	170.00	24,580.00	24,355.00	29
		7G-DCT 7-speed automatic	122	21,079.17	25,295.00	170.00	26,180.00	25,955.00	28
	AMG Line	6-speed manual	129	20,745.83	24,895.00	170.00	25,780.00	25,555.00	29
		7G-DCT 7-speed automatic	122	22,079.17	26,495.00	170.00	27,380.00	27,155.00	28
A 200 Petrol – 1,332 cc, 4-cylinder, 163 hp/120 kW	Sport	6-speed manual	136	21,037.50	25,245.00	210.00	26,170.00	25,905.00	31
		7G-DCT 7-speed automatic	123	22,370.83	26,845.00	170.00	27,730.00	27,505.00	28
	AMG Line	6-speed manual	136	22,037.50	26,445.00	210.00	27,370.00	27,105.00	31
		7G-DCT 7-speed automatic	123	23,370.83	28,045.00	170.00	28,930.00	28,705.00	28

¹The indicated values were determined according to the prescribed measurement method – Worldwide Harmonised Light Vehicle Test Procedure (WLTP). Figures shown may include options which are not available in the UK.

*CO₂ figures have been converted into NEDC-equivalent values for use with the current VED and BiK tax legislation.

Figures shown are for comparability purposes; only compare with other cars tested to the same technical procedures. Figures may not reflect real life driving results, which will depend upon a number of factors including factory-fitted options, accessories fitted (post registration), variations in weather, driving styles and vehicle load. Further information about the test used to establish fuel consumption and CO₂ figures can be found at <http://www.mercedes-benz.co.uk/WLTP>

²A 200 d and A 220 d Hatchback engines are RDE (Real Driving Emissions) Step 2 Certified (Euro 6d). This results in a lower VED and BiK rate as these engines will not be subject to the diesel surcharge. A different first year rate of Vehicle Excise Duty (Road Fund Licence) applies for new cars. Please refer to page 72 for the relevant rate for the second and subsequent years

³The recommended on-the-road price includes the Road Fund Licence applicable to the standard model plus delivery charge (£635.00 incl. VAT), new vehicle registration fee (£55.00) and number plates (£25.00 incl. VAT). VAT is calculated at the standard rate of 20%

[> Book a test drive](#)[> Find a Retailer](#)[> View the Range Guide](#)

Model prices | Hatchback

12

Engine	Model line	Transmission	CO ₂ ^{1,*}	Basic RRP excl. VAT (£)	Total RRP incl. VAT (£)	Road Fund Licence (£) ²	Rec. OTR price (£) ³	P11D value (£)	BiK tax rate 2019/20 (%)
A 220 Petrol – 1,991 cc, 4-cylinder, 190 hp/140 kW	AMG Line	7G-DCT 7-speed automatic	141	23,870.83	28,645.00	210.00	29,570.00	29,305.00	32
A 220 4MATIC Petrol – 1,991 cc, 4-cylinder, 190 hp/140 kW	AMG Line	7G-DCT 7-speed automatic	148	25,204.17	30,245.00	210.00	31,170.00	30,905.00	33
A 250 Petrol – 1,991 cc, 4-cylinder, 224 hp/165 kW	AMG Line	7G-DCT 7-speed automatic	141	24,620.83	29,545.00	210.00	30,470.00	30,205.00	32
Mercedes-AMG									
Mercedes-AMG A 35 4MATIC Petrol – 1,991 cc, 4-cylinder, 306 hp/225 kW	–	7G-DCT 7-speed automatic	167	28,625.00	34,350.00	530.00	35,595.00	35,010.00	37

¹The indicated values were determined according to the prescribed measurement method – Worldwide Harmonised Light Vehicle Test Procedure (WLTP). Figures shown may include options which are not available in the UK.

*CO₂ figures have been converted into NEDC-equivalent values for use with the current VED and BiK tax legislation.

Figures shown are for comparability purposes; only compare with other cars tested to the same technical procedures. Figures may not reflect real life driving results, which will depend upon a number of factors including factory-fitted options, accessories fitted (post registration), variations in weather, driving styles and vehicle load. Further information about the test used to establish fuel consumption and CO₂ figures can be found at <http://www.mercedes-benz.co.uk/WLTP>

²A 200 d and A 220 d Hatchback engines are RDE (Real Driving Emissions) Step 2 Certified (Euro 6d). This results in a lower VED and BiK rate as these engines will not be subject to the diesel surcharge. A different first year rate of Vehicle Excise Duty (Road Fund Licence) applies for new cars. Please refer to page 72 for the relevant rate for the second and subsequent years

³The recommended on-the-road price includes the Road Fund Licence applicable to the standard model plus delivery charge (£635.00 incl. VAT), new vehicle registration fee (£55.00) and number plates (£25.00 incl. VAT). VAT is calculated at the standard rate of 20%



Model prices – Saloon

Engine	Model line	Transmission	CO ₂ ^{1,*}	Basic RRP excl. VAT (£)	Total RRP incl. VAT (£)	Road Fund Licence (£) ²	Rec. OTR price (£) ³	P11D value (£)	BiK tax rate 2019/20 (%)
A 180 d Diesel – 1,461 cc, 4-cylinder, 116 hp/85 kW	Sport	7G-DCT 7-speed automatic	110	22,700.00	27,240.00	170.00	28,125.00	27,900.00	30
	AMG Line	7G-DCT 7-speed automatic	110	23,700.00	28,440.00	170.00	29,325.00	29,100.00	30
A 200 Petrol – 1,332 cc, 4-cylinder, 163 hp/120 kW	Sport	6-speed manual	134	21,533.33	25,840.00	210.00	26,765.00	26,500.00	30
		7G-DCT 7-speed automatic	121	22,866.67	27,440.00	170.00	28,325.00	28,100.00	28
	AMG Line	6-speed manual	134	22,533.33	27,040.00	210.00	27,965.00	27,700.00	30
		7G-DCT 7-speed automatic	121	23,866.67	28,640.00	170.00	29,525.00	29,300.00	28
A 220 4MATIC Petrol – 1,991 cc, 4-cylinder, 190 hp/140 kW	AMG Line	7G-DCT 7-speed automatic	149	25,700.00	30,840.00	210.00	31,765.00	31,500.00	33
A 250 Petrol – 1,991 cc, 4-cylinder, 224 hp/165 kW	AMG Line	7G-DCT 7-speed automatic	139	25,116.67	30,140.00	210.00	31,065.00	30,800.00	31

¹The indicated values were determined according to the prescribed measurement method – Worldwide Harmonised Light Vehicle Test Procedure (WLTP). Figures shown may include options which are not available in the UK.

*CO₂ figures have been converted into NEDC-equivalent values for use with the current VED and BiK tax legislation.

Figures shown are for comparability purposes; only compare with other cars tested to the same technical procedures. Figures may not reflect real life driving results, which will depend upon a number of factors including factory-fitted options, accessories fitted (post registration), variations in weather, driving styles and vehicle load. Further information about the test used to establish fuel consumption and CO₂ figures can be found at <http://www.mercedes-benz.co.uk/WLTP>

²A different first year rate of Vehicle Excise Duty (Road Fund Licence) applies for new cars. Please refer to page 72 for the relevant rate for the second and subsequent years

³The recommended on-the-road price includes the Road Fund Licence applicable to the standard model plus delivery charge (£635.00 incl. VAT), new vehicle registration fee (£55.00) and number plates (£25.00 incl. VAT). VAT is calculated at the standard rate of 20%



> Book a test drive



> Find a Retailer



> View the Range Guide

14

A-Class SE





> Book a test drive



> Find a Retailer



> View the Range Guide



15

Standard ARTICO man-made leather/Bertrix fabric (black)



Options shown: iridium silver metallic paint (code 775A); Active Parking Assist with PARKTRONIC - available with Executive equipment line (code PYM)



The new A-Class redefines the compact class with previously unseen levels of luxury and advanced technology. The dramatic exterior of the A-Class SE features a diamond grille with black pins, a silver-painted louvre and chrome insert – all framed by halogen headlamps with LED daytime running lamps. 16" 5-twin-spoke alloy wheels complement the powerful stance. The interior champions cutting-edge technology with the MBUX infotainment system at

the heart of the innovative cockpit. The coloured turbine-style air vents are equally eye-catching. For your comfort, there is air conditioning and a wealth of features with semi-autonomous driving capabilities. The seats are fitted with black ARTICO man-made leather and Bertrix fabric, while the multifunction sports steering wheel is finished with leather, black topstitching and a black bezel.

Exterior

- 16" alloy wheels – 5-twin spoke design, painted vanadium silver
- Active Brake Assist
- Active Lane Keeping Assist
- ATTENTION ASSIST
- Black weather strip
- Diamond grille with pins in black, silver-painted louvre and insert in chrome
- DYNAMIC SELECT with drive programs Eco, Comfort, Sport and Individual
- Speed Limit Assist

Interior

- 7" instrument display
- 7" touchscreen media display
- Air conditioning
- ARTICO man-made leather/Bertrix fabric (black)
- Coloured inserts in air vents
- Comfort seats
- Cruise Control with Limiter
- DAB digital radio
- Halogen headlamps with integral LED daytime running lamps
- Hard-disk navigation with 3 years free Live Traffic Information
- KEYLESS-GO starting function
- Luggage nets on driver and front-passenger backrests
- MBUX multimedia system

- Multifunction sports steering wheel in leather, black topstitching and black bezel
- Speed-sensitive power steering
- Touchpad
- USB interface in oddments tray and two USB (type C) interfaces in rear of centre console

Trim and Upholstery

- ARTICO man-made leather/Bertrix fabric upholstery (black)





> Book a test drive



> Find a Retailer



> View the Range Guide

A-Class Sport



17

Options shown: Active Parking Assist with PARKTRONIC – available with Executive equipment line (code PYM); iridium silver metallic paint (code 775A)



Options shown: Panoramic glass sunroof (black roof lining as standard) – available with Premium Plus equipment line (code PYO)



> Book a test drive



> Find a Retailer



> View the Range Guide

18



Options shown: Active Parking Assist with PARKTRONIC – available with Executive equipment line (code PYM); iridium silver metallic paint (code 775A)



Options shown: Panoramic glass sunroof (black roof lining as standard) – available with Premium Plus equipment line (code PYO)



> Book a test drive



> Find a Retailer



> View the Range Guide



19

Options shown above and below: 10.25" media display and 10.25" instrument display, available with Premium equipment line (code PYN)



Standard ARTICO man-made leather/Fléron fabric (black)



> Book a test drive



> Find a Retailer



> View the Range Guide

The A-Class Sport emphasises its athletic exterior with LED high performance headlamps, 17" 10-spoke alloy wheels, and chrome weather strips. While it's equipped with the same cutting edge technology as the A-Class SE, the A-Class Sport interior reinforces the sporty theme with black ARTICO

man-made leather and Fléron fabric against a dark carbon-fibre look trim. The leather-clad multifunction sports steering wheel features black topstitching and a bezel in silver chrome. To complement the luxurious feel, two-zone automatic climate control is also fitted as standard.

In addition/replacement to SE:

Exterior

- 17" alloy wheels – 10-spoke design, painted vanadium silver
- Chrome weather strip
- LED High Performance headlamps

Interior

- ARTICO man-made leather/Fléron fabric (black)
- Multifunction sports steering wheel in leather, black topstitching and bezel in silver chrome
- Trim in dark carbon fibre look
- Two-zone automatic climate control

Trim and Upholstery

Dark carbon fibre look



ARTICO man-made leather/Fléron fabric (black)





> Book a test drive



> Find a Retailer



> View the Range Guide

A-Class AMG Line



21

Options shown: Active Parking Assist with PARKTRONIC - available with Executive equipment line (code PYM); iridium silver metallic paint (code 775A)



Options shown: Active Parking Assist with PARKTRONIC - available with Executive equipment line (code PYM)



> Book a test drive



> Find a Retailer



> View the Range Guide



Options shown: Active Parking Assist with PARKTRONIC - available with Executive equipment line (code PYM)



Options shown: Active Parking Assist with PARKTRONIC - available with Executive equipment line (code PYM)



> Book a test drive



> Find a Retailer



> View the Range Guide



23

Options shown: light longitudinal-grain aluminium trim (code H44); and 10.25" media display available only with Executive equipment line (code PYM)



Standard ARTICO man-made leather/DINAMICA microfibre (black). Hatchback seats shown above



The AMG Line demonstrates the athletic qualities of the A-Class in typical AMG form: AMG bodystyling includes an AMG front apron with chrome front splitter, AMG side sill panels and an AMG rear apron with chrome trim and visible exhaust tailpipes. The diamond radiator grille is finished with chrome pins and a single louvre, while 18" AMG 5-twin spoke alloy wheels create a powerful stance. Further highlights of the AMG Line interior

include ARTICO man-made leather and DINAMICA microfibre upholstery, DINAMICA microfibre door lining, plus the option of a longitudinal-grain aluminium trim. The 3-spoke nappa leather multifunction sports steering wheel with a flattened bottom section and perforated grip area takes its inspiration from motor racing.

In addition/replacement to Sport:

Exterior

18" AMG alloy wheels – 5-twin-spoke design, painted titanium grey with high-sheen finish

AMG bodystyling consisting of AMG front apron with front splitter in chrome, AMG side sill panels and AMG rear apron with chrome trim and visible exhaust tailpipes

Diamond radiator grille with chrome pins and single louvre

Interior

ARTICO man-made leather/DINAMICA microfibre (black) with red contrast stitching

Sports seats

Three-spoke multifunction sport steering wheel in nappa leather with flattened bottom section and perforated grip area

Trim and Upholstery

DINAMICA microfibre (standard)



Light longitudinal-grain aluminium (optional)



ARTICO man-made leather/DINAMICA microfibre (black) with red contrast stitching





> Book a test drive



> Find a Retailer



> View the Range Guide

Executive equipment line for SE, Sport and AMG Line



10.25" media display

The Executive equipment line lets you enjoy each journey that little bit more. It includes the Mirror package, 10.25-inch media display, heated front seats and Active Parking Assist with PARKTRONIC.

Executive equipment line (code PYM) – designed and priced as a package, including items as listed below.

SE, Sport and AMG Line

Total incl. VAT £1,395.00

Executive equipment line comprises:

Mirror package

Electrically folding exterior mirrors and automatically-dimming driver's side mirror and rear view mirror

10.25" media display

Active Parking Assist with PARKTRONIC (including front and rear parking sensors)

Heated front seats

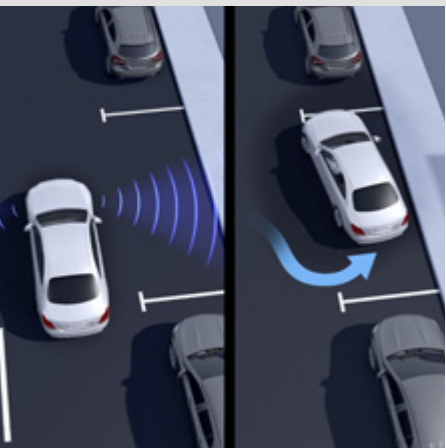

Active Parking Assist with PARKTRONIC



Heated front seats



> Book a test drive



> Find a Retailer



> View the Range Guide

Premium equipment line for Sport and AMG Line



64-colour ambient lighting



Illuminated door sills



KEYLESS-ENTRY

The Premium equipment line – which you can add to Sport or AMG Line – has all the features of the Executive equipment line, as well as ambient lighting, illuminated door sills, the KEYLESS-ENTRY starting function, a rear armrest and a mid-range sound system.

Premium equipment line (code PYN) – designed and priced as a package, including items as listed below.

Sport and AMG Line

Total incl. VAT £2,395.00

Premium equipment line comprises:

Executive equipment line

10.25" instrument cluster

64-colour ambient lighting

225 W mid-range sound system

Illuminated door sills

KEYLESS-ENTRY (lock/unlock)

Rear armrest



> Book a test drive



> Find a Retailer



> View the Range Guide

Premium Plus equipment line for Sport and AMG Line



MULTIBEAM LEDs with Adaptive Highbeam Assist Plus

If you want to take it up a notch, the Premium Plus equipment line for the Sport and AMG Line contains the same features as the Premium equipment line plus front memory seats, MULTIBEAM LEDs with Adaptive Highbeam Assist Plus, and a panoramic glass sunroof.

Premium Plus equipment line (code PYO) – designed and priced as a package, including items as listed below.

Sport and AMG Line

Total incl. VAT £3,595.00

Premium Plus equipment line comprises:

Premium equipment line

Electrically-adjustable front memory seats

MULTIBEAM LEDs with Adaptive Highbeam Assist Plus

Panoramic glass sunroof (black roof lining as standard)



Electrically adjustable front seats



Panoramic glass sunroof



> Book a test drive



> Find a Retailer



> View the Range Guide

28

Mercedes-AMG A 35 4MATIC





> Book a test drive



> Find a Retailer



> View the Range Guide



Optional AMG Executive equipment line with 10.25" media display



Additional-cost option: iridium silver metallic paint (code 775A)



Optional AMG Style package (code DP6)



Optional 19" AMG multi-spoke alloy wheels - part of the AMG Style package (code DP6)



Emotional, agile and digital: the A35 4MATIC joins the Mercedes-AMG performance family. Created for maximum driving dynamics, the AMG front apron and the AMG bodystyling give the A35 4MATIC its specific design identity. DYNAMIC SELECT with different drive programs such as 'Sport' or 'Sport+' adds to the energetic feel. Five-twin-spoke design 18" AMG alloy wheels and silver chrome trims on the louvres in the outer air intakes are

just some of the distinguishing features that create a powerful appearance. Just as impressive as the exterior, the stylish interior is defined by an AMG Performance steering wheel in nappa leather and red designo seat belts. A digital instrument cluster with three AMG display styles takes your driving experience to the next level.

Exterior

- 18" AMG alloy wheels – 5-twin-spoke design, bicolour
- AMG bodystyling including front splitter
- AMG Line front apron with flics on the air intakes
- DYNAMIC SELECT with drive programs 'Slippery', 'Comfort', 'Sport', 'Sport+' and 'Individual'
- Exhaust system featuring automatically-controlled exhaust flap
- AMG radiator grille with twin-blade lamella
- Rear apron with diffuser insert
- Silver chrome trims on louvres in the outer air intakes
- Spoiler lip on the roof
- Two round tailpipes attached to the rear apron
- Wider wheel arches for AMG wheels

Interior

- AMG Performance steering wheel in nappa leather
- designo seat belts in red
- Digital instrument cluster with three AMG display styles and AMG menu

Trim and Upholstery

Light longitudinal-grain aluminium



ARTICO man-made leather / DINAMICA microfibre (black) with red contrast stitching





> Book a test drive



> Find a Retailer



> View the Range Guide

AMG Executive equipment line for Mercedes-AMG A 35 4MATIC



10.25" media display

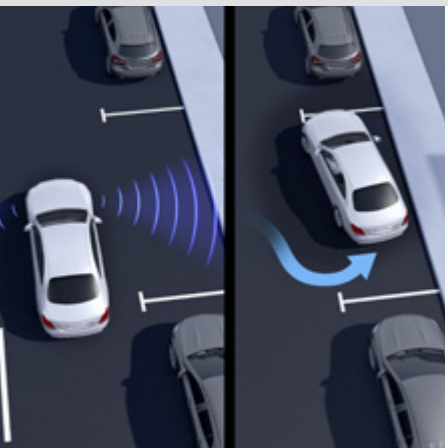

Active Parking Assist with PARKTRONIC

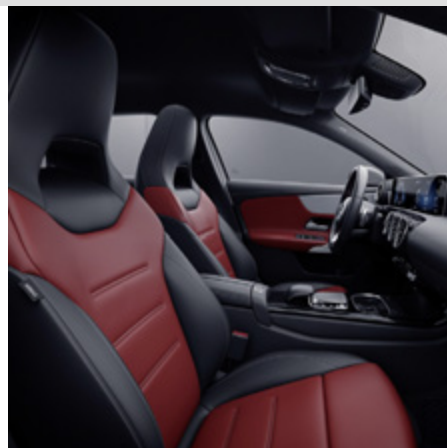

Leather package including upholstery

The AMG Executive equipment line lets you enjoy each journey that little bit more. It includes the Mirror package, 10.25-inch media display, heated front seats, Active Parking Assist with PARKTRONIC and Leather package including upholstery.

AMG Executive equipment line (code PYM) – designed and priced as a package, including items as listed below.

Mercedes-AMG A 35 4MATIC only

Total incl. VAT £1,395.00

AMG Executive equipment line comprises:

Leather package with double topstitching on the beltline and with AMG leather on the door centre panels are matched to the upholstery

Mirror package
Electrically folding exterior mirrors and automatically-dimming driver's side mirror and rear view mirror

10.25" media display

Active Parking Assist with PARKTRONIC (including front and rear parking sensors)

Heated front seats



> Book a test drive



> Find a Retailer



> View the Range Guide

AMG Premium equipment line for Mercedes-AMG A 35 4MATIC



64-colour ambient lighting

The AMG Premium equipment line for Mercedes-AMG A 35 4MATIC has all the features of the AMG Executive equipment line, as well as ambient lighting, illuminated door sills, the KEYLESS-ENTRY starting function, a rear armrest and a mid-range sound system.

AMG Premium equipment line (code PYN) – designed and priced as a package, including items as listed below.

Mercedes-AMG A 35 4MATIC only

Total incl. VAT £2,395.00

AMG Premium equipment line comprises:

Executive equipment line

10.25" instrument cluster

64-colour ambient lighting

225w mid-range sound system

Illuminated door sills

KEYLESS-ENTRY (lock/unlock)

Rear armrest



Illuminated door sills



KEYLESS-ENTRY



> Book a test drive



> Find a Retailer



> View the Range Guide

AMG Premium Plus equipment line for Mercedes-AMG A 35 4MATIC



Burmester® surround sound system



Electrically adjustable front seats



Panoramic glass sunroof

Even better: the AMG Premium Plus equipment line for Mercedes-AMG A 35 4MATIC comes with the same features as the Premium equipment line and more. Beside electrically-adjustable front memory seats, MULTIBEAM LEDs with Adaptive Highbeam Assist Plus and a panoramic glass sunroof, you also get a Burmester® surround sound system.

AMG Premium Plus equipment line (code PYO) – designed and priced as a package, including items as listed below.

Mercedes-AMG A 35 4MATIC only **Total incl. VAT £3,895.00**

AMG Premium Plus equipment line comprises:

Premium equipment line

Burmester® surround sound system replaces mid-range sound system

Electrically-adjustable front memory seats

MULTIBEAM LEDs with Adaptive Highbeam Assist Plus

Panoramic glass sunroof (black roof lining as standard)



Pricing summary for model and equipment lines – Hatchback

Model	Transmission	Recommended OTR price (£) ¹									
		SE	SE Executive	Sport	Sport Executive	Sport Premium	Sport Premium Plus	AMG Line	AMG Line Executive	AMG Line Premium	AMG Line Premium Plus
A 180 d	7G-DCT 7-speed auto.	26,030.00	27,425.00	27,570.00	28,965.00	29,965.00	31,165.00	28,770.00	30,165.00	31,165.00	32,365.00
A 200 d	8G-DCT 8-speed auto.	-	-	28,810.00	30,205.00	31,205.00	32,405.00	30,010.00	31,405.00	32,405.00	33,605.00
A 220 d	8G-DCT 8-speed auto.	-	-	-	-	-	-	31,580.00	32,975.00	33,975.00	35,175.00
A 180	6-speed manual	23,080.00	24,475.00	24,580.00	25,975.00	26,975.00	28,175.00	25,780.00	27,175.00	28,175.00	29,375.00
	7G-DCT 7-speed auto.	24,680.00	26,075.00	26,180.00	27,575.00	28,575.00	29,775.00	27,380.00	28,775.00	29,775.00	30,975.00
A 200	6-speed manual	-	-	26,170.00	27,565.00	28,565.00	29,765.00	27,370.00	28,765.00	29,765.00	30,965.00
	7G-DCT 7-speed auto.	-	-	27,730.00	29,125.00	30,125.00	31,325.00	28,930.00	30,325.00	31,325.00	32,525.00
A 220	7G-DCT 7-speed auto.	-	-	-	-	-	-	29,570.00	30,965.00	31,965.00	33,165.00
A 220 4MATIC	7G-DCT 7-speed auto.	-	-	-	-	-	-	31,170.00	32,565.00	33,565.00	34,765.00
A 250	7G-DCT 7-speed auto.	-	-	-	-	-	-	30,470.00	31,865.00	32,865.00	34,065.00
		Mercedes-AMG	Mercedes-AMG	Mercedes-AMG	Mercedes-AMG						
			AMG Executive	AMG Premium	AMG Premium Plus						
Mercedes-AMG A 35 4MATIC	7G-DCT 7-speed auto.	35,595.00	36,990.00	37,990.00	39,490.00						

¹The recommended on-the-road price includes the Road Fund Licence applicable to the standard model plus delivery charge (£635.00 incl. VAT), new vehicle registration fee (£55.00) and number plates (£25.00 incl. VAT). VAT is calculated at the standard rate of 20%



Pricing summary for model and equipment lines – Saloon

Model	Transmission	Recommended OTR price (£) ¹							
		Sport	Sport Executive	Sport Premium	Sport Premium Plus	AMG Line	AMG Line Executive	AMG Line Premium	AMG Line Premium Plus
A 180 d	7G-DCT 7-speed automatic	28,125.00	29,520.00	30,520.00	31,720.00	29,325.00	30,720.00	31,720.00	32,920.00
A 200	6-speed manual	26,765.00	28,160.00	29,160.00	30,360.00	27,965.00	29,360.00	30,360.00	31,560.00
	7G-DCT 7-speed automatic	28,325.00	29,720.00	30,720.00	31,920.00	29,525.00	30,920.00	31,920.00	33,120.00
A 220 4MATIC	7G-DCT 7-speed automatic	-	-	-	-	31,765.00	33,160.00	34,160.00	35,360.00
A 250	7G-DCT 7-speed automatic	-	-	-	-	31,065.00	32,460.00	33,460.00	34,660.00

¹The recommended on-the-road price includes the Road Fund Licence applicable to the standard model plus delivery charge (£635.00 incl. VAT), new vehicle registration fee (£55.00) and number plates (£25.00 incl. VAT). VAT is calculated at the standard rate of 20%



Introducing MBUX



Optional Premium equipment line shown



Multi-gesture touchpad control

Introducing MBUX, the brand new Mercedes-Benz User Experience infotainment system that can be controlled via voice and touch input. The new A-Class is the first model to feature this innovative way of communicating with your Mercedes-Benz.

MBUX (Mercedes-Benz User Experience) infotainment system comprises:

Voice control

- Activated by the keywords “Hey Mercedes”, the new intelligent voice control LINGUATRONIC¹ lets you control many of the infotainment functions, including destination input, phone calls or music selection
- MBUX is able to understand different accents and will adjust to you over time
- MBUX even understands indirect commands. Feeling chilly? Just say “I feel cold” and MBUX will adjust the temperature for you

Personalisation

- Turn the new A-Class into your very own Mercedes-Benz by personalising driving modes, radio stations, ambient lighting and much more
- Your personal settings can be saved in up to seven different profiles, making your driving experience the best one possible
- Thanks to artificial intelligence, MBUX is able to learn and adapt over time. It will be able to predict your personal habits, such as navigation for frequently-driven routes, or the radio station you like to listen to on your way home from work

Touch inputs

- Beside voice control you can operate MBUX via touchscreen, the touchpad on the centre console, as well as touch control buttons on the steering wheel
- The touchpad recognises your handwriting should you wish to enter addresses or phone numbers silently

Maintenance and service

- Wondering when the next service is due? Or how much further you can drive until you need to stop at a petrol station? Just ask your MBUX – it will tell you the answer

¹LINGUATRONIC off-board functions are currently only available for 3 years



> Book a test drive



> Find a Retailer



> View the Range Guide

Exclusive driver training for Mercedes-AMG owners

All Mercedes-AMG customers are invited to a complimentary AMG Driving Academy Training experience at Mercedes-Benz World.

The AMG Driving Academy Training experience will prepare you to unleash the power and performance of an AMG model with confidence. This four-hour session, including a full safety briefing and debrief, will lay the foundation for mastering a high-performance vehicle on the handling circuits and dynamic low-friction surfaces, with manoeuvres including:

- Slalom handling (dynamic straight)
- Obstacle avoidance (wet straight and dynamic straight)
- Oversteer and understeer (wet skid circle)
- Cornering (handling circuit)

TERMS AND CONDITIONS

The following customers only are eligible: the first purchaser/registered keeper of a newly registered Mercedes-AMG. The complimentary Training as described in the brochure must be booked and taken within six months of delivery of your Mercedes-AMG. The Training is available Monday to Friday and is subject to availability. Requests for Saturday and Sunday will incur an additional charge. Upgrades are available for an additional cost: details upon request. Transferable to individuals who reside at the same postal address only. Mercedes-Benz Cars UK Limited reserves the right to amend or withdraw this Training experience. Attendees must hold a full UK driving licence. Attendees will be required to sign the Mercedes-Benz World Driving Risk Acknowledgement prior to undertaking the Training experience. The Training experience is also subject to the Mercedes-Benz World Terms and Conditions, as applicable. Invitation is emailed to the customer post-delivery. Permission via the customer contact preferences must be given to enable Mercedes-Benz World to contact. Retailer demonstrator vehicles are not eligible.





[▶ Book a test drive](#)



[▶ Find a Retailer](#)



[▶ View the Range Guide](#)





> Book a test drive



> Find a Retailer



> View the Range Guide

Standard equipment



Hard-disk navigation with MBUX technology



Reversing camera



Touchscreen



7-inch cockpit display

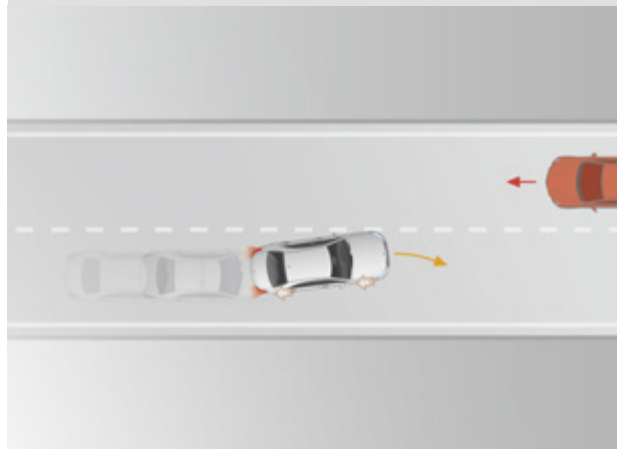

Active Lane Keeping Assist and Speed Limit Assist

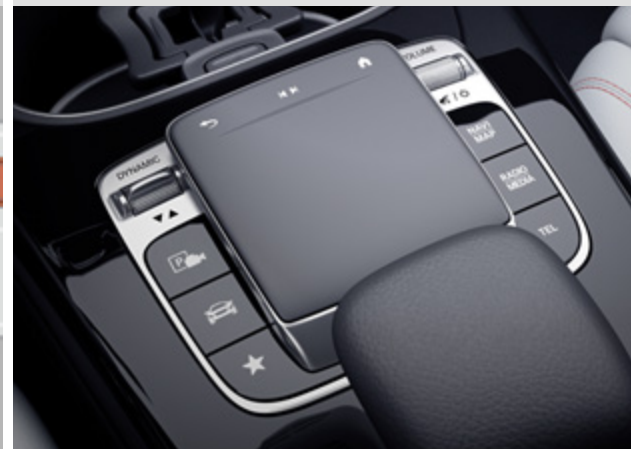

Touchpad



Item	SE	Sport	AMG Line	AMG A 35 4MATIC
Transmission and Suspension				
Cruise Control with Limiter	●	●	●	●
Driving modes – DYNAMIC SELECT with a choice of driving modes: 'Eco', 'Comfort', 'Sport' and 'Individual'	●	●	●	-
Driving modes – DYNAMIC SELECT with drive programs 'Slippery', 'Comfort', 'Sport', 'Sport+' and 'Individual'	-	-	-	●
ECO start/stop function	●	●	●	●
Rear axle (Hatchback) – Torsion Beam Applicable to SE and Sport model lines and A 180 d AMG Line	●	●	●	-
Rear axle (Hatchback) – Multi-Link Applicable to AMG Line (excluding A 180 d) and Mercedes-AMG A35 4MATIC	-	-	●	●
Rear axle (Saloon) – Torsion Beam Applicable to Sport model lines and A 180 d AMG Line	-	●	●	-
Rear axle (Saloon) – Multi-Link Applicable to AMG Line (excluding A 180 d)	-	-	●	-
Summer tyres	●	●	●	●
Suspension – AMG suspension	-	-	-	●
Suspension – lowered comfort suspension	●	●	●	-

Item	SE	Sport	AMG Line	AMG A 35 4MATIC
Exterior				
AMG bodystyling – front apron, rear apron and side skirts	-	-	●	●
Beltline strips – chrome	●	●	●	●
Bodystyling – side skirts, body-coloured	●	●	●	●
Brakes – calipers with 'Mercedes-Benz' lettering on front	-	-	●	●
Brakes – perforated front brake discs AMG Line: engines A 220 d, A 220, A 220 4MATIC and A 250 only	-	-	●	●
Bumpers – body-coloured	●	●	●	●
Door handles – body-coloured With KEYLESS-ENTRY, part of the Premium and AMG Premium equipment lines, the door handles include a chrome accent	●	●	●	●
Door mirrors – electrically adjustable and heated with integrated LED indicators	●	●	●	●
Door sills – front door sills with 'Mercedes-Benz' lettering	●	●	●	●
Exhaust system – no visible tailpipes	●	-	-	-
Exhaust system – twin trapezoidal tailpipes in polished stainless steel	-	●	●	-
Exhaust system – two round tailpipes attached to the rear apron	-	-	-	●
Glass – rear windscreen, heated with timer control	●	●	●	●
Lights – halogen headlamps with integrated daytime running lights	●	-	-	-
Lights – high-level third brake light, LED	●	●	●	●



Item	SE	Sport	AMG Line	AMG A 35 4MATIC
Exterior (continued)				
Lights – LED High Performance headlamps with integrated LED daytime running lights	–	●	●	●
Lights – LED tail lamps	–	●	●	●
Lights – part-LED tail lamps	●	–	–	–
Parking – reversing camera with parking guidelines, 180° view	●	●	●	●
Radiator grille – diamond radiator grille with pins in black, silver-painted louvre and insert in chrome	●	●	–	–
Radiator grille – diamond radiator grille with pins in chrome, silver-painted louvre and insert in chrome	–	–	●	–
AMG radiator grille with twin-blade lamella	–	–	–	●
Wider wheel arches for AMG wheels	–	–	–	●
Wiper system – rear windscreen wiper (Hatchback only)	●	●	●	●

Item	SE	Sport	AMG Line	AMG A 35 4MATIC
Interior				
Seat Comfort package Seat height adjusters and seat cushion angle adjustment on front seats	●	●	●	●
Air conditioning – air vents with surround and cruciform nozzle in silver chrome	●	●	●	●
Air conditioning – THERMATIC	●	–	–	–
Air conditioning – THERMOTRONIC luxury automatic climate control, two-zone, with display	–	●	●	●
Centre armrest – front, with stowage	●	●	●	●
Cup holder – twin, front	●	●	●	●
Floor mats	●	●	–	–
Floor mats – with stitched edging and 'AMG' lettering	–	–	●	●
Freight packaging with tie-down hooks (Saloon only)	–	●	●	–
Freight packaging without tie-down hooks (Hatchback only)	●	●	●	●
Instrument cluster – fluid level warning indicator for fuel, oil, coolant and washer fluid	●	●	●	●
Instrument cluster – outside temperature gauge	●	●	●	●
Instrument cluster – service indicator ASSYST	●	●	●	●
Instrument cluster – trip computer in multifunction display with current consumption indicator (operated via steering wheel)	●	●	●	●



Item	SE	Sport	AMG Line	AMG A 35 4MATIC
Interior (continued)				
Interior lighting – cup holder/stowage compartment	●	●	●	●
Interior lighting – footwell lights in front	●	●	●	●
Interior lighting – handle recess/closing handle (front/rear/left/right)	●	●	●	●
Interior lighting – interior lamp/reading lamp in rear in support plate (rear/left/right)	●	●	●	●
Interior lighting – oddments tray	●	●	●	●
Interior lighting – reading lamps (front/left/right), console downlighter	●	●	●	●
Interior lighting – signal and ambient lamp	●	●	●	●
Interior lighting – signal exit lamp (front/left/right)	●	●	●	●
Interior lighting – touchpad	●	●	●	●
Interior lighting – vanity lights (front/left/right)	●	●	●	●
Light and Sight package	●	●	●	●
Luggage net on driver's and front passenger's backrests	●	●	●	●
KEYLESS-GO starting function	●	●	●	●
Pedals – brushed stainless-steel sports pedals with rubber studs	–	–	●	●
Seats – front seats cushion length adjustment	●	●	●	●
Seats – front seats, manually adjustable	●	●	●	●
Seats – rear seat backrests, split folding (40:20:40)	●	●	●	●

Item	SE	Sport	AMG Line	AMG A 35 4MATIC
Seats – comfort seats with adjustable head restraints	●	●	–	–
Seats – sports seats with adjustable head restraints (Saloon only)	–	–	●	–
Seats – sports seats with integrated head restraints (Hatchback only)	–	–	●	●
Spectacles compartment for driver	●	●	●	●
Steering – Direct-Steer system	●	●	●	●
Steering column – manually adjustable for height and reach	●	●	●	●
Steering wheel – 3-spoke multifunction with gearshift paddles, trimmed in leather	●	●	–	–
Steering wheel – 3-spoke multifunction with galvanised gearshift paddles, trimmed in leather with flattened bottom section and perforated leather in grip area	–	–	●	–
Steering wheel – AMG Performance steering wheel in nappa leather with silver-coloured aluminium gearshift paddles	–	–	–	●
Stowage – compartment in centre console, with retractable cover (automatic only)	●	●	●	●
Stowage – glove compartment, illuminated	●	●	●	●
Stowage – luggage compartment cover (Hatchback only)	●	●	●	●
Sun visor with illuminated vanity mirror	●	●	●	●
Touchpad on centre console	●	●	●	●
Windows – electric windows (4)	●	●	●	●



Item	SE	Sport	AMG Line	AMG A 35 4MATIC
Paint, Trim and Upholstery				
Paint - non-metallic	●	●	●	●
Roof lining - black	●	●	●	●
Trim - dark carbon fibre	-	●	-	-
Trim - DINAMICA microfibre	-	-	●	-
Trim - light longitudinal-grain aluminium	-	-	○	●
Upholstery - ARTICO man-made leather/Bertrix fabric (black)	●	-	-	-
Upholstery - ARTICO man-made leather/Fléron fabric (black)	-	●	-	-
Upholstery - ARTICO man-made leather/DINAMICA microfibre with red contrast stitching	-	-	●	●

Item	SE	Sport	AMG Line	AMG A 35 4MATIC
Communications and In-Car Entertainment				
DAB digital radio tuner	●	●	●	●
Dual Bluetooth® interface, 2 USB ports (type C)	●	●	●	●
Hard-disk navigation	●	●	●	●
“Hey Mercedes” voice activation	●	●	●	●
Instrument display - 7-inch display	●	●	●	●
Live Traffic Information (free for first 3 years)	●	●	●	●
MBUX multimedia system ¹	●	●	●	●
Media display - 7-inch touchscreen display	●	●	●	●
Mercedes me connect (standard services) Including emergency call system (eCall), accident recovery, breakdown management and maintenance management	●	●	●	●
Pre-installation for Mercedes-Benz Link	●	●	●	●
Radio aerial integrated into roof spoiler (Hatchback only)	●	●	●	●
Radio aerial integrated into windshields front and rear (Saloon only)	-	●	●	-



Item	SE	Sport	AMG Line	AMG A 35 4MATIC
Safety and Assistance Systems				
Active Braking Assist – forward collision warning system with autonomous braking intervention	●	●	●	●
Active bonnet – pedestrian safety measure which detects an impact and raises bonnet by 65 mm	●	●	●	●
Active Lane Keeping Assist Can warn drivers when they unintentionally leave their lane and can use one-sided braking intervention to help manoeuvre the vehicle back into its lane	●	●	●	●
Airbags – dual-stage, driver and front passenger	●	●	●	●
Airbags – head and sidebags, driver and front passenger	●	●	●	●
Airbags – kneebag for driver	●	●	●	●
Airbags – windowbags, driver and front passenger	●	●	●	●
AIRPANEL Active radiator shutters open for cooling air, and close when not needed to improve aerodynamics and fuel efficiency (not applicable to A 200 d or A 220 d)	●	●	●	–

Item	SE	Sport	AMG Line	AMG A 35 4MATIC
Alarm system with immobiliser and interior protection – Thatcham category 1 (T1)	●	●	●	●
ATTENTION ASSIST – monitors steering behaviour and can help alert to long journey fatigue	●	●	●	●
Braking – Adaptive Brake Assist with HOLD function and Hill Start Assist	●	●	●	●
Braking – adaptive brake lights	●	●	●	●
Braking – anti-lock braking system (ABS) with Brake Assist (BAS)	●	●	●	●
Braking – brake-pad wear warning indicator	●	●	●	●
Crash-responsive emergency lighting	●	●	●	●
Electric parking brake	●	●	●	●
Electronic Stability Programme (ESP®) with Acceleration Skid Control (ASR)	●	●	●	●
ESP® Curve Dynamic Assist	●	●	●	●
First-aid kit and warning triangle	●	●	●	●



Item	SE	Sport	AMG Line	AMG A 35 4MATIC
Safety and Assistance Systems (continued)				
Headlamp Assist – automatic headlamp activation	●	●	●	●
Lamp failure indicator	●	●	●	●
Locking – childproof locks, manually operated for rear doors and electrically operated for rear power windows	●	●	●	●
Locking – remote central locking and crash sensor with emergency opening function	●	●	●	●
Rain-sensing windscreen wipers with two sensitivity settings	●	●	●	●
Rear fog lamp	●	●	●	●
Seats – automatic child seat recognition sensor (pressure sensor)	●	●	●	●
Seats – ISOFIX and top-tether child seat fixing points in rear (two outer seats)	●	●	●	●
Seats – seat occupancy sensor, front passenger seat	●	●	●	●

Item	SE	Sport	AMG Line	AMG A 35 4MATIC
Seat belts – reminder, front and rear	●	●	●	●
Seat belts – three-point, rear (3)	●	●	●	●
Seat belts – black	●	●	●	○
Seat belts – black Only in conjunction with leather as part of AMG Executive, AMG Premium and AMG Premium Plus equipment line	-	-	-	●
Seat belts – red	-	-	-	●
Tyres – TIREFIT tyre-sealant kit	●	●	●	●
Tyres – tyre pressure monitoring system	●	●	●	●



> Book a test drive



> Find a Retailer



> View the Range Guide

Wheels



R78 16" alloy wheels (4) – 5-twin-spoke design, painted vanadium silver 205/60 tyres

SE	●
Sport	-
AMG Line	-
Mercedes-AMG A 35 4MATIC	-



72R 17" alloy wheels (4) – 10-spoke design, painted vanadium silver 205/55 tyres

SE	-
Sport	●
AMG Line	-
Mercedes-AMG A 35 4MATIC	-



RQS 18" AMG alloy wheels (4) – 5-twin-spoke design, painted titanium grey with a high-sheen finish 225/45 tyres

SE	-
Sport	-
AMG Line	●
Mercedes-AMG A 35 4MATIC	-



> Book a test drive



> Find a Retailer



> View the Range Guide



RQT 18" AMG alloy wheels (4) – 5-twin-spoke design, bicolour 235/40 tyres

SE	–
Sport	–
AMG Line	–
Mercedes-AMG A 35 4MATIC	●



RVL 19" AMG alloy wheels (4) – multi-spoke design, painted matt black with a high-sheen finish 235/35 tyres

SE	–
Sport	–
AMG Line	–
Mercedes-AMG A 35 4MATIC	△



> Book a test drive



> Find a Retailer



> View the Range Guide

Driving Assistance package

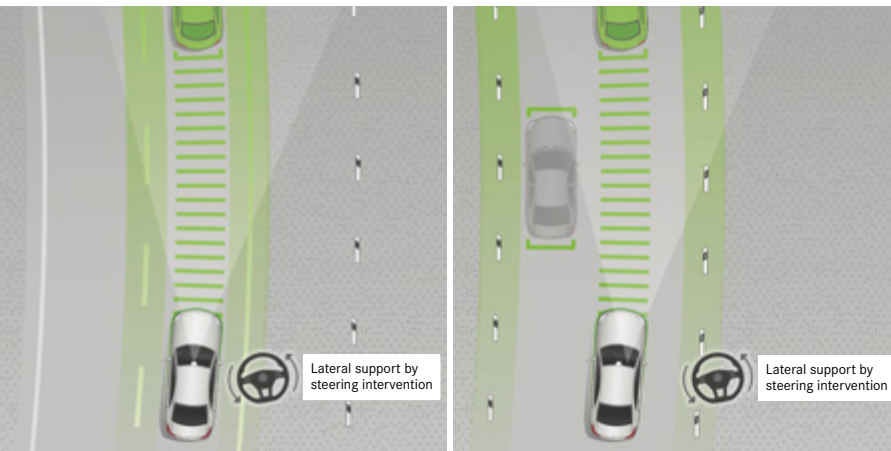

Active Steering Assist



Active Distance Assist DISTRONIC

The Driving Assistance package contains a range of highly intelligent features to help you stay safe on the road – by making the drive more effortless, by warning of danger, and by taking steps to protect you in an emergency.

Driving Assistance package (code 23P) – designed and priced as a package, including items listed below.

Sport, AMG Line and Mercedes-AMG

Total incl. VAT £1,695.00

Only in conjunction with Executive, Premium, Premium Plus, AMG Executive, AMG Premium or AMG Premium Plus equipment lines. Automatic transmission only

Driving Assistance package comprises:

Active Blind Spot Assist can warn the driver of vehicles in the blind spot during a lane change and can help to avoid a collision by means of one-sided braking intervention

Active Braking Assist with cross-traffic function can help to avoid accidents with vehicles ahead, crossing traffic and also pedestrians, and/or mitigate their consequences

Active Distance Assist DISTRONIC helps maintain the desired distance from the vehicle in front

Active Emergency Stop Assist: immediate emergency braking if evasion is impossible

Active Lane-change Assist aids the driver with changing lanes by means of steering torque as soon as the driver initiates the change by activating the direction indicator

Active Speed Limit Assist ensures detected speed limits are automatically adopted as the set speed for Active Distance Assist DISTRONIC

Active Steering Assist: targeted steering intervention to prevent unintentional drifting out of lane

Evasive Steering Assist can support the driver in making evasive manoeuvres if, in a dangerous situation, he/she moves to avoid any pedestrian detected by the system

PRE-SAFE® PLUS: when a rear-end collision threatens, PRE-SAFE® PLUS can initiate preventive measures, including warning following traffic and locking the brakes on standstill

Route-based speed adjustment: adaption of speed before curves, roundabouts and junctions



> Book a test drive



> Find a Retailer



> View the Range Guide

Advanced Navigation package



MBUX augmented reality for navigation

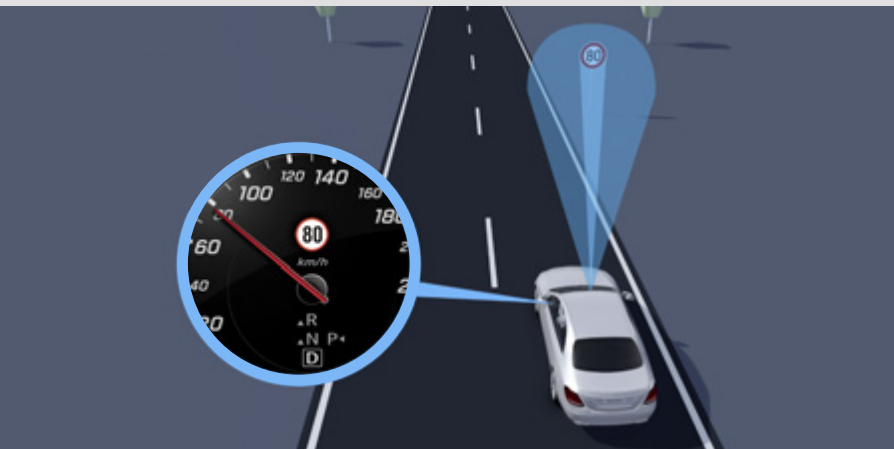

Traffic Sign Assist

To enable you to find your way in complex traffic situations, MBUX connects augmented reality for navigation in the real world. The technology incorporates graphical navigation instructions and traffic information into live images. You can get to your destination quickly, safely and stress-free.

Advanced Navigation package (code DP4) – designed and priced as a package, including items listed below.

SE, Sport and AMG Line

Total incl. VAT £495.00

Only in conjunction with Executive, Premium or Premium Plus equipment lines

Advanced Navigation package comprises:

MBUX augmented reality for navigation

A camera in the windscreen records the area in front of the vehicle. This recording runs in the media display. Superimposed highlighted information, such as house numbers and street names, facilitates orientation at the destination

Traffic Sign Assist

The camera scans the forest of speed limit signs – so navigation data holds the current valid limit at all times



> Book a test drive



> Find a Retailer



> View the Range Guide

AMG Advanced Navigation package



Head-up display

The AMG Advanced Navigation package adds the benefits of a head-up display. Important information is reflected onto the windshield, directly in the field of vision, ensuring drivers are less distracted from what is on the road ahead. Because the eyes do not have to adjust focus or make optical corrections, drivers do not become tired so quickly.

AMG Advanced Navigation package (code DP7) – designed and priced as a package, including items listed below.

Mercedes-AMG A 35 4MATIC only

Total incl. VAT £1,295.00

Only in conjunction with AMG Executive, AMG Premium or AMG Premium Plus equipment lines

AMG Advanced Navigation package comprises:

Head-up display

Your attention remains on the road because the head-up display projects key information onto the windscreen: information seems to hover two metres in front of the driver

MBUX augmented reality for navigation

A camera in the windscreen records the area in front of the vehicle. This recording runs in the media display. Superimposed highlighted information, such as house numbers and street names, facilitates orientation at the destination

Traffic Sign Assist

The camera scans the forest of speed limit signs – so navigation data holds the current valid limit at all times



Advanced Connectivity package¹



Digital vehicle key for smartphone



Wireless charging

A smarter, safer way to use your phone in your car, the Smartphone Connect package takes the things you want to do with your phone while driving and puts them on the built-in display. Make calls, send and receive messages, and listen to music, all in a way that allows you to stay focused on the road.

Advanced Connectivity package (code DP5) – designed and priced as a package, including items listed below.

All models

Total incl. VAT £495.00

Advanced Connectivity package comprises:

Smartphone integration links your mobile phone with the media system via Apple® CarPlay® and Android Auto®. This gives convenient access to the apps on your smartphone. You can also use apps from third party service providers such as Spotify

Pre-installation digital vehicle key for smartphone provides the technical basis for using your smartphone as a digital vehicle key. You can use your smartphone to open and close your car or even start the engine – even when the battery is flat

Wireless charging

Driving time becomes charging time – with just a simple hand movement your smartphone can be fixed in place in the centre console, where it is charged wirelessly

All features require a compatible mobile device and network provider. Please check www.mercedes-benz-mobile.com for details or contact your local Mercedes-Benz Retailer for further information



> Book a test drive



> Find a Retailer



> View the Range Guide

AMG Style package



More than just good looks: the AMG Style package merges the features of the AMG Aerodynamics package and the AMG Night package and combines them with matt black 19" multi-spoke alloy wheels and heat-insulating dark windows. Adding both style and an even better driving experience to your A 35 4MATIC.

AMG Style package (code DP6) – designed and priced as a package, including items listed below.

Mercedes-AMG A 35 4MATIC only

Total incl. VAT £2,595.00

AMG Style package comprises:

AMG Aerodynamics package

Developed to improve handling at high speeds and provide the basis for even greater driving enjoyment. Includes:

- AMG rear wing in high-gloss black
 - Diffuser blade in high-gloss black
 - Front apron with larger front splitter and additional flics in high-gloss black
 - Lateral airflow breakaway edges around simulated air outlets in the rear apron in high-gloss black
-

AMG Night package

Striking design features in black and high-gloss black. Painted front splitter and black chrome-plated tailpipe trim elements

19" AMG multi-spoke alloy wheels, painted matt black with a high-sheen finish

Heat-insulating dark-tinted glass

With dark tinting on rear window and rear side windows





Optional equipment

Item	Notes		SE	Sport	AMG Line	AMG A 35 4MATIC	Basic RRP excl. VAT (£)	Total RRP incl. VAT (£)
Paint, Trim and Upholstery								
Paint - designo magno matt		662	-	-	-	○	1,495.83	1,795.00
Paint - metallic		-	○	○	○	○	495.83	595.00
Seat belts - black		U17	-	-	-	○	no-cost option	
Trim - light longitudinal-grain aluminium trim		H44	-	-	○	●	100.00	120.00
Transmission and Suspension								
Suspension with Adaptive Damping system		459	-	-	-	○	579.17	695.00
Service Package								
ServiceCare ServiceCare allows you to spread the cost of servicing your new car in the Mercedes-Benz Retailer network. Taking out a ServiceCare plan ensures your servicing needs are taken care of by fully trained Mercedes-Benz Technicians with the added benefit of a Mercedes-Benz service history	Price is based on a monthly rate. Example given is for two services taken over 24 months; three services over 36 months; or four services over 48 months. Further payment options are available. New ServiceCare prices apply only to vehicles up to 12 months old prior to first service	1	○	○	○	○	24.17	29.00



> Book a test drive



> Find a Retailer



> View the Range Guide

Colours, trim and upholstery





> Book a test drive



> Find a Retailer



> View the Range Guide

Colours and materials

55

Non-metallic and metallic paints (standard and optional)

Total prices incl. VAT



149 polar white¹ **standard**



144 digital white metallic **£595.00**

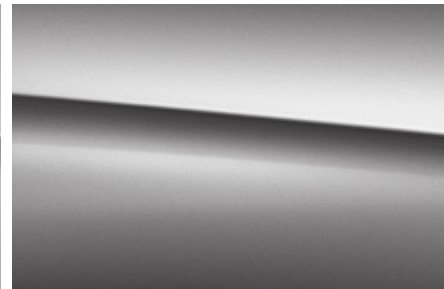

787 mountain grey metallic **£595.00**

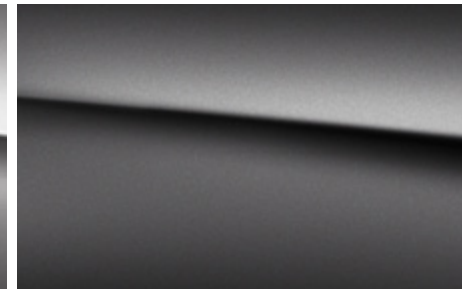

662 designo mountain grey magno² **£1,795.00**



589 jupiter red¹ **no-cost option**



775 iridium silver metallic **£595.00**

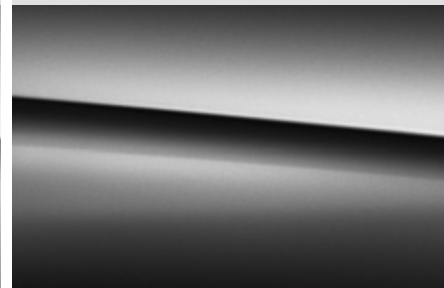

191 cosmos black metallic **£595.00**



914 sun yellow^{1,2} **no-cost option**

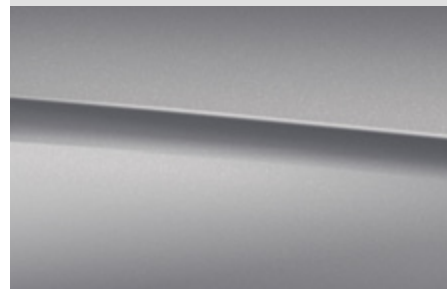

859 mojave silver metallic **£595.00**

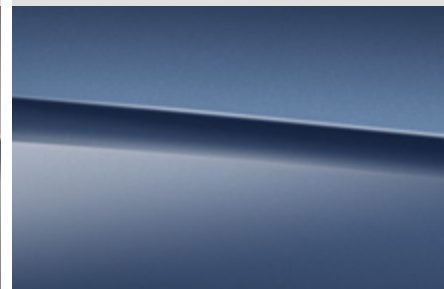

667 denim blue metallic **595.00**

¹Non-metallic paint ²Mercedes-AMG A35 4MATIC only Please note that, owing to limitations of on-screen representation, paint colours may differ from those shown



> Book a test drive



> Find a Retailer



> View the Range Guide

Trim



H55 dark carbon fibre

SE	-
Sport	●
AMG Line	-
Mercedes-AMG A35 4MATIC	-
Total RRP incl. VAT (£)	-
excl. VAT (£)	-



DINAMICA microfibre

SE	-
Sport	-
AMG Line	●
Mercedes-AMG A35 4MATIC	-
Total RRP incl. VAT (£)	-
excl. VAT (£)	-



H44 light longitudinal-grain aluminium

SE	-
Sport	-
AMG Line	○
Mercedes-AMG A35 4MATIC	●
Total RRP incl. VAT (£)	120.00
excl. VAT (£)	100.00



> Book a test drive



> Find a Retailer



> View the Range Guide

Upholstery

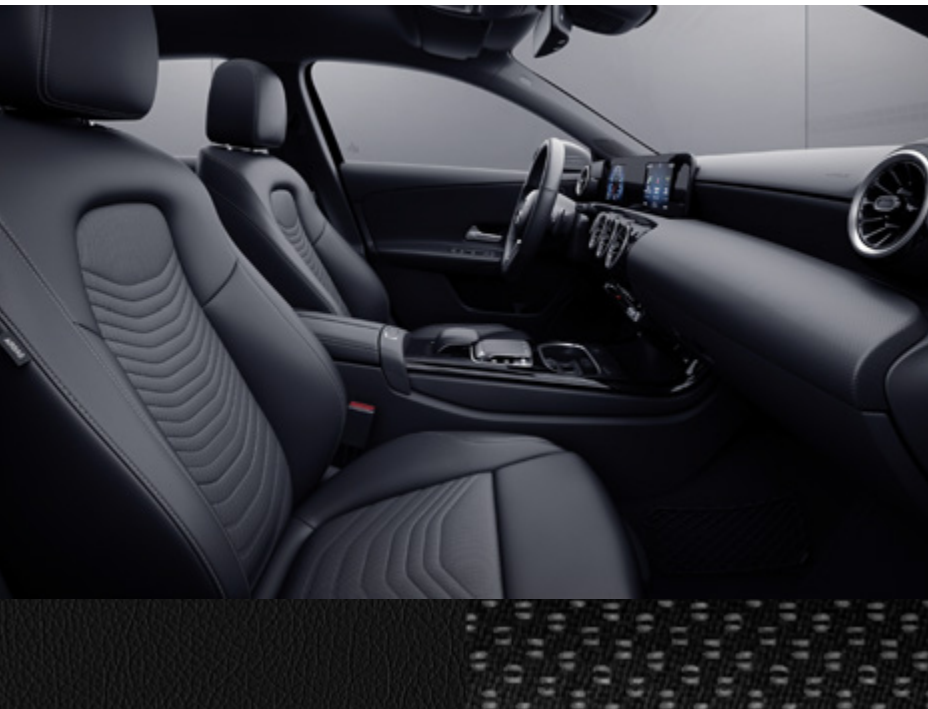

311A ARTICO man-made leather/Bertrix fabric upholstery (black)
Image shows comfort seats (code 7U2)

SE	●
Sport	-
AMG Line	-
Mercedes-AMG A 35 4MATIC	-

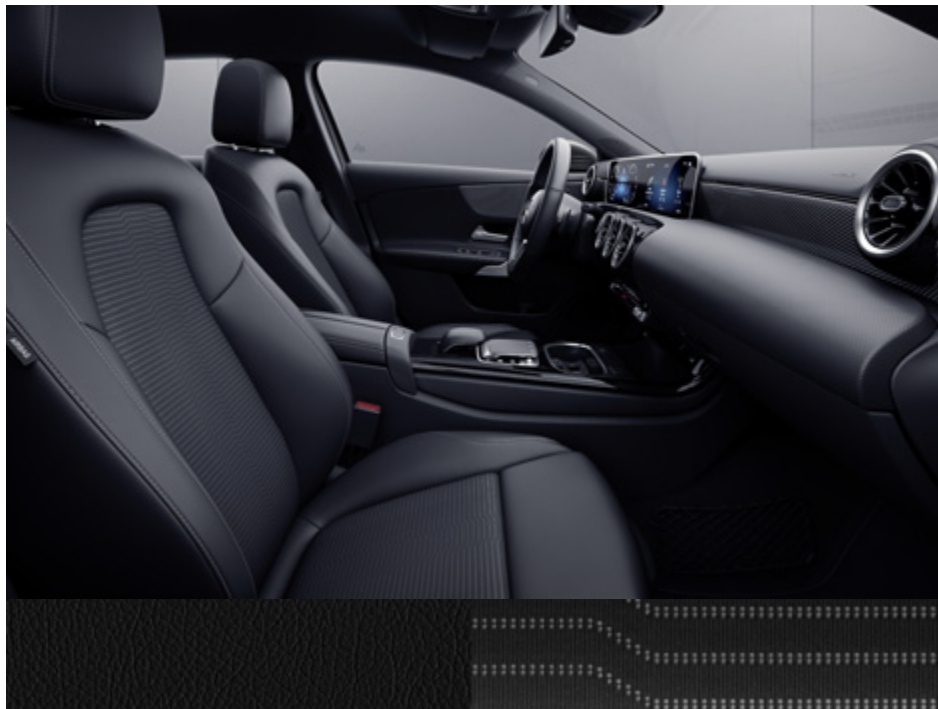

321A ARTICO man-made leather/Fléron fabric (black)
Image shows comfort seats (code 7U2)

SE	-
Sport	●
AMG Line	-
Mercedes-AMG A 35 4MATIC	-



> Book a test drive



> Find a Retailer



> View the Range Guide



651A ARTICO man-made leather/DINAMICA microfibre (black/red)
Image shows sports seats (code 7U3) with integrated headrests for Hatchback

SE	-
Sport	-
AMG Line (Hatchback)	●
Mercedes-AMG A 35 4MATIC	●



651A ARTICO man-made leather/DINAMICA microfibre (black/red)
Image shows sports seats (code 7U4) with adjustable headrests for Saloon

SE	-
Sport	-
AMG Line (Saloon)	●
Mercedes-AMG A 35 4MATIC	-



> Book a test drive



> Find a Retailer



> View the Range Guide

Leather¹ for Mercedes-AMG A 35 4MATIC - only with AMG Executive, AMG Premium or AMG Premium Plus equipment line



211A leather¹ (black)

Image shows sports seats (code 7U3) with integrated headrests for Hatchback

SE	-
Sport	-
AMG Line	-
Mercedes-AMG A 35 4MATIC	●
Standard only in conjunction with optional AMG equipment lines	



204A leather¹ (bahia brown)

Image shows sports seats (code 7U3) with integrated headrests for Hatchback

SE	-
Sport	-
AMG Line	-
Mercedes-AMG A 35 4MATIC	△
No-cost option only in conjunction with optional AMG equipment lines	



> Book a test drive



> Find a Retailer



> View the Range Guide



257A two-tone leather¹ (classic red/black)

Image shows sports seats (code 7U3) with integrated headrests for Hatchback

SE	-
Sport	-
AMG Line	-
Mercedes-AMG A 35 4MATIC	△
No-cost option only in conjunction with optional AMG equipment lines	

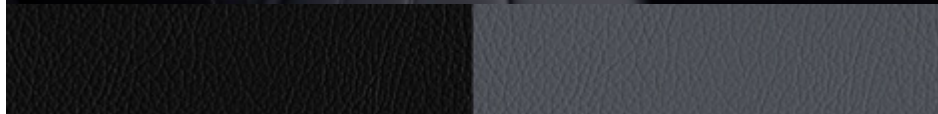

258A two-tone leather¹ (titanium grey pearl/black)

Image shows sports seats (code 7U3) with integrated headrests for Hatchback

SE	-
Sport	-
AMG Line	-
Mercedes-AMG A 35 4MATIC	△
No-cost option only in conjunction with optional AMG equipment lines	



Technical data - Hatchback

		Diesel engines		
Model		A 180 d	A 200 d	A 220 d
Engine				
Total displacement	cc	1,461	1,950	1,950
Arrangement/cylinders/valves		in-line/4/8	in-line/4/16	in-line/4/16
Power ¹	hp (kW) at rpm	116 (85)/4,000	150 (110)/3,400	190 (140)/3,800
Torque ¹	Nm at rpm	260/1,750-2,750	320/1,400 - 3,200	400/1,600 - 2,600
Transmission				
6-speed manual		-	-	-
7G-DCT 7-speed automatic		●	-	-
8G-DCT 8-speed automatic		-	●	●
		auto.		
Acceleration 0-62 mph	sec	10.5	8.1	7.0
Top speed	mph	126	137	146



Model		Diesel engines		
		A 180 d	A 200 d	A 220 d
Weights and capacities		auto.	auto.	auto.
Kerb weight	kg	1,445	1,490	1,520
Perm. Gross Vehicle Weight	kg	1,935	1,995	2,015
Boot capacity – seats up seats down		360	360	360
	l	1,200	1,200	1,200
Towing capacity – unbraked braked		720	745	750
	kg	1,400	1,600	1,600
Fuel tank capacity/of which reserve	l	43/5	43/5	43/5
Turning circle	m	11.00	11.00	11.00
Fuel consumption^{3,4,5}		auto.	auto.	auto.
Combined (consumption dependent on chosen optional equipment)	l/100 km	4.6–5.3	4.8–5.3	4.9–5.4
	mpg	61.4–53.3	58.9–53.3	57.7–52.3

³All figures are based on a standard specification with the smallest tyre size ⁴The choice of wheels and transmission may affect CO₂ emissions and corresponding Road Fund Licence

⁵The indicated values were determined according to the prescribed measurement method – Worldwide Harmonised Light Vehicle Test Procedure (WLTP). Figures shown may include options which are not available in the UK.

Figures shown are for comparability purposes; only compare with other cars tested to the same technical procedures. Figures may not reflect real life driving results, which will depend upon a number of factors including factory-fitted options, accessories fitted (post registration), variations in weather, driving styles and vehicle load. Further information about the test used to establish fuel consumption and CO₂ figures can be found at <http://www.mercedes-benz.co.uk/WLTP>

A 200 d and A 220 d Hatchback engines are RDE (Real Driving Emissions) Step 2 Certified (Euro 6d). This results in a lower VED and BIK rate as these engines will not be subject to the diesel surcharge



> Book a test drive



> Find a Retailer



> View the Range Guide

		Diesel engines		
Model		A 180 d	A 200 d	A 220 d
CO₂ emissions^{4,5,*}	g/km	auto.	auto.	auto.
Emissions standard		EU6	EU6 ⁵	EU6 ⁵
16" alloy wheels (205/60 tyres)		108	-	-
17" alloy wheels (205/55 tyres)		111	110	-
18" alloy wheels (225/45 tyres)		111	110	114
18" alloy wheels (225/45 tyres)		-	-	-
19" alloy wheels (235/35 tyres)		-	-	-

Insurance

Group rating	17-19	23-24	26-27
--------------	-------	-------	-------

Insurance ratings may vary depending on model line and specification. Please refer to <http://www.thatcham.org/abigrouprating/> for further details

³All figures are based on a standard specification with the smallest tyre size ⁴The choice of wheels and transmission may affect CO₂ emissions and corresponding Road Fund Licence

⁵The indicated values were determined according to the prescribed measurement method - Worldwide Harmonised Light Vehicle Test Procedure (WLTP). Figures shown may include options which are not available in the UK.

*CO₂ figures have been converted into NEDC-equivalent values for use with the current VED and BIK tax legislation.

Figures shown are for comparability purposes; only compare with other cars tested to the same technical procedures. Figures may not reflect real life driving results, which will depend upon a number of factors including factory-fitted options, accessories fitted (post registration), variations in weather, driving styles and vehicle load. Further information about the test used to establish fuel consumption and CO₂ figures can be found at <http://www.mercedes-benz.co.uk/WLTP>

A 200 d and A 220 d Hatchback engines are RDE (Real Driving Emissions) Step 2 Certified (Euro 6d). This results in a lower VED and BIK rate as these engines will not be subject to the diesel surcharge



		Petrol engines							
Model		A 180	A 200	A 220	A 220 4MATIC	A 250	Mercedes-AMG A 35 4MATIC		
Engine									
Total displacement	cc	1,332	1,332	1,991	1,991	1,991	1,991		
Arrangement/cylinders/valves		in-line/4/16	in-line/4/16	in-line/4/16	in-line/4/16	in-line/4/16	in-line/4/16		
Power ¹	hp (kW) at rpm	136 (100)/5,500	163 (120)/5,500	190 (140)/5,800	190 (140)/5,800	224 (165)/5,500	306 (225)/5,800		
Torque ¹	Nm at rpm	200/1,460	250/1,620	300/1,800	300/1,800	350/1,800	400/3,000–4,000		
Transmission									
6-speed manual		●	●	–	–	–	–		
7G-DCT 7-speed automatic		○	○	●	●	●	●		
8G-DCT 8-speed automatic		–	–	–	–	–	–		
Performance		man.	auto.	man.	auto.	auto.	auto.	auto.	
Acceleration 0–62 mph	sec	9.2	8.8	8.2	8.0	6.9	6.9	6.2	4.7
Top speed	mph	134	134	140	140	149	146	155 ²	155 ²



		Petrol engines							
Model		A 180	A 200	A 200	A 220	A 220 4MATIC	A 250	Mercedes-AMG A 35 4MATIC	
Weights and capacities		man.	auto.	man.	auto.	auto.	auto.	auto.	
Kerb weight	kg	1,350	1,365	1,355	1,375	1,450	1,505	1,455	1,555
Perm. Gross Vehicle Weight	kg	1,865	1,880	1,870	1,885	1,960	2,020	1,965	2,055
Boot capacity – seats up seats down		370	370	370	370	370	370	370	370
	l	1,210	1,210	1,210	1,210	1,210	1,210	1,210	1,210
Towing capacity – unbraked braked		675	680	675	685	725	750	725	750
	kg	1,400	1,400	1,600	1,600	1,600	1,800	1,600	1,800
Fuel tank capacity/of which reserve	l	43/5	43/5	43/5	43/5	43/5	51/5	43/5	51/5
Turning circle	m	11.00	11.00	11.00	11.00	11.00	11.00	11.00	11.54
Fuel consumption^{3,4,5}		man.	auto.	man.	auto.	auto.	auto.	auto.	auto.
Combined (consumption dependent on chosen optional equipment)	l/100km	6.0–6.7	5.9–6.7	6.1–6.9	5.9–6.7	6.8–7.5	7.1–7.9	6.8–7.5	7.9–8.4
	mpg	47.1–42.2	47.9–42.2	46.3–40.9	47.9–42.2	41.5–37.7	39.8–35.8	41.5–37.7	35.8–33.6

³All figures are based on a standard specification with the smallest tyre size ⁴The choice of wheels and transmission may affect CO₂ emissions and corresponding Road Fund Licence

⁵The indicated values were determined according to the prescribed measurement method – Worldwide Harmonised Light Vehicle Test Procedure (WLTP). Figures shown may include options which are not available in the UK.

Figures shown are for comparability purposes; only compare with other cars tested to the same technical procedures. Figures may not reflect real life driving results, which will depend upon a number of factors including factory-fitted options, accessories fitted (post registration), variations in weather, driving styles and vehicle load. Further information about the test used to establish fuel consumption and CO₂ figures can be found at <http://www.mercedes-benz.co.uk/WLTP>



		Petrol engines											
Model		A 180		A 200		A 220		A 220 4MATIC		A 250		Mercedes-AMG A 35 4MATIC	
CO₂ emissions^{4,5,*}	g/km	man.	auto.	man.	auto.	auto.	auto.	auto.	auto.	auto.	auto.	auto.	auto.
Emissions standard		EU6	EU6	EU6	EU6	EU6	EU6	EU6	EU6	EU6	EU6	EU6	EU6
16" alloy wheels (205/60 tyres)		127	119	-	-	-	-	-	-	-	-	-	-
17" alloy wheels (205/55 tyres)		129	122	136	123	-	-	-	-	-	-	-	-
18" alloy wheels (225/45 tyres)		129	122	136	123	141	148	148	148	141	141	-	-
18" alloy wheels (225/45 tyres)		-	-	-	-	-	-	-	-	-	-	-	167
19" alloy wheels (235/35 tyres)		-	-	-	-	-	-	-	-	-	-	-	169

Insurance

Group rating	19-21	19-21	23-24	23-24	27-28	28-29	29-31	37E
--------------	-------	-------	-------	-------	-------	-------	-------	-----

Insurance ratings may vary depending on model line and specification. Please refer to <http://www.thatcham.org/abigrouprating/> for further details

⁴The choice of wheels and transmission may affect CO₂ emissions and corresponding Road Fund Licence

⁵The indicated values were determined according to the prescribed measurement method - Worldwide Harmonised Light Vehicle Test Procedure (WLTP). Figures shown may include options which are not available in the UK.

*CO₂ figures have been converted into NEDC-equivalent values for use with the current VED and BIK tax legislation.

Figures shown are for comparability purposes; only compare with other cars tested to the same technical procedures. Figures may not reflect real life driving results, which will depend upon a number of factors including factory-fitted options, accessories fitted (post registration), variations in weather, driving styles and vehicle load. Further information about the test used to establish fuel consumption and CO₂ figures can be found at <http://www.mercedes-benz.co.uk/WLTP>



> Book a test drive



> Find a Retailer



> View the Range Guide

SE, Sport and AMG Line*

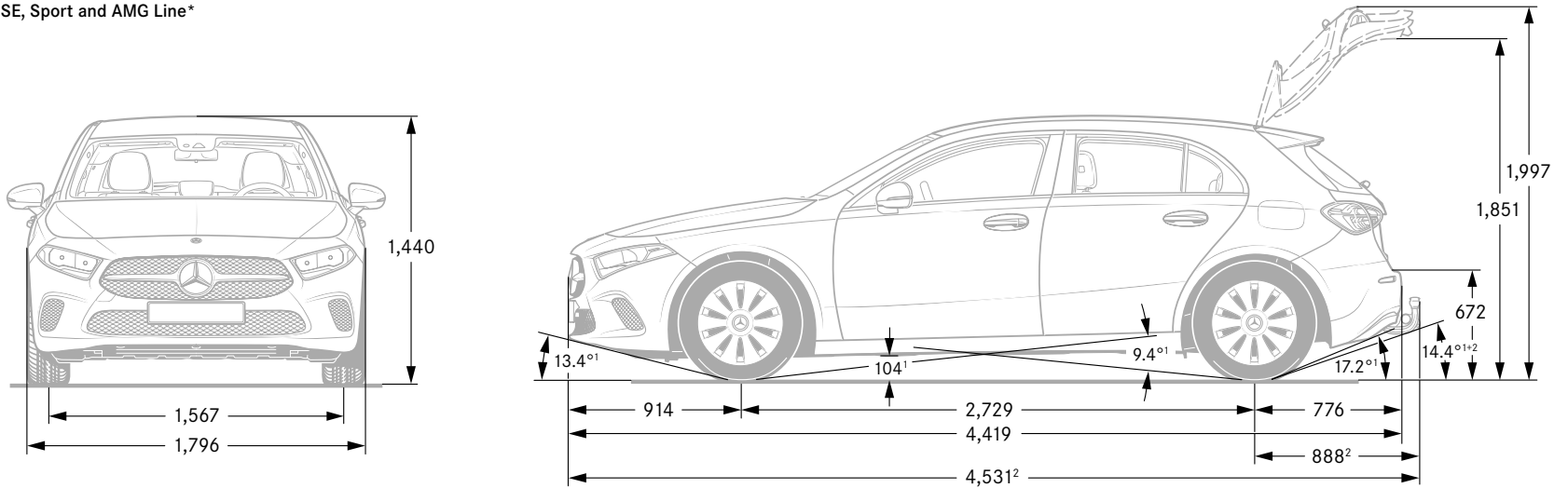

¹At Permissible Gross Vehicle Weight ²With tow bar (optional extra) *Mercedes-AMG A 35 4MATIC features wider wheel arches for AMG wheels
 All measurements in millimetres. The dimensions shown are mean values and apply to standard-specification, unladen vehicles
 The figures on pages 61-67 are correct at time of publication. Please refer to the government website for latest data - <http://carfueldata.direct.gov.uk/>



Technical data - Saloon

Model	Diesel engine		Petrol engines		
	A 180 d		A 200	A 220 4MATIC	A 250
Engine					
Total displacement	cc	1,461	1,332	1,991	1,991
Arrangement/cylinders/valves		in-line/4/8	in-line/4/16	in-line/4/16	in-line/4/16
Power ¹	hp (kW) at rpm	116 (85)/4,000	163 (120)/5,500	190 (140)/5,800	224 (165)/5,800
Torque ¹	Nm at rpm	260/1,750-2,750	250/1,620	300/1,600	350/1,800
Transmission					
6-speed manual		-	●	-	-
7G-DCT 7-speed automatic		●	○	●	●
Performance					
		auto.	man.	auto.	auto.
Acceleration 0-62 mph	sec	10.6	8.3	8.1	7.0
Top speed	mph	128	143	143	147
					155 ²



Model	Diesel engine		Petrol engines			
	A 180 d		A 200	A 220 4MATIC	A 250	
Weights and capacities		auto.	man.	auto.	auto.	auto.
Kerb weight	kg	1,455	1,365	1,385	1,520	1,465
Perm. Gross Vehicle Weight	kg	1,965	1,900	1,915	2,050	1,995
Boot capacity – seats up		–	–	–	–	–
seats down	l	410	420	420	420	420
Towing capacity – unbraked		725	680	690	750	730
braked	kg	1,400	1,600	1,600	1,800	1,600
Fuel tank capacity/of which reserve	l	43/5	43/5	43/5	51/5	43/5
Turning circle	m	11.00	11.00	11.00	11.00	11.00
Fuel consumption^{3,4,5}		auto.	man.	auto.	auto.	auto.
Combined (consumption dependent on chosen optional equipment)	l/100 km mpg	4.5–5.3 62.8–53.3	6.0–6.8 47.1–41.5	5.9–6.6 47.9–42.8	6.9–7.8 40.9–36.2	6.7–7.4 42.2–38.2

³All figures are based on a standard specification with the smallest tyre size ⁴The choice of wheels and transmission may affect CO₂ emissions and corresponding Road Fund Licence

⁵The indicated values were determined according to the prescribed measurement method – Worldwide Harmonised Light Vehicle Test Procedure (WLTP). Figures shown may include options which are not available in the UK.

Figures shown are for comparability purposes; only compare with other cars tested to the same technical procedures. Figures may not reflect real life driving results, which will depend upon a number of factors including factory-fitted options, accessories fitted (post registration), variations in weather, driving styles and vehicle load. Further information about the test used to establish fuel consumption and CO₂ figures can be found at <http://www.mercedes-benz.co.uk/WLTP>



Model	Diesel engine		Petrol engines			
	A 180 d	A 200	A 220 4MATIC	A 250		
CO₂ emissions ^{4,5,*}	g/km	auto.	man.	auto.	auto.	auto.
Emissions standard		EU6	EU6	EU6	EU6	EU6
17" alloy wheels (205/55 tyres)		110	134	121	-	-
18" alloy wheels (225/45 tyres)		110	134	121	149	139

Insurance

Group rating: base model	18-19	23-24	23-24	tba	tba
--------------------------	-------	-------	-------	-----	-----

Insurance ratings may vary depending on model line and specification. Please refer to <http://www.thatcham.org/abigrouprating/> for further details

³All figures are based on a standard specification with the smallest tyre size ⁴The choice of wheels and transmission may affect CO₂ emissions and corresponding Road Fund Licence

⁵The indicated values were determined according to the prescribed measurement method - Worldwide Harmonised Light Vehicle Test Procedure (WLTP). Figures shown may include options which are not available in the UK.

*CO₂ figures have been converted into NEDC-equivalent values for use with the current VED and BIK tax legislation.

Figures shown are for comparability purposes; only compare with other cars tested to the same technical procedures. Figures may not reflect real life driving results, which will depend upon a number of factors including factory-fitted options, accessories fitted (post registration), variations in weather, driving styles and vehicle load. Further information about the test used to establish fuel consumption and CO₂ figures can be found at <http://www.mercedes-benz.co.uk/WLTP>



Sport and AMG Line

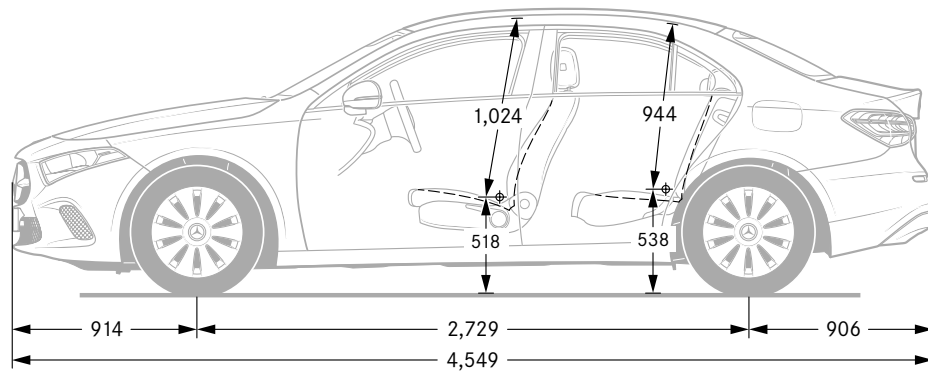
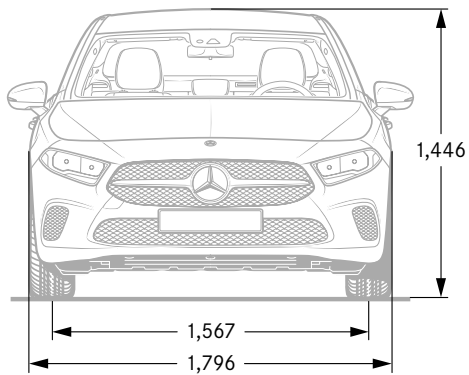



> Book a test drive



> Find a Retailer



> View the Range Guide

Road Fund Licence



All road vehicle registrations are subject to Vehicle Excise Duty (Road Fund Licence), which varies in accordance with the vehicle's CO₂ emissions. A first year rate for each taxation band will apply. The table below shows the bands (A–M) created by the DVLA and the corresponding Road Fund Licence. CO₂ emissions are listed in the technical data on pages 63 and 70, and the relevant Excise Duty is reflected in the on-the-road prices on pages 11–13.

Band	CO ₂ emissions (g/km)	First year rate petrol (£)	First year rate diesel (£) ¹	First year rate alt. fuel (£)	Standard rate (£)	Premium rate (£) ²
A	0	0.00	0.00	0.00	0.00	310.00
B	1 to 50	10.00	25.00	0.00	140.00	450.00
C	51 to 75	25.00	110.00	15.00	140.00	450.00
D	76 to 90	110.00	130.00	100.00	140.00	450.00
E	91 to 100	130.00	150.00	120.00	140.00	450.00
F	101 to 110	150.00	170.00	140.00	140.00	450.00
G	111 to 130	170.00	210.00	180.00	140.00	450.00
H	131 to 150	210.00	530.00	200.00	140.00	450.00
I	151 to 170	530.00	855.00	520.00	140.00	450.00
J	171 to 190	855.00	1,280.00	845.00	140.00	450.00
K	191 to 225	1,280.00	1,815.00	1,270.00	140.00	450.00
L	226 to 255	1,815.00	2,135.00	1,805.00	140.00	450.00
M	over 255	2,135.00	2,135.00	2,125.00	140.00	450.00

Some of the model features, optional extras and colours shown may not be available, or may only be available in a different specification

¹Applies to all Mercedes-Benz diesel models which do not comply with RDE (Real Driving Emissions) Step 2 Certified (Euro 6d)

²Premium rate only applicable to vehicles where the list price is over £40,000 including any factory-fitted options, standard UK delivery charge, number plates, fuel and VAT



> Book a test drive



> Find a Retailer



> View the Range Guide

Services and insurance

Mercedes-Benz ServiceCare

We believe that servicing costs should be as flexible and affordable as possible for your A-Class, which is why we offer ServiceCare, an easy way to budget for all your servicing costs. It spreads your bills into manageable payments based on whether you have a new or used Mercedes-Benz.

With ServiceCare we guarantee the price of parts and labour for up to four services and safeguard against any further inflation. It also covers the cost of any additional items including brake fluid, spark plugs, air filters, fuel filters and screen wash.

You can choose either to add your servicing costs into your monthly spend or pay the full amount in a one-off payment, giving you peace of mind that they are taken care of for the period of the plan.

To receive a personalised ServiceCare plan recommendation visit the ServiceCare Calculator at servicecarerates.mercedes-benz.co.uk

Warranty and breakdown cover

Every Mercedes-Benz comes with a three-year unlimited mileage warranty against manufacturing or material defects¹ and up to 30 years warranty against perforation due to corrosion from the inside out.² What's more, it's also covered by Mercedes-Benz Roadside Assistance – a unique package comprising up to 30 years pan-European breakdown assistance.²

Insurance

Since our name is synonymous with reliability, who better to trust with your motor insurance? Mercedes-Benz Insurance provides a motor insurance policy specifically designed to give you the cover you would expect from Mercedes-Benz. For a motor insurance quotation, call **0345 600 2180**.*



> Book a test drive



> Find a Retailer



> View the Range Guide

Mercedes me connect

Mercedes me connect enables you to connect to your car via desktop, tablet or smartphone via an app. It provides access to services that enhance your Mercedes-Benz experience and fit effortlessly into your daily digital routine.¹

Standard Services.

Available on all models, except G-Class.

- **Emergency Call** – if there's an accident, this feature automatically shares your vehicle location and status for a fast response from the emergency services
- **Accident & Breakdown Management** – contact our Customer Assistance Centre with a single button for fast breakdown recovery
- **Telediagnosics** – automatically detects and shares details of any vehicle wear and tear with you, and shares the data with your Retailer
- **Maintenance Management** – reminds you when your service is due and automatically shares maintenance data with your Retailer
- **Parking Time Assist** – track the time on your parking meter and receive an alert when it's due to expire

¹Currently unavailable in the Channel Islands and the Isle of Man





> Book a test drive



> Find a Retailer



> View the Range Guide

Mercedes me connect

75

Vehicle Setup.

Visit the Mercedes me connect store or app for pricing.

- **Personal Profile** – store your preferences, such as your favourite radio stations and apps, to create your personal driver profile
- **Maintenance (Vehicle Status)** – check safety information, such as coolant level and brake pad condition, so you can be sure your car is safe and ready to drive
- **Remote Door Unlock** – lock and unlock your car remotely, wherever you are in the world
- **Send to Car Function** – search for destinations on your smartphone, tablet or desktop, then send the routes direct to your car for navigation

Vehicle Monitoring.

Visit the Mercedes me connect store or app for pricing.

- **Geo-fencing** – set up a geographical boundary and receive alerts whenever your car enters or leaves this area
- **Parked Vehicle Locator** – locate your parked car when within 1 mile and plot a route back to it
- **Vehicle Tracker** – track the location of your car anywhere in the world

Visit the Mercedes me connect store for more information:

shop.mercedes-benz.com/en-gb/connect



Mercedes-Benz Finance

Why should you finance with Mercedes-Benz?

At Mercedes-Benz we believe a great driving experience should be matched by an equally great ownership experience. That is why we put just as much thought, time and effort into designing our finance options, our service plans and our insurance cover as we do into our vehicles.

We are not in the business of simply providing a loan to fund the purchase of your dream vehicle. We look on it as a journey that we take with you, from the moment you choose your new Mercedes-Benz, to helping you in choosing your next one.

If you would like to find out more about any of our current offers, simply call into your local Mercedes-Benz Retailer where one of our Business Managers will be more than happy to talk you through anything you need to know.

Helping you find the right solution.

You should find our finance packages are more convenient than a traditional personal loan because:

- Funds are immediately available – no waiting for cheques or loans to clear.
- There is no security required – either against your home or other assets.
- We have clear and transparent rates – the APR we quote is the APR you get.
- We have friendly Business Managers – experts in vehicle finance who can talk you through all of your plans in detail.

One of our most popular finance products is Mercedes-Benz Agility (our Personal Contract Purchase product). We also offer Contract Hire, Operating Lease and Hire Purchase solutions. If you would like to find out more about these speak to your Retailer or visit www.mercedes-benz.co.uk/fandi.

Mercedes-Benz Agility (our PCP product).

At the start of an Agility agreement, you put down a deposit and decide the term of your agreement and your annual mileage. You will be advised of the Guaranteed Future Value, which offers you the reassurance of knowing exactly what you will need to pay to own the vehicle outright in the future (this is known as the Optional Purchase Payment).

Throughout your agreement you simply pay your agreed monthly payments and when the agreement comes to an end you either purchase, hand back or part-exchange your vehicle.





Agility features:

- Fixed regular payments mean you can easily budget.
- Payments are based only on a proportion of the vehicle's value, keeping your monthly payments lower.
- Our Guaranteed Future Value avoids the risk of unplanned depreciation of your vehicle.
- You defer your ownership decision until the end of the agreement.

At the end of your agreement you have three options to choose from.

Option 1: Purchase your Mercedes-Benz.

Purchase your Mercedes-Benz by paying the Optional Purchase Payment and Purchase Activation Fee.¹ This will complete the purchase of your Mercedes-Benz, leaving you free to simply enjoy your vehicle.

Option 2: Hand back your Mercedes-Benz.

If you decide to return your vehicle to us, it must be in line with our Vehicle Return Standards,^{*} as vehicle condition, excess mileage and other charges may be payable.

Option 3: Part-Exchange for a new vehicle.

Purchase your Mercedes-Benz by paying the Optional Purchase Payment and Purchase Activation Fee.¹ This will complete the purchase of your Mercedes-Benz, leaving you free to part-exchange for a new vehicle.

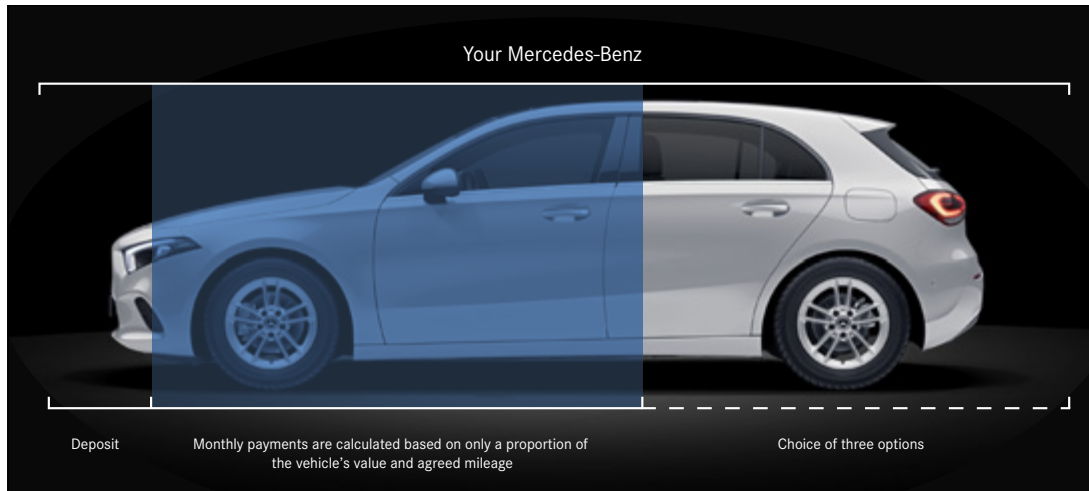

¹Please note the 'Purchase Activation Fee' of £10 will be debited from your account *To find out more information about our Vehicle Return Standards please visit <http://mercedes-benz.co.uk/vrs>



> Book a test drive





> Find a Retailer





> View the Range Guide

Follow us on the following social media channels:

 facebook.com/mercedesbenzuk

 twitter.com/mercedesbenzuk

 youtube.com/mercedesbenzuk

 instagram.com/mercedesbenzuk

Effective from January 2019 Production. Information correct at time of publication.

Prices and specifications are subject to change without prior notice.

MBW177PL/0319 MY809.5

Mercedes-Benz Cars UK Limited, Tongwell, Milton Keynes, MK15 8BA. Company number 2448457 www.mercedes-benz.co.uk