



# The GLE Coupé

Effective from January 2022 Production.

Mercedes-Benz







Book a test drive



Buy your GLE Coupé



Find a Retailer



Some of the model features, optional extras and colours shown may not be available, or may only be available in a different specification, or at a different price.

Design	Technology	Plug-In Hybrid	AMG Line Premium Plus	Model prices	Mercedes-AMG	Mercedes-AMG prices	Mercedes-AMG upholstery	Personalisation	Standard equipment	Genuine accessories	Technical data	Additional information
--------	------------	----------------	-----------------------	--------------	--------------	---------------------	-------------------------	-----------------	--------------------	---------------------	----------------	------------------------



[Book a test drive](#)[Buy your GLE Coupé](#)[Find a Retailer](#)

Some of the model features, optional extras and colours shown may not be available, or may only be available in a different specification, or at a different price.

<a href="#">Design</a>	<a href="#">Technology</a>	<a href="#">Plug-In Hybrid</a>	<a href="#">AMG Line Premium Plus</a>	<a href="#">Model prices</a>	<a href="#">Mercedes-AMG</a>	<a href="#">Mercedes-AMG prices</a>	<a href="#">Mercedes-AMG upholstery</a>	<a href="#">Personalisation</a>	<a href="#">Standard equipment</a>	<a href="#">Genuine accessories</a>	<a href="#">Technical data</a>	<a href="#">Additional information</a>
------------------------	----------------------------	--------------------------------	---------------------------------------	------------------------------	------------------------------	-------------------------------------	---	---------------------------------	------------------------------------	-------------------------------------	--------------------------------	--





Book a test drive



Buy your GLE Coupé



Find a Retailer



Some of the model features, optional extras and colours shown may not be available, or may only be available in a different specification, or at a different price.

Design	Technology	Plug-In Hybrid	AMG Line Premium Plus	Model prices	Mercedes-AMG	Mercedes-AMG prices	Mercedes-AMG upholstery	Personalisation	Standard equipment	Genuine accessories	Technical data	Additional information
--------	------------	----------------	-----------------------	--------------	--------------	---------------------	-------------------------	-----------------	--------------------	---------------------	----------------	------------------------



[Book a test drive](#)[Buy your GLE Coupé](#)[Find a Retailer](#)

Some of the model features, optional extras and colours shown may not be available, or may only be available in a different specification, or at a different price.

<a href="#">Design</a>	<a href="#">Technology</a>	<a href="#">Plug-In Hybrid</a>	<a href="#">AMG Line Premium Plus</a>	<a href="#">Model prices</a>	<a href="#">Mercedes-AMG</a>	<a href="#">Mercedes-AMG prices</a>	<a href="#">Mercedes-AMG upholstery</a>	<a href="#">Personalisation</a>	<a href="#">Standard equipment</a>	<a href="#">Genuine accessories</a>	<a href="#">Technical data</a>	<a href="#">Additional information</a>
------------------------	----------------------------	--------------------------------	---------------------------------------	------------------------------	------------------------------	-------------------------------------	---	---------------------------------	------------------------------------	-------------------------------------	--------------------------------	--





Book a test drive



Buy your GLE Coupé



Find a Retailer



Some of the model features, optional extras and colours shown may not be available, or may only be available in a different specification, or at a different price.

Design	Technology	Plug-In Hybrid	AMG Line Premium Plus	Model prices	Mercedes-AMG	Mercedes-AMG prices	Mercedes-AMG upholstery	Personalisation	Standard equipment	Genuine accessories	Technical data	Additional information
--------	------------	----------------	-----------------------	--------------	--------------	---------------------	-------------------------	-----------------	--------------------	---------------------	----------------	------------------------





# GLE Technology

<a href="#">Design</a>	<b>Technology</b>	<a href="#">Plug-In Hybrid</a>	<a href="#">AMG Line Premium Plus</a>	<a href="#">Model prices</a>	<a href="#">Mercedes-AMG</a>	<a href="#">Mercedes-AMG prices</a>	<a href="#">Mercedes-AMG upholstery</a>	<a href="#">Personalisation</a>	<a href="#">Standard equipment</a>	<a href="#">Genuine accessories</a>	<a href="#">Technical data</a>	<a href="#">Additional information</a>
------------------------	-------------------	--------------------------------	---------------------------------------	------------------------------	------------------------------	-------------------------------------	---	---------------------------------	------------------------------------	-------------------------------------	--------------------------------	--





Book a test drive



Buy your GLE Coupé



Find a Retailer

# Mercedes-Benz User Experience (MBUX)

Transforming the in-car user experience, thanks to MBUX: Controlled via voice or touch input, the innovative infotainment system can over time even predict personal habits thanks to artificial intelligence.



Using the touchpad you can control the display of the multimedia system



Multi-gesture touchpad control

## Voice control

- Activated by the keywords “Hey Mercedes”, the new intelligent voice control LINGUATRONIC<sup>1</sup> lets you control many of the infotainment functions, including destination input, phone calls or music selection
- MBUX is able to understand different accents and will adjust to you over time
- MBUX even understands indirect commands. Feeling chilly? Just say “I feel cold” and MBUX will adjust the temperature for you

## Personalisation

- Turn the new GLE into your very own Mercedes-Benz by personalising driving modes, radio stations and much more
- Your personal settings can be saved in up to seven different profiles, making your driving experience the best one possible
- Thanks to artificial intelligence, MBUX is able to learn and adapt over time. It will be able to predict your personal habits, such as navigation for frequently-driven routes, or the radio station you like to listen to on your way home from work

## Touch inputs

- Beside voice control you can operate MBUX via touchscreen, the touchpad on the centre console, as well as touch control buttons on the steering wheel
- The touchpad recognises your handwriting should you wish to enter addresses or phone numbers silently

## Maintenance and service

- Wondering when the next service is due? Or how much further you can drive until you need to stop at a petrol station? Just ask your MBUX – it will tell you the answer

<sup>1</sup>LINGUATRONIC off-board functions are currently only available for three years

Design	Technology	Plug-In Hybrid	AMG Line Premium Plus	Model prices	Mercedes-AMG	Mercedes-AMG prices	Mercedes-AMG upholstery	Personalisation	Standard equipment	Genuine accessories	Technical data	Additional information
--------	------------	----------------	-----------------------	--------------	--------------	---------------------	-------------------------	-----------------	--------------------	---------------------	----------------	------------------------



# Mercedes me connect

Stay connected any time, anywhere.

# Mercedes me

Mercedes me is a range of innovative online services designed to enhance your Mercedes-Benz experience. Accessible via mobile, tablet or PC, Mercedes me lets you enjoy the highest standards of care and support, in a way that integrates seamlessly with your busy lifestyle.

### Safety and Service – Mercedes me connect helps to keep you and your car safe

Check your car's oil level, tyre pressure and fuel from your phone so you'll be ready for every journey.

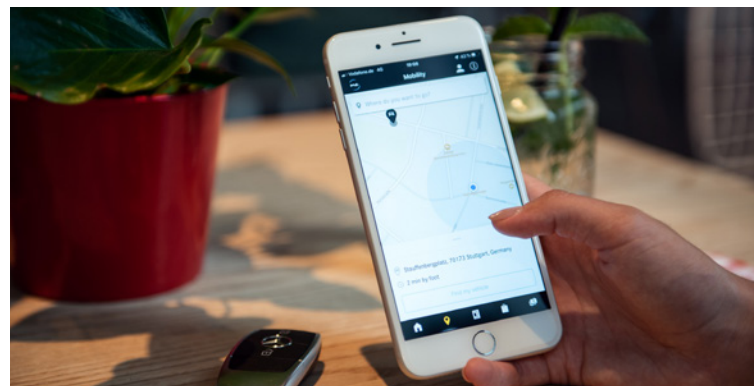

### Infotainment – Online and Entertainment services from Mercedes me connect

Love music? Get a 3-month free subscription to Tidal when you connect your car.

### Live Traffic Information, Parked Vehicle Locator and much more with Mercedes me connect

Forgot where you've parked? Parked Vehicle Locator<sup>1</sup> will show you exactly where your car is as long as you're in a 1-mile radius of where you parked. Real-time traffic data and dynamic route with shorter journey times.

For more information speak to your local Retailer or visit the Mercedes me connect store at [shop.mercedes-benz.com/en-gb/connect](http://shop.mercedes-benz.com/en-gb/connect)

### Comfort – connect to your car anytime, anywhere

Forgot to lock your car? With Remote Car Lock<sup>2</sup> you will receive a notification on your smartphone to let you know. With one tap, you can lock and unlock your vehicle so you never have to worry.

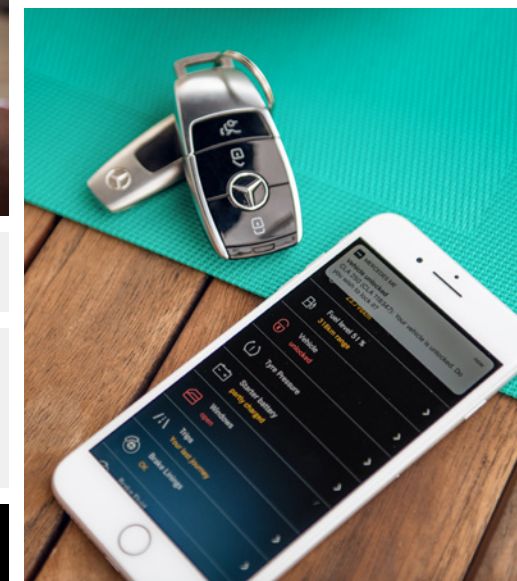

<sup>1</sup>Available on all models with the Vehicle Monitoring package. This option may vary between standard and additional cost dependent on the model

<sup>2</sup>Part of the Vehicle Status package. This option may vary between standard and additional cost dependent on the model

Images shown are for illustration purposes only

Design	Technology	Plug-In Hybrid	AMG Line Premium Plus	Model prices	Mercedes-AMG	Mercedes-AMG prices	Mercedes-AMG upholstery	Personalisation	Standard equipment	Genuine accessories	Technical data	Additional information
--------	------------	----------------	-----------------------	--------------	--------------	---------------------	-------------------------	-----------------	--------------------	---------------------	----------------	------------------------

[Book a test drive](#)[Buy your GLE Coupé](#)[Find a Retailer](#)

# Driving Assistance packages

**The Driving Assistance package** contains a range of highly intelligent features to help you stay safe on the road – by making the drive more effortless, by warning of danger, and by taking steps to protect you in an emergency. This package is standard for AMG Line Premium Plus and Mercedes-AMG GLE 53 4MATIC+ Premium Plus.

**Active Blind Spot Assist** can warn the driver of vehicles in the blind spot during a lane change and can help to avoid a collision by means of one-sided braking intervention

**Active Braking Assist with cross-traffic function** can help to avoid accidents with vehicles ahead, crossing traffic and also pedestrians, and/or mitigate their consequences

**Active Distance Assist DISTRONIC** helps maintain the desired distance from the vehicle in front

**Active Emergency Stop Assist:** immediate emergency braking if evasion is impossible

**Active Lane Keeping Assist**

**Active Speed Limit Assist** ensures detected speed limits are automatically adopted as the set speed for Active Distance Assist DISTRONIC

**Active Steering Assist:** targeted steering intervention to prevent unintentional drifting out of lane

**Evasive Steering Assist** can support the driver in making evasive manoeuvres if, in a dangerous situation, he/she moves to avoid any pedestrian detected by the system

**Pedestrian warning function near pedestrian crossings**

**PRE-SAFE® PLUS:** when a rear-end collision threatens, it can initiate preventive measures, including warning following traffic and locking the brakes on standstill

**Route-based speed adjustment:** adaption of speed before curves, roundabouts and junctions

**Traffic Sign Assist**

**The Driving Assistance Plus package** contains a few more safety features. Standard on Mercedes-AMG GLE 63 S 4MATIC+.

**Active Stop-and-Go Assist**

**PRE-SAFE® impulse** side moves occupants away from doors just before an imminent side impact

Active Steering Assist



Active Distance Assist DISTRONIC



Design	Technology	Plug-In Hybrid	AMG Line Premium Plus	Model prices	Mercedes-AMG	Mercedes-AMG prices	Mercedes-AMG upholstery	Personalisation	Standard equipment	Genuine accessories	Technical data	Additional information
--------	------------	----------------	-----------------------	--------------	--------------	---------------------	-------------------------	-----------------	--------------------	---------------------	----------------	------------------------





Book a test drive



Buy your GLE Coupé



Find a Retailer



GLE

# Plug-In Hybrid

<a href="#">Design</a>	<a href="#">Technology</a>	<a href="#">Plug-In Hybrid</a>	<a href="#">AMG Line Premium Plus</a>	<a href="#">Model prices</a>	<a href="#">Mercedes-AMG</a>	<a href="#">Mercedes-AMG prices</a>	<a href="#">Mercedes-AMG upholstery</a>	<a href="#">Personalisation</a>	<a href="#">Standard equipment</a>	<a href="#">Genuine accessories</a>	<a href="#">Technical data</a>	<a href="#">Additional information</a>
------------------------	----------------------------	--------------------------------	---------------------------------------	------------------------------	------------------------------	-------------------------------------	---	---------------------------------	------------------------------------	-------------------------------------	--------------------------------	--

# Plug-in Hybrid Electric Vehicle (PHEV) Benefits of driving a plug-in hybrid.

Our plug-in hybrids feature either a petrol or diesel powertrain, combined with a High Voltage battery and electric motor. Enjoy hybrid mode for maximum efficiency, or all-electric mode for local emission-free driving.

## Lower running costs

Did you know that electric cars could cost up to a third less than a diesel or petrol car to run, as well as being cheaper to maintain? We've partnered with Go Ultra Low, a joint Government and car industry campaign, to give you unbiased advice on making the switch to an electric car. Use Go Ultra Low's cost saving calculator to see how much you can save.<sup>1</sup>

[› Discover more](#)

## Lower road fund license

Plug-in hybrid vehicles have lower emissions – this means you pay less for road tax.

## Cleaner vehicle discount

Plug-in hybrid models qualify for the 100% cleaner vehicle discount within the London Congestion Charge zone.

## Business benefits

With 100% first-year capital allowances<sup>2</sup> and lower Company Car tax, electric cars offer significant benefits to businesses and employees.

[› Click here for more information](#)

<sup>1</sup>Please note that by clicking below you will be directed to the Go Ultra website <sup>2</sup>100% first-year capital allowances only apply to vehicles less than 50 g CO<sub>2</sub>/km



[Book a test drive](#)[Buy your GLE Coupé](#)[Find a Retailer](#)

# Plug-in Hybrid Electric Vehicle (PHEV) The GLE 350 de.

Plug-in hybrid vehicles enjoy the same functionality of full Hybrid technology, with the added benefit that they can be charged from an external electricity source.

## GLE 350 de 4MATIC

Diesel – 1,950 cc, 4-cylinder, 194 hp/143 kW

Electric motor – 136 hp/100kW

**Available as:** AMG Line Premium Plus

**OTR from £76,080<sup>1</sup>**



### Standard equipment

Charging cable – Mode 3 cable (8 metres, straight), for wallbox and public charging stations

Charging socket

Charging system – AC charging system rated at 7.4 kW (Three Phase)

Pre-entry climate control

Radar-based recuperation

Remote and Charging Services Plus

### Technical details

Equivalent All-Electric Range (EAER) <sup>2</sup>	54 miles
AC charging time, 10–100% <sup>3</sup>	
At a domestic socket <sup>4</sup>	11 hrs 30 mins
At a wallbox (3.7 kW AC Single Phase)	6 hrs 45 mins
At a charging station (7.4 kW AC Three Phase)	3 hrs 30 mins
DC charging time, 10–80% (60 kW)	20 mins
Range power consumption, combined <sup>2,5</sup>	29.7–29.4 kWh/100 km
Battery type (usable)	lithium-ion (31.0 kWh)
Capacity on-board charger	3.7 kW (AC Single Phase)/7.4 kW (AC Three Phase)/60 kW (DC)

<sup>1</sup>The recommended on-the-road price includes the Road Fund Licence applicable to the standard model plus delivery charge (£730.00 incl. VAT), new vehicle registration fee (£55.00), fuel (£50.00 incl. VAT), and number plates (£25.00 incl. VAT). VAT is calculated at the standard rate of 20%. Some of the model features, optional extras and colours shown may not be available, or may only be available in a different specification, or at a different price

<sup>2</sup>The indicated values were determined according to the prescribed measurement method - Worldwide Harmonised Light Vehicle Test Procedure (WLTP). Figures shown may include options which are not available in the UK. For Plug-in Hybrid Electric Vehicle (PHEV) figures determined with the battery fully charged, using a combination of both battery power and fuel. These models require mains electricity for charging

<sup>3</sup>Specified voltage and current values refer to network infrastructure and can be limited by the vehicle. Times are from 10-100% charge using a wallbox (three-phase) or standard socket (single-phase)

<sup>4</sup>If you are planning to charge your Mercedes-Benz plug-in electric vehicle using a 3-pin domestic plug socket you must get a qualified electrician to inspect and sign off the socket to confirm it is safe and suitable to charge your vehicle. Do not use an electric vehicle 3-pin charge cable with an extension cord

<sup>5</sup>The certified electrical consumption is generally determined at maximum AC charging capacity using a Mode 3 cable. It is therefore recommended that vehicles with a HV battery preferably be charged at a wallbox or an AC charging station with a Mode 3 cable in order to achieve shorter charging times and improved charging efficiency



Book a test drive



Buy your GLE Coupé



Find a Retailer

# Home charging Simple, convenient, fast charging.



Mercedes-Benz plug-in vehicle customers with off-street parking can benefit from the convenience and speed of charging at home by installing a home charger. The 7kW home chargers deliver a full charge in under seven hours.

**Home charger 7 kW: £875\* incl. VAT & installation**

### Key benefits of the 7kW home charger:

Robust and weatherproof, for indoor or outdoor use, and comes with a three year warranty. Keep track of your charging using your chosen providers' app – available on both the App Store and the Google Play Store.

### OZEV Grant:

You may be entitled to claim for an OZEV grant towards the cost of your home charger.<sup>1</sup> To find out whether you are entitled please contact your chosen charging partner.

**Questions?** Please contact your local Retailer to submit an enquiry to your chosen charging partner on your behalf. To find your local Retailer, please click the button at the top right hand corner.

**Warning!** If you are planning to charge your Mercedes-Benz plug-in electric vehicle using a 3-pin domestic plug socket you must get a qualified electrician to inspect and sign off the socket to confirm it is safe and suitable to charge your vehicle. Do not use an electric vehicle 3-pin charge cable with an extension cord.



\*Price excludes £350 OZEV EVHS Grant. Price correct at time of publication, subject to change

<sup>1</sup>The home charger £350 Grant (including VAT) is only available to customers who meet the criteria of the Office for Zero Emission Vehicles (OZEV). For full details and eligibility criteria for the OZEV EVHS Grant, see <https://www.gov.uk/government/publications/electric-vehicle-homecharge-scheme-guidance-for-customers-version-21>.

Design	Technology	Plug-In Hybrid	AMG Line Premium Plus	Model prices	Mercedes-AMG	Mercedes-AMG prices	Mercedes-AMG upholstery	Personalisation	Standard equipment	Genuine accessories	Technical data	Additional information
--------	------------	----------------	-----------------------	--------------	--------------	---------------------	-------------------------	-----------------	--------------------	---------------------	----------------	------------------------



# AMG Line Premium Plus Standard equipment highlights



Option shown: MANUFAKTUR diamond white metallic (code 799)

### Engine, Transmission and Suspension

AIRMATIC air suspension with Adaptive Damping System

**OTR from £76,080<sup>1</sup>**

<sup>1</sup>The recommended on-the-road price includes the Road Fund Licence applicable to the standard model plus delivery charge (£730.00 incl. VAT), new vehicle registration fee (£55.00), fuel (£50.00 incl. VAT), and number plates (£25.00 incl. VAT). VAT is calculated at the standard rate of 20%. Some of the model features, optional extras and colours shown may not be available, or may only be available in a different specification, or at a different price <sup>2</sup>From April 2022 Production onwards



Option shown: MANUFAKTUR diamond white metallic (code 799)

### Exterior

20" AMG alloy wheels – 5-twin-spoke design, painted tremolite grey with a high-sheen finish (code RZV)<sup>2</sup>

Adaptive Highbeam Assist

Aluminium-look illuminated running boards with rubber studs

Heat-insulating dark-tinted glass

KEYLESS-GO Comfort package

MAGIC VISION CONTROL

Mild hybrid with 48-volt on-board electrical system

Mirror package including projection of Mercedes-Benz logo

MULTIBEAM LED

Panoramic glass sunroof

Summer tyres



Design	Technology	Plug-In Hybrid	AMG Line Premium Plus	Model prices	Mercedes-AMG	Mercedes-AMG prices	Mercedes-AMG upholstery	Personalisation	Standard equipment	Genuine accessories	Technical data	Additional information
--------	------------	----------------	-----------------------	--------------	--------------	---------------------	-------------------------	-----------------	--------------------	---------------------	----------------	------------------------



Multifunction sports steering wheel in nappa leather



12.3-inch widescreen cockpit display

**Interior**

Ambient lighting, staged – 64 colours

AMG Line floor mats

Climatised front seats

Dashboard lining in ARTICO man-made leather

Head-up display

Memory package

Multifunction sports steering wheel in nappa leather

Temperature-controlled cup holder

THERMOTRONIC automatic climate control

**Communications, Safety and Assistance Systems**

12.3-inch widescreen cockpit display

Additional USB ports

Blind Spot Assist

Driving Assistance package

MBUX multimedia system with DAB digital radio tuner

Parking package – including Active Parking Assist and reversing camera

Smartphone integration<sup>1</sup>

Two USB ports (type C) in centre console

<sup>1</sup>Compatible mobile phone required

**Trim and Upholstery**

Anthracite open-pore oak wood trim

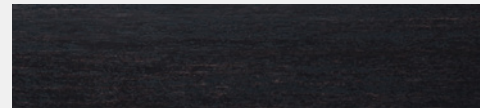

Nappa leather – black

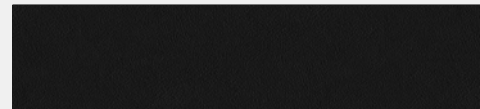



[Book a test drive](#)[Buy your GLE Coupé](#)[Find a Retailer](#)

# Model prices

Model line	Engine	Transmission	CO <sub>2</sub> WLTP <sup>1,*</sup>	Basic RRP excl. VAT (£)	Total RRP incl. VAT (£)	Road Fund Licence (£) <sup>2</sup> WLTP	Rec. OTR price (£) <sup>3</sup> WLTP	P11D value (£)	BiK tax rate 2022/23 (%) <sup>2</sup>
<b>AMG Line Premium Plus</b>									
GLE 350 de 4MATIC	Diesel – 1,950 cc, 4-cylinder, 194 hp/143 kW Electric motor – 136 hp/100kW	9G-TRONIC 9-speed automatic	24	62,683.33	75,220.00	0.00	<b>76,080.00</b>	76,025.00	8
GLE 400 d 4MATIC	Diesel – 2,925 cc, 6-cylinder, 330 hp/243 kW	9G-TRONIC 9-speed automatic	218	62,487.50	74,985.00	1,420.00	<b>77,265.00</b>	75,790.00	37

<sup>1</sup>The indicated values were determined according to the prescribed measurement method - Worldwide Harmonised Light Vehicle Test Procedure (WLTP). Figures shown may include options which are not available in the UK. <sup>2</sup>Figures shown are for comparability purposes; only compare with other cars tested to the same technical procedures. Figures may not reflect real life driving results, which will depend upon a number of factors including factory-fitted options, accessories fitted (post registration), variations in weather, driving styles and vehicle load. Further information about the test used to establish fuel consumption and CO<sub>2</sub> figures can be found at <http://www.mercedes-benz.co.uk/WLTP> <sup>3</sup>GLE 400 d engines are RDE (Real Driving Emissions) Step 2 Certified (Euro 6d). This results in a lower VED and BiK rate as these engines will not be subject to the diesel surcharge. A different first year rate of Vehicle Excise Duty (Road Fund Licence) applies for new cars. Please refer to page 40 for the relevant rate for the second and subsequent years <sup>4</sup>The recommended on-the-road price includes the Road Fund Licence applicable to the standard model plus delivery charge (£730.00 incl. VAT), new vehicle registration fee (£55.00), fuel (£50.00 incl. VAT), and number plates (£25.00 incl. VAT). VAT is calculated at the standard rate of 20%. Some of the model features, optional extras and colours shown may not be available, or may only be available in a different specification, or at a different price



Book a test drive



Buy your GLE Coupé



Find a Retailer



AMG



GLE

# Mercedes-AMG

Design

Technology

Plug-In Hybrid

AMG Line  
Premium Plus

Model prices

Mercedes-AMG

Mercedes-AMG  
prices

Mercedes-AMG  
upholstery

Personalisation

Standard  
equipment

Genuine  
accessories

Technical data

Additional  
information





Book a test drive



Buy your GLE Coupé



Find a Retailer

# Mercedes-AMG GLE Model lines overview



**Mercedes-AMG GLE 53 4MATIC+ Premium Plus »**



**Mercedes-AMG GLE 63 S 4MATIC+ »**

Design	Technology	Plug-In Hybrid	AMG Line Premium Plus	Model prices	Mercedes-AMG	Mercedes-AMG prices	Mercedes-AMG upholstery	Personalisation	Standard equipment	Genuine accessories	Technical data	Additional information
--------	------------	----------------	-----------------------	--------------	--------------	---------------------	-------------------------	-----------------	--------------------	---------------------	----------------	------------------------



# Mercedes-AMG GLE 53 4MATIC+ Premium Plus Standard equipment highlights



Option shown: cavansite blue metallic (code 890)



Option shown: MANUFAKTUR diamond white metallic (code 799)

### Engine, Transmission and Suspension

AMG ACTIVE RIDE CONTROL sports suspension based on AIR BODY CONTROL air suspension

### Exterior

22" AMG alloy wheels – cross-spoke design, painted himalayas grey with a high-sheen finish (code RXU)

AMG bodystyling – front apron with distinctive air intakes, AMG side sill panels and AMG rear apron with diffuser look

'AMG' lettering on front brake callipers

AMG switchable performance exhaust

AMG-specific radiator grille

'BITURBO 4MATIC+' lettering on front wings

Mild hybrid with 48-volt on-board electrical system

Summer tyres



**OTR from £86,285<sup>1</sup>**

<sup>1</sup>The recommended on-the-road price includes the Road Fund Licence applicable to the standard model plus delivery charge (£730.00 incl. VAT), new vehicle registration fee (£55.00), fuel (£50.00 incl. VAT), and number plates (£25.00 incl. VAT). VAT is calculated at the standard rate of 20%. Some of the model features, optional extras and colours shown may not be available, or may only be available in a different specification, or at a different price

Design	Technology	Plug-In Hybrid	AMG Line Premium Plus	Model prices	Mercedes-AMG	Mercedes-AMG prices	Mercedes-AMG upholstery	Personalisation	Standard equipment	Genuine accessories	Technical data	Additional information
--------	------------	----------------	-----------------------	--------------	--------------	---------------------	-------------------------	-----------------	--------------------	---------------------	----------------	------------------------





AMG TRACK PACE

**Interior**

AMG DRIVE UNIT

AMG floor mats with 'AMG' lettering

**Communications, Safety and Assistance Systems**

DAB digital radio tuner

**Trim and Upholstery**

Anthracite open-pore oak wood trim

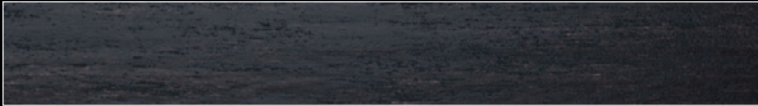

AMG nappa leather – black

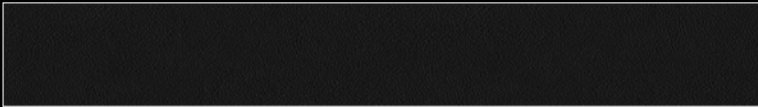



# Mercedes-AMG GLE 63 S 4MATIC+ Standard equipment highlights



Option shown: MANUFAKTUR diamond white metallic (code 799)

In addition to/replacement of Mercedes-AMG GLE 53 4MATIC+ Premium Plus:

**Engine, Transmission and Suspension**

Suspension with adaptive damping system

AMG RIDE CONTROL+

**OTR from £129,205<sup>1</sup>**



Option shown: selenite grey metallic (code 992)

**Exterior**

22" AMG alloy wheels – cross-spoke design, painted matt black with a high-sheen rim flange (code RXV)

AMG Driver's package

AMG Night package

AMG high-performance composite braking system

AMG performance exhaust system

Front door sill panels with 'AMG' lettering

Red brake callipers with 'AMG' lettering

Summer tyres



<sup>1</sup>The recommended on-the-road price includes the Road Fund Licence applicable to the standard model plus delivery charge (£730.00 incl. VAT), new vehicle registration fee (£55.00), fuel (£50.00 incl. VAT), and number plates (£25.00 incl. VAT). VAT is calculated at the standard rate of 20%. Some of the model features, optional extras and colours shown may not be available, or may only be available in a different specification, or at a different price

Design	Technology	Plug-In Hybrid	AMG Line Premium Plus	Model prices	Mercedes-AMG	Mercedes-AMG prices	Mercedes-AMG upholstery	Personalisation	Standard equipment	Genuine accessories	Technical data	Additional information
--------	------------	----------------	-----------------------	--------------	--------------	---------------------	-------------------------	-----------------	--------------------	---------------------	----------------	------------------------





Additional USB ports

### Interior

- Comfort front head restraints
- Dashboard – upper part in nappa leather
- DINAMICA microfibre roof liner in black
- Heated rear seats
- Multi-contour front seats
- Multifunction sports steering wheel in nappa leather/DINAMICA microfibre

### Communications, Safety and Assistance Systems

- DAB digital radio tuner
- Driving Assistance Plus package

### Trim and Upholstery

- AMG carbon-fibre trim
- AMG Exclusive nappa leather - magma grey/black



Design	Technology	Plug-In Hybrid	AMG Line Premium Plus	Model prices	Mercedes-AMG	Mercedes-AMG prices	Mercedes-AMG upholstery	Personalisation	Standard equipment	Genuine accessories	Technical data	Additional information
--------	------------	----------------	-----------------------	--------------	--------------	---------------------	-------------------------	-----------------	--------------------	---------------------	----------------	------------------------





Book a test drive



Buy your GLE Coupé



Find a Retailer

# Become the AMG expert

Unleash a new level of performance.



Step into the world of performance and experience the AMG brand at Mercedes-Benz World – from the powerful sound of the engines to the smell of the leather to the unmistakable design of our vehicles.

Mercedes-Benz World invites all Mercedes-AMG customers to a complimentary adrenaline-packed driving experience. Feel the sensational AMG driving performance, develop your driving skills and even try your hand at power-sliding on the Wet Skid Circle. With expert one-to-one guidance from a Driving Specialist in the passenger seat, experience every inch of our Handling Circuits, Dynamic Straight and low friction surfaces.

[Click here for more information](#)



#### TERMS AND CONDITIONS

The following customers only are eligible: The first purchaser/ registered keeper of a newly registered Mercedes-AMG. The complimentary Training must be booked and taken within 12 months of delivery of your Mercedes-AMG, the Training is offered on specific days only and subject to availability. Upgrades are available for an additional cost, details upon request. Transferable to individuals who reside at the same postal address only. Mercedes-Benz Cars UK Limited reserves the right to amend or withdraw this Training experience. Attendees must hold a full UK driving licence. Attendees will be required to sign the Mercedes-Benz World Driving Risk Acknowledgement prior to undertaking the Training experience. The Training experience is also subject to the Mercedes-Benz World Terms and Conditions, as applicable. Invitation is emailed to the customer post-delivery, permission via the customer contact preferences must be given to enable Mercedes-Benz World to contact. Retailer demonstrator vehicles are not eligible.

Design	Technology	Plug-In Hybrid	AMG Line Premium Plus	Model prices	Mercedes-AMG	Mercedes-AMG prices	Mercedes-AMG upholstery	Personalisation	Standard equipment	Genuine accessories	Technical data	Additional information
--------	------------	----------------	-----------------------	--------------	--------------	---------------------	-------------------------	-----------------	--------------------	---------------------	----------------	------------------------



[Book a test drive](#)[Buy your GLE Coupé](#)[Find a Retailer](#)

# Mercedes-AMG prices

Model line	Engine	Transmission	Seats	CO <sub>2</sub> WLTP <sup>1</sup> *	Basic RRP excl. VAT (£)	Total RRP incl. VAT (£)	Road Fund Licence (£) <sup>2</sup> WLTP	Rec. OTR price (£) <sup>3</sup> WLTP	P11D value (£)	BiK tax rate 2022/23 (%) <sup>2</sup>
Mercedes-AMG GLE53 4MATIC+ Premium Plus	Petrol – 2,999 cc, 6-cylinder, 435 hp/320 kW Mild hybrid drive – 22 hp/16 kW	AMG SPEEDSHIFT TCT 9G automatic	245	246	69,516.66	83,420.00	2,005.00	<b>86,285.00</b>	84,225.00	37
Mercedes-AMG GLE63 S 4MATIC+	Petrol – 3,982 cc, 8-cylinder, 612 hp/450 kW Mild hybrid drive – 22 hp/16 kW	AMG SPEEDSHIFT TCT 9G automatic	280	247	104,991.66	125,990.00	2,355.00	<b>129,205.00</b>	126,795.00	37

<sup>1</sup>The indicated values were determined according to the prescribed measurement method - Worldwide Harmonised Light Vehicle Test Procedure (WLTP). Figures shown may include options which are not available in the UK. <sup>2</sup>Figures shown are for comparability purposes; only compare with other cars tested to the same technical procedures. Figures may not reflect real life driving results, which will depend upon a number of factors including factory-fitted options, accessories fitted (post registration), variations in weather, driving styles and vehicle load. Further information about the test used to establish fuel consumption and CO<sub>2</sub> figures can be found at <http://www.mercedes-benz.co.uk/WLTP> <sup>3</sup>A different first year rate of Vehicle Excise Duty (Road Fund Licence) applies for new cars. Please refer to page 51 for the relevant rate for the second and subsequent years <sup>4</sup>The recommended on-the-road price includes the Road Fund Licence applicable to the standard model plus delivery charge (£730.00 incl. VAT), new vehicle registration fee (£55.00), fuel (£50.00 incl. VAT), and number plates (£25.00 incl. VAT). VAT is calculated at the standard rate of 20%. Some of the model features, optional extras and colours shown may not be available, or may only be available in a different specification, or at a different price

Design	Technology	Plug-In Hybrid	AMG Line Premium Plus	Model prices	Mercedes-AMG	Mercedes-AMG prices	Mercedes-AMG upholstery	Personalisation	Standard equipment	Genuine accessories	Technical data	Additional information
--------	------------	----------------	-----------------------	--------------	--------------	---------------------	-------------------------	-----------------	--------------------	---------------------	----------------	------------------------



Book a test drive



Buy your GLE Coupé



Find a Retailer



# Mercedes-AMG upholstery

Standard  No-cost option



**851A AMG nappa leather<sup>1</sup> – black**

Mercedes-AMG GLE 53 4MATIC+ Premium Plus



**854A AMG nappa leather<sup>1</sup> – truffle brown/black**

Mercedes-AMG GLE 53 4MATIC+ Premium Plus



**857A AMG nappa leather<sup>1</sup> – red pepper/black**

Mercedes-AMG GLE 53 4MATIC+ Premium Plus



<sup>1</sup>100% of seat upholstery is pure leather

Design	Technology	Plug-In Hybrid	AMG Line Premium Plus	Model prices	Mercedes-AMG	Mercedes-AMG prices	Mercedes-AMG upholstery	Personalisation	Standard equipment	Genuine accessories	Technical data	Additional information
--------	------------	----------------	-----------------------	--------------	--------------	---------------------	-------------------------	-----------------	--------------------	---------------------	----------------	------------------------





Book a test drive



Buy your GLE Coupé



Find a Retailer



# Mercedes-AMG upholstery

- Standard
- No-cost option



**571A AMG Exclusive nappa leather<sup>1</sup> - magma grey/black**

Mercedes-AMG GLE 63 S 4MATIC+



**551A AMG Exclusive nappa leather<sup>1</sup> - black**

Mercedes-AMG GLE 63 S 4MATIC+



<sup>1</sup>100% of seat upholstery is pure leather

Design	Technology	Plug-In Hybrid	AMG Line Premium Plus	Model prices	Mercedes-AMG	Mercedes-AMG prices	Mercedes-AMG upholstery	Personalisation	Standard equipment	Genuine accessories	Technical data	Additional information
--------	------------	----------------	-----------------------	--------------	--------------	---------------------	-------------------------	-----------------	--------------------	---------------------	----------------	------------------------



Book a test drive



Buy your GLE Coupé



Find a Retailer

# Colour options

● Standard

Total prices incl. VAT



149 polar white non-metallic



859 mojave silver metallic

£795.00



922 high-tech silver metallic

£795.00



799 MANUFAKTUR diamond white metallic

£955.00



197 obsidian black metallic

£795.00



890 cavansite blue metallic

£795.00



992 selenite grey metallic

£795.00



996 MANUFAKTUR hyacinth red metallic

£955.00

Please note that, owing to limitations of on-screen representation, paint colours may differ from those shown

Design	Technology	Plug-In Hybrid	AMG Line Premium Plus	Model prices	Mercedes-AMG	Mercedes-AMG prices	Mercedes-AMG upholstery	Personalisation	Standard equipment	Genuine accessories	Technical data	Additional information
--------	------------	----------------	-----------------------	--------------	--------------	---------------------	-------------------------	-----------------	--------------------	---------------------	----------------	------------------------





Book a test drive



Buy your GLE Coupé



Find a Retailer

# Towing package

The Towing package offers an electronically folding tow bar which increases the towing capacity up to 3,500 kg.

**Towing package** (code DP8) – designed as a package, including items as listed.

**Available on all models**

**Total incl. VAT £1,500**

### Towing package comprises:

Electronically folding tow bar (includes 13-pin socket; ESC: Electronic Stability Control)

Increased towing capacity – max. 3,500 kg



Some of the model features, optional extras and colours shown may not be available, or may only be available in a different specification, or at a different price

Design	Technology	Plug-In Hybrid	AMG Line Premium Plus	Model prices	Mercedes-AMG	Mercedes-AMG prices	Mercedes-AMG upholstery	Personalisation	Standard equipment	Genuine accessories	Technical data	Additional information
--------	------------	----------------	-----------------------	--------------	--------------	---------------------	-------------------------	-----------------	--------------------	---------------------	----------------	------------------------

[Book a test drive](#)[Buy your GLE Coupé](#)[Find a Retailer](#)

# Standard equipment

● Standard    – Not available

## Engine, Transmission and Suspension

	GLE53 4MATIC+ AMG Line Premium Plus	GLE63 S 4MATIC+ Premium Plus	
9G-TRONIC automatic transmission with steering column gear selector, DIRECT SELECT steering wheel gearshift paddles, cruise control and speed limiter	●	–	–
AIRMATIC air suspension with Adaptive Damping System	●	–	–
AMG ACTIVE RIDE CONTROL sports suspension based on AIR BODY CONTROL air suspension	–	●	●
AMG DYNAMIC SELECT with a choice of driving modes: 'Comfort', 'Sport', 'Sport+', 'Slippery' and 'Individual'	–	●	●
AMG SPEEDSHIFT TCT 9G automatic transmission with steering column gear selector, DIRECT SELECT steering wheel gearshift paddles, cruise control and speed limiter	●	●	●
DYNAMIC SELECT with a choice of driving modes: 'Comfort', 'Sport', 'ECO' and 'Individual'	●	–	–
ECO start/stop function	–	●	●
Mild hybrid with 48-volt on-board electrical system	●	●	●
Permanent four-wheel drive	●	●	●

## Steering

Sports Direct-Steer system with speed-sensitive power assistance	●	●	●
Steering column - electrically adjustable with memory for height and reach	●	●	●
Steering wheel - 3-spoke AMG sports steering wheel in black nappa leather with flattened bottom rim	●	–	–
Steering wheel - 4-spoke AMG performance steering wheel in nappa leather	–	●	●
Steering wheel - multifunction, with gearshift paddles	●	●	●
Steering wheel - touch-control buttons for audio and onboard settings	●	●	●

## Exterior

85-litre fuel tank	●	●	●
Adaptive Highbeam Assist Plus	●	●	●

	GLE53 4MATIC+ AMG Line Premium Plus	GLE63 S 4MATIC+ Premium Plus	
Aluminium-look, illuminated running boards with rubber studs	●	●	●
AMG bodystyling - front and rear bumpers	●	–	–
AMG bodystyling - front apron with distinctive air intakes, AMG side sill panels and AMG rear apron with diffuser look	–	●	●
AMG Night package	–	–	●
AMG rear spoiler in vehicle colour	–	●	–
AMG specific radiator grille with vertical bars in high-gloss chrome and AMG logo	–	●	●
'BITURBO 4MATIC+' lettering on front wings	–	●	●
EASY-PACK powered tailgate - the EASY-PACK boot lid can be opened and closed at the touch of a button for more convenient loading and unloading of the boot	●	●	●
Exhaust system - twin-pipe, with two integrated chrome tailpipe trims	●	–	–
Exhaust system - two chrome-plated twin-tailpipe switchable performance exhausts	–	●	●
Exterior mirrors - black	–	–	●
Exterior mirrors - body colour	●	●	–
Headlamps - MULTIBEAM LED	●	●	●
LED tail lamps	●	●	●
MAGIC VISION CONTROL - adaptive windscreen wiper system allowing the driver the best possible visibility even during the wiping process. Washerfluid is sprayed directly in front of the wiper blades and wiped away without delay. A heating system effectively lowers the risk of icing up	●	●	●
Mirror package - including heated exterior mirrors, automatically dimming rear view mirror and exterior mirror on driver's side, electrically folding exterior mirrors left and right, and projection of Mercedes-Benz logo integrated into both mirrors	●	●	●
Panoramic electric sunroof with interior sun blind	●	●	●

Design

Technology

Plug-In Hybrid

AMG Line  
Premium Plus

Model prices

Mercedes-AMG

Mercedes-AMG  
pricesMercedes-AMG  
upholstery

Personalisation

Standard  
equipmentGenuine  
accessories

Technical data

Additional  
information





# Standard equipment

● Standard – Not available

## Exterior (continued)

	GLE53 4MATIC+ AMG Line Premium Plus	GLE63 S 4MATIC+ Premium Plus	GLE63 S 4MATIC+ Premium Plus
Parking Pilot with 360° camera – the Parking Pilot makes finding a parking space as well as parking in and leaving on-end parking spaces easier. The 360° camera enables parking and manoeuvring with a realistic all-round view thanks to the interaction of four networked cameras	●	●	●
Perforated front brake discs and brake callipers with 'Mercedes-Benz' lettering	●	–	–
Perforated front brake discs and red brake callipers with 'AMG' lettering	–	–	●
Perforated front brake discs and silver brake callipers with 'AMG' lettering	–	●	–
Privacy glass – dark glass from B-pillar backwards	●	●	●
Radiator grille with integrated star – single louvre in matt iridium silver with chrome trim	●	–	–
Rain-sensing wipers	●	●	●
Rear screen wash/wiper	●	●	●
Soft close doors	–	–	●
TIREFIT with tyre inflation compressor	●	●	●
Top surround of side windows in polished aluminium	●	●	–
Underbody protection with chrome-look finish front and rear	●	●	–
URBAN GUARD Vehicle Protection package	●	●	●

## Wheels

20" AMG alloy wheels – 5-twin-spoke design, painted tremolite grey with a high-sheen finish, 275/50 (front and rear) tyres (code RZV) <sup>1</sup>	●	–	–
22" AMG alloy wheels – cross-spoke design, painted himalayas grey with a high-sheen finish, 285/40 (front) and 325/35 (rear) R22 tyres (code RXU)	–	●	–
22" AMG alloy wheels – cross-spoke design, painted matt black with a high-sheen rim flange, 285/40 (front) and 325/35 (rear) R22 tyres (code RXV)	–	–	●
Summer tyres with noise-reducing foam absorber	●	●	●

<sup>1</sup>From April 2022 Production onwards

## Interior

	GLE53 4MATIC+ AMG Line Premium Plus	GLE63 S 4MATIC+ Premium Plus	GLE63 S 4MATIC+ Premium Plus
Acoustic Comfort package – laminated safety glass with infrared-reflecting film for the windscreen, laminated safety glass with an infrared-absorbing film for the side windows and other noise-insulating measures	●	●	●
AMG DRIVE UNIT	–	●	●
AMG sports seats with AMG-specific seat upholstery layout, optimised lateral support and AMG badge in front seat backrests	–	●	●
AMG Line floor mats	●	–	–
AMG floor mats with 'AMG' lettering	–	●	●
Ambient lighting – 64 colours, staged	●	●	●
Centre armrests – front, with stowage compartment and illuminated grab handles	●	●	●
Centre armrests – rear, folding	●	●	●
Charging cable for domestic plug socket, 8 metres, straight (GLE350 de only)	●	–	–
Charging cable for wallbox and public charging stations, 8 metres, straight (GLE 350 de only)	●	–	–
Cup holders – front (2) and rear (2)	●	●	●
Cup holders – temperature-controlled for driver and front passenger	●	●	●
Courtesy lights in rear grab handles with reading light functionality	●	●	●
Dashboard – upper part in ARTICO man-made leather	●	●	–
Dashboard – upper part in nappa leather	–	–	●
DINAMICA roof liner	–	–	●
Electric windows (4) – with one-touch opening and closing, including obstruction sensors	●	●	●
Electronic key – chrome surround	●	●	●
Front seats – heated and climatized	●	●	●
Glasses compartment in overhead control panel	●	●	●

[Book a test drive](#)[Buy your GLE Coupé](#)[Find a Retailer](#)

# Standard equipment

● Standard    – Not available

## Interior (continued)

	GLE53 4MATIC+ AMG Line Premium Plus	GLE63 S 4MATIC+ Premium Plus	GLE63 S 4MATIC+ Premium Plus
Glove compartment – lockable, air-conditioned and illuminated	●	●	●
Head restraints – electrically adjustable, front	●	●	●
Head-up display	●	●	●
Illuminated stainless steel door sill panels with 'Mercedes-Benz' lettering	●	–	–
Illuminated stainless steel door sill panels with 'AMG' lettering	–	●	●
Instrument cluster – AMG main menu, including RACETIMER and AMG start-up display. Displays valuable information for sporty drivers presented in an inspiring AMG design. With RACETIMER it is possible to measure lap times	–	●	●
Instrument cluster – widescreen (12.3-inch) cockpit display High resolution screen with choice of three display styles and unique ambient lighting settings based on display styles 'Classic', 'Progressive' or 'Sport'	●	●	●
Interior chrome package	●	●	●
KEYLESS-GO Comfort package – vehicle can be conveniently unlocked, started and locked with this system – simply by carrying the electronic key	●	●	●
KEYLESS-GO starting function	●	●	●
Luggage compartment cover	●	●	●
Memory package – driver's seat, front passenger seat, steering column and exterior mirrors – electrically adjustable with memory	●	●	●
Rear seats – split folding 40:20:40	●	●	●
Sports pedals in brushed stainless steel with rubber studs	●	●	●
Sun visors with illuminated vanity mirrors	●	●	●
THERMOTRONIC automatic climate control – four-zone function with separate air distribution settings for driver/front passenger and rear	●	●	●
Warmth Comfort package – seat heating Plus for driver and front passenger: comprises seat cushions and seat backrests Armrest heating for driver and front passenger: comprises armrests in the doors, centre console and door centre panels	–	–	●

## Paint, Trim and Upholstery

	GLE53 4MATIC+ AMG Line Premium Plus	GLE63 S 4MATIC+ Premium Plus	GLE63 S 4MATIC+ Premium Plus
Paint – non-metallic	●	●	●
Trim – AMG carbon fibre	–	–	●
Trim – anthracite open-pore oak wood	●	●	–
Upholstery – AMG Exclusive Nappa leather	–	–	●
Upholstery – AMG nappa leather	–	●	–
Upholstery – nappa leather	●	–	–

## Security and Assistance Systems

	GLE53 4MATIC+ AMG Line Premium Plus	GLE63 S 4MATIC+ Premium Plus	GLE63 S 4MATIC+ Premium Plus
Active Brake Assist	●	●	●
Active bonnet – pedestrian safety measure	●	●	●
Adaptive brake lights	●	●	●
Airbags – driver and front passenger	●	●	●
Airbags – driver's kneebag	●	●	●
Airbags – front sidebags	●	●	●
Airbags – rear sidebags	–	–	●
Airbags – windowbags	●	●	●
Alarm system with immobiliser and interior protection (MBSS3)	●	●	●
Anti-lock braking system (ABS) with Brake Assist (BAS)	●	●	●
ATTENTION ASSIST – continuously analyses driver behaviour and steering movements. If patterns are recognised which characterise drowsiness, the driver is prompted to take a break, and an audible warning is sounded	●	●	●
Automatic child seat recognition sensor – when the front passenger seat is unoccupied or a child seat is detected, the front passenger airbag is automatically deactivated	●	●	●



[Book a test drive](#)[Buy your GLE Coupé](#)[Find a Retailer](#)

# Standard equipment

● Standard    – Not available

## Security and Assistance Systems (continued)

	GLE53 4MATIC+ AMG Line Premium Plus	GLE63 S 4MATIC+ Premium Plus	GLE63 S 4MATIC+ Premium Plus
Blind Spot Assist	●	●	●
Braking – Adaptive Brake Assist with HOLD function and Hill Start Assist	●	●	●
Crosswind Assist – detects sudden, strong gusts of wind and helps the driver stay in lane by means of targeted braking	●	●	●
Downhill Speed Regulation (DSR) with on/off switch and variable speed control	●	●	●
Driving Assistance package (please visit page 10 for more information)	●	●	–
Driving Assistance Plus package (please visit page 10 for more information)	–	–	●
Electric parking brake	●	●	●
Electronic Stability Programme (ESP®) with Acceleration Skid Control (ASR)	●	●	●
First-aid kit, warning triangle and high visibility jacket	●	●	●
Four-wheel Electronic Traction System (4ETS)	●	●	●
ISOFIX child seat attachment points in the rear (two outer seats)	●	●	●
Lane Keeping Assist	●	●	●
Outside temperature display, rear seat belt status indicator	●	●	●
PRE-SAFE® anticipatory safety system with reversible belt tensioners for driver and front passenger seats, closing function for side windows	●	●	●
Remote central locking	●	●	●
Service indicator ASSYST	●	●	●
Traffic Sign Assist – Speed Limit Assist with wrong-way warning function and display of speed limit in instrument cluster	●	●	●
Tyre pressure monitoring system	●	●	●

## Communications and In-Car Entertainment

	GLE53 4MATIC+ AMG Line Premium Plus	GLE63 S 4MATIC+ Premium Plus	GLE63 S 4MATIC+ Premium Plus
Bluetooth® interface for hands-free telephony and audio streaming for music transmission	●	●	●
DAB digital radio tuner	●	●	●
MBUX multimedia system	●	●	●
Mercedes me connect services – for example accident recovery, breakdown management and maintenance management, or telediagnosics for worn parts	●	●	●
Remote Online technical preparation for the use of Mercedes me connect services – for example remote query, vehicle status, vehicle location, etc., possible via smartphone	●	●	●
Smartphone integration <sup>1</sup> – comprising Apple CarPlay® and Android Auto™. Please check on <a href="http://www.apple.com/uk/ios/carplay/">www.apple.com/uk/ios/carplay/</a> or <a href="http://www.android.com/intl/en_uk/auto">www.android.com/intl/en_uk/auto</a> for compatibility and approved apps. Certain features and apps require a 3G or 4G data connection. Control of features available through voice control and controller on centre console	●	●	●
Touchpad	●	●	●
Two USB ports (type C) in centre console	●	●	●
Widescreen (12.3-inch) cockpit display	●	●	●

<sup>1</sup>Compatible mobile phone required. Please check [www.mercedes-benz-mobile.com](http://www.mercedes-benz-mobile.com) for details or contact your local Mercedes-Benz Retailer for further information

# Genuine accessories

We've developed a range of accessories you can add to help personalise and enhance your GLE.



### Concertina load sill protector

Foldable protective mat. Easy to attach. Protects bumper and load sill from scratches. Helps keep the load area clean. Helps protect clothing when loading boot/load compartment or roof box. Can be connected to boot tub and reversible mat. Space-saving stowage. Easy to clean. (A2536932000)



### Shallow boot tub

The boot tub is suitable for transporting shopping. The tub shape with its slightly raised edge is precision-tailored to the load area. Made from impact-resistant, non-slip polypropylene. Cannot be used in conjunction with third row of seats or hybrid vehicles. (A2928140000)

### LED Mercedes star projector

The legendary three-pointed star logo is discreetly projected onto the ground alongside your vehicle every time you open the front driver or passenger door. The star automatically disappears once the doors are closed. Not in conjunction with Mirror package. (A2138204503)



### Floor mat trays

Made from robust, washable synthetic material for heavy use. Covers the entire footwell. The raised edges and structured surface help keep the floor clean and dry. With distinctive 'Mercedes-Benz' lettering. (A16668036019051)



All the above accessories are subject to availability and compatibility. Please ask your Mercedes-Benz Retailer for more information

Design	Technology	Plug-In Hybrid	AMG Line Premium Plus	Model prices	Mercedes-AMG	Mercedes-AMG prices	Mercedes-AMG upholstery	Personalisation	Standard equipment	Genuine accessories	Technical data	Additional information
--------	------------	----------------	-----------------------	--------------	--------------	---------------------	-------------------------	-----------------	--------------------	---------------------	----------------	------------------------



**Alustyle Easy-Fix II basic carrier bars for roof rails**

Aluminium carrier bars, precision-tailored to the body of your Mercedes-Benz – the perfect basis for a range of Mercedes-Benz transport solutions: ski and snowboard rack, bicycle rack or roof boxes. (A1668901593)



**Mercedes-Benz roof boxes**

An aerodynamic design, tailored to your Mercedes-Benz. In extremely durable material. Designed for quick, optimised attachment to the basic carrier bars. Particularly convenient loading and unloading thanks to the option of double-sided opening. Lockable from both sides. Available in various sizes. (part numbers vary)

**Alustyle bicycle rack**

Extremely lightweight bicycle rack, designed to allow you to attach a bicycle to the basic carrier bars for roof rails. Bicycles can either be attached to the rack once it has been fitted to the roof or, conveniently, before it is fitted. The support frame can also be folded down when not in use to reduce drag when travelling without cycles. (A0008900293)



**Ski and snowboard rack, Comfort**

The Comfort ski and snowboard rack is designed to hold a maximum of six pairs of skis (without sticks) or up to two snowboards, depending on the height of the bindings. (A0008900393)



**Door handle recess, small, two-piece**

An exclusive highlight: the refined, chrome-design door handle recesses lend the vehicle a polished, individual look. The stable, robust material is precision-tailored to the bodywork and protects the paintwork in the recess from scratches. Set of two. (A2057604200)

All the above accessories are subject to availability and compatibility. Please ask your Mercedes-Benz Retailer for more information

[Book a test drive](#)[Buy your GLE Coupé](#)[Find a Retailer](#)

# Technical data

Model	GLE 350 de 4MATIC	GLE 400 d 4MATIC	Mercedes-AMG GLE53 4MATIC+	Mercedes-AMG GLE63 S 4MATIC+
<b>Engine</b>				
Fuel delivery	Diesel	Diesel	Petrol	Petrol
Total displacement	cc 1,950	2,925	2,999	3,982
Arrangement/cylinders/valves	inline/4/16	in-line/6/24	in-line/6/24	inline/8/32
Power <sup>1</sup>	hp (kW) at rpm			
Combustion engine	194 (143)/3,800–4,000	330 (243)/3,600–4,200	435 (320)/5,500–6,100	612 (450)/5,750–6,500
Electric motor [Mild hybrid drive]	136 [100]	-	22 [16]	22 [16]
System output	320 (235)	-	-	-
Torque <sup>1</sup>	Nm at rpm			
Combustion engine	400/1,600–2,800	700/1,200–3,200	520/1,800–5,800	850/2,500–4,500
Electric motor [Mild hybrid drive]	[440]	-	-	-
System output	700	-	-	-
Compression ratio	15.5:1	15.5:1	10.5:1	8.6:1
Equivalent All-Electric Range (EAER) <sup>2</sup>	mi 54	-	-	-
Battery type (usable)	kWh Lithium-ion/31.0	-	-	-
Power consumption, combined <sup>2</sup>	kWh/100 km 29.7–29.4	-	-	-
AC charging time, 10–100% <sup>3</sup>				
At a domestic socket <sup>4</sup>	11 hrs 30 mins	-	-	-
At a wallbox (3.7 kW AC Single Phase)	6 hrs 45 mins	-	-	-
At a charging station (7.4 kW AC Three Phase)	3 hrs 30 mins	-	-	-
DC charging time, 10–80% (60 kW)	20 mins	-	-	-
Capacity on-board charger	3.7 kW (AC Single Phase)/ 7.4 kW (AC Three Phase)/ 60 kW (DC)	-	-	-
Emissions standard	EURO 6D-ISC-FCM	EURO 6D-ISC-FCM	EURO 6D-ISC-FCM	EURO 6D-ISC-FCM

<sup>1</sup>Figures according to Directive 80/1269/EEC in the currently applicable version    <sup>2</sup>The indicated values were determined according to the prescribed measurement method - Worldwide Harmonised Light Vehicle Test Procedure (WLTP). Figures shown may include options which are not available in the UK. For Plug-in Hybrid Electric Vehicle (PHEV) figures determined with the battery fully charged, using a combination of both battery power and fuel. These models require mains electricity for charging    <sup>3</sup>Specified voltage and current values refer to network infrastructure and can be limited by the vehicle    <sup>4</sup>If you are planning to charge your Mercedes-Benz plug-in electric vehicle using a 3-pin domestic plug socket you must get a qualified electrician to inspect and sign off the socket to confirm it is safe and suitable to charge your vehicle. Do not use an electric vehicle 3-pin charge cable with an extension cord



[Book a test drive](#)[Buy your GLE Coupé](#)[Find a Retailer](#)

# Technical data

● Standard    – Not available

Model	GLE 350 de 4MATIC		GLE 400 d 4MATIC		Mercedes-AMG GLE 53 4MATIC+		Mercedes-AMG GLE 63 S 4MATIC+		
<b>Transmission</b>									
9G-TRONIC PLUS 9-speed automatic		●		●		–		–	
AMG SPEEDSHIFT TCT 9G automatic		–		–		●		●	
<b>Performance</b>									
Acceleration 0–62 mph	sec	6.9		5.7		5.3		3.8	
Top speed (electric mode)	mph	130 (53–62)		149		155 <sup>5</sup>		174 <sup>5</sup>	
<b>Weights and capacities</b>									
Kerb weight <sup>6</sup>	kg	2,690		2,310		2,325		2,445	
Perm. Gross Vehicle Weight	kg	3,230		3,040		3,050		3,120	
Boot capacity – seats up/seats down	l	510/1,645		655/1,790		655/1,790		655/1,790	
Towing capacity – unbraked/braked	kg	750/2,700		750/2,700		750/3,500		750/3,500	
Fuel tank capacity/of which reserve	l	65/9.0		85/9.0		85/9.0		85/12.0	
Turning circle	m	11.84		11.84		12.3		12.3	
<b>Fuel consumption<sup>7,8,9</sup></b>									
Combined (consumption dependent on chosen optional equipment)	l/100 km mpg	0.9 313.9		8.4–8.3 33.6–34.0		10.8 26.2		12.4–12.3 22.8–23.0	
<b>Insurance</b>									
Group rating		tba		tba		tba		tba	

Insurance ratings may vary depending on model line and specification. Please refer to <http://www.thatcham.org/abigrouprating/> for further details

<sup>5</sup>Electronically limited    <sup>6</sup>Figures according to Directive 92/21/EC (kerb weight with fuel tank 90% full, driver, 68 kg, and luggage, 7 kg) for standard-specification vehicles. Optional extras and accessories will generally increase this figure and reduce the payload capacity accordingly    <sup>7</sup>All figures are based on a standard specification with the smallest tyre size    <sup>8</sup>The choice of wheels and transmission may affect CO<sub>2</sub> emissions and corresponding Road Fund Licence    <sup>9</sup>The indicated values were determined according to the prescribed measurement method – Worldwide Harmonised Light Vehicle Test Procedure (WLTP). Figures shown may include options which are not available in the UK. Figures shown are for comparability purposes; only compare with other cars tested to the same technical procedures. Figures may not reflect real life driving results, which will depend upon a number of factors including factory-fitted options, accessories fitted (post registration), variations in weather, driving styles and vehicle load. Further information about the test used to establish fuel consumption and CO<sub>2</sub> figures can be found at <http://www.mercedes-benz.co.uk/WLTP>



Book a test drive



Buy your GLE Coupé



Find a Retailer

## AMG Line Premium Plus

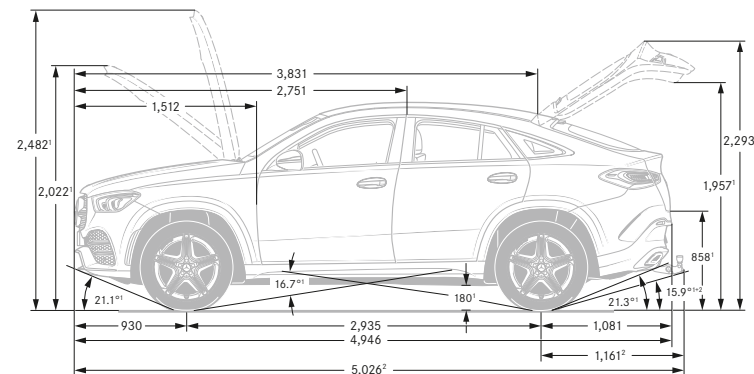
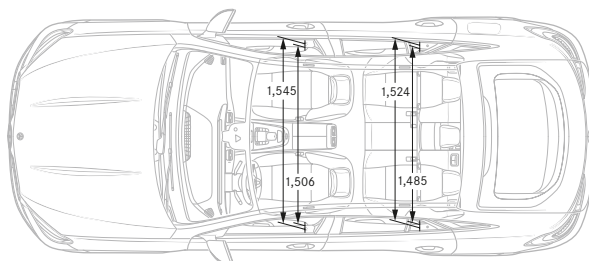
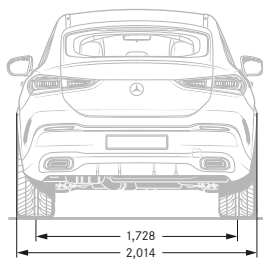
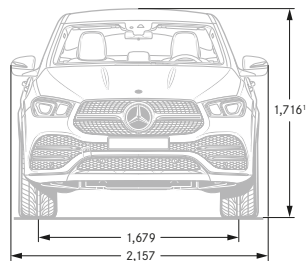

## Mercedes-AMG GLE 53 4MATIC+ Premium Plus

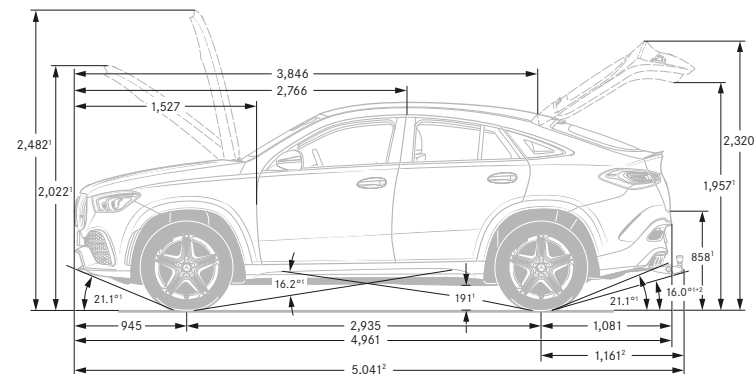
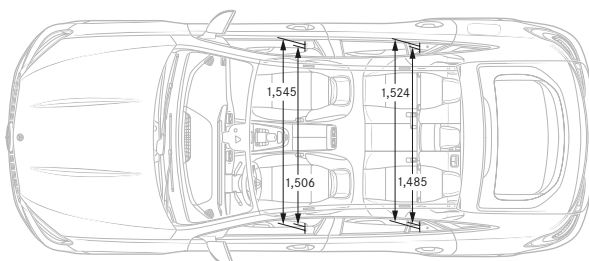
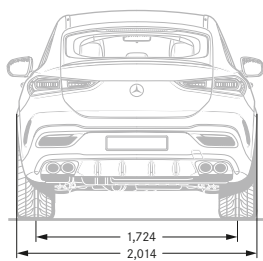
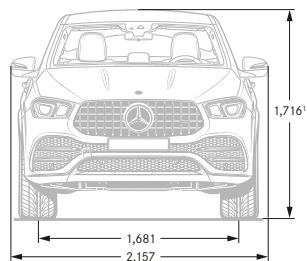

All measurements in millimetres. The dimensions shown are mean values and apply to standard-specification, unladen vehicles

Design	Technology	Plug-In Hybrid	AMG Line Premium Plus	Model prices	Mercedes-AMG	Mercedes-AMG prices	Mercedes-AMG upholstery	Personalisation	Standard equipment	Genuine accessories	Technical data	Additional information
--------	------------	----------------	-----------------------	--------------	--------------	---------------------	-------------------------	-----------------	--------------------	---------------------	----------------	------------------------

[Book a test drive](#)[Buy your GLE Coupé](#)[Find a Retailer](#)

# Mercedes-AMG GLE 63 S 4MATIC+

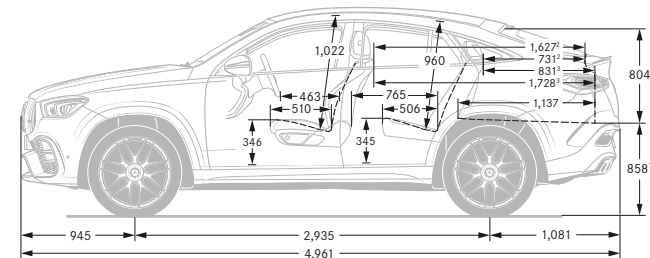
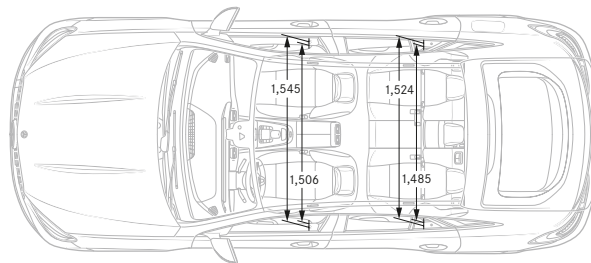
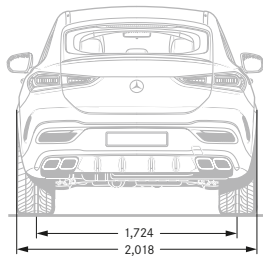
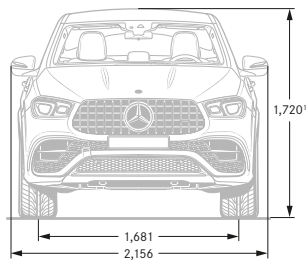

All measurements in millimetres. The dimensions shown are mean values and apply to standard-specification, unladen vehicles

Design	Technology	Plug-In Hybrid	AMG Line Premium Plus	Model prices	Mercedes-AMG	Mercedes-AMG prices	Mercedes-AMG upholstery	Personalisation	Standard equipment	Genuine accessories	Technical data	Additional information
--------	------------	----------------	-----------------------	--------------	--------------	---------------------	-------------------------	-----------------	--------------------	---------------------	----------------	------------------------



[Book a test drive](#)[Buy your GLE Coupé](#)[Find a Retailer](#)

# Road Fund Licence

All road vehicle registrations are subject to Vehicle Excise Duty (Road Fund Licence), which varies in accordance with the vehicle's CO<sub>2</sub> emissions. A first year rate for each taxation band will apply. The table below shows the bands (A-M) created by the DVLA and the corresponding Road Fund Licence. CO<sub>2</sub> emissions and the relevant Excise Duty are shown on the model pricing pages.

Band	CO <sub>2</sub> emissions (g/km)	First year rate petrol and RDE2 diesel (£)	First year rate all other diesel (£) <sup>1</sup>	First year rate alternative fuel (£)	Electric vehicles		Alternative fuel vehicles		Petrol/diesel vehicles	
					Standard rate (£)	Premium rate (£) <sup>2</sup>	Standard rate (£)	Premium rate (£) <sup>2</sup>	Standard rate (£)	Premium rate (£) <sup>2</sup>
A	0	0.00	0.00	0.00	0.00	0.00	0.00	0.00	0.00	0.00
B	1 to 50	10.00	25.00	0.00	0.00	0.00	155.00	510.00	165.00	520.00
C	51 to 75	25.00	120.00	15.00	0.00	0.00	155.00	510.00	165.00	520.00
D	76 to 90	120.00	150.00	110.00	0.00	0.00	155.00	510.00	165.00	520.00
E	91 to 100	150.00	170.00	140.00	0.00	0.00	155.00	510.00	165.00	520.00
F	101 to 110	170.00	190.00	160.00	0.00	0.00	155.00	510.00	165.00	520.00
G	111 to 130	190.00	230.00	180.00	0.00	0.00	155.00	510.00	165.00	520.00
H	131 to 150	230.00	585.00	220.00	0.00	0.00	155.00	510.00	165.00	520.00
I	151 to 170	585.00	945.00	575.00	0.00	0.00	155.00	510.00	165.00	520.00
J	171 to 190	945.00	1,420.00	935.00	0.00	0.00	155.00	510.00	165.00	520.00
K	191 to 225	1,420.00	2,015.00	1,410.00	0.00	0.00	155.00	510.00	165.00	520.00
L	226 to 255	2,015.00	2,365.00	2,005.00	0.00	0.00	155.00	510.00	165.00	520.00
M	over 255	2,365.00	2,365.00	2,355.00	0.00	0.00	155.00	510.00	165.00	520.00



Some of the model features, optional extras and colours shown may not be available, or may only be available in a different specification, or at a different price

<sup>1</sup>Applies to all Mercedes-Benz diesel models which do not comply with RDE (Real Driving Emissions) Step 2 Certified (Euro 6d)

<sup>2</sup>Premium rate only applicable to vehicles where the list price is over £40,000 including any factory-fitted options, standard UK delivery charge and VAT

<a href="#">Design</a>	<a href="#">Technology</a>	<a href="#">Plug-In Hybrid</a>	<a href="#">AMG Line Premium Plus</a>	<a href="#">Model prices</a>	<a href="#">Mercedes-AMG</a>	<a href="#">Mercedes-AMG prices</a>	<a href="#">Mercedes-AMG upholstery</a>	<a href="#">Personalisation</a>	<a href="#">Standard equipment</a>	<a href="#">Genuine accessories</a>	<a href="#">Technical data</a>	<a href="#">Additional information</a>
------------------------	----------------------------	--------------------------------	---------------------------------------	------------------------------	------------------------------	-------------------------------------	---	---------------------------------	------------------------------------	-------------------------------------	--------------------------------	--



# Services and insurance

## Mercedes-Benz ServiceCare

We believe that servicing costs should be as flexible and affordable as possible for your GLE, which is why we offer ServiceCare, an easy way to budget for all your servicing costs. It spreads your bills into manageable payments based on whether you have a new or used Mercedes-Benz.

With ServiceCare we guarantee the price of parts and labour for up to four services and safeguard against any further inflation. It also covers the cost of all recommended service items including brake fluid, spark plugs, air filters, fuel filters and screen wash.

You can choose either to add your servicing costs into your monthly spend or pay the full amount in a one-off payment, giving you peace of mind that they are taken care of for the period of the plan.

[Click here for more information](#)

## Warranty and breakdown cover

Every Mercedes-Benz comes with a three-year unlimited mileage warranty against manufacturing or material defects<sup>1</sup> and up to 30 years warranty against perforation due to corrosion from the inside out.<sup>2</sup> What's more, it's also covered by Mercedes-Benz Roadside Assistance – a unique package comprising up to 30 years pan-European breakdown assistance.<sup>2</sup>

## Motor Insurance

We know that once you have chosen your Mercedes-Benz you can't wait to drive it – that's why we created First Cover<sup>3</sup>. It gives you 7 days' free comprehensive Motor Insurance when you buy a new or used vehicle from a Mercedes-Benz Retailer. We will also send you a quote for annual cover, so you can enjoy the same peace of mind all year round.

[Apply for First Cover](#)

<sup>1</sup>Applies to vehicles sold by Mercedes-Benz in the UK to its franchised Retailers  
are an independent intermediary dealing with selected insurers in respect of annual insurance

<sup>2</sup>Subject to full Terms and Conditions, dependent on date of registration, available upon request

<sup>3</sup>Terms and Conditions apply. We

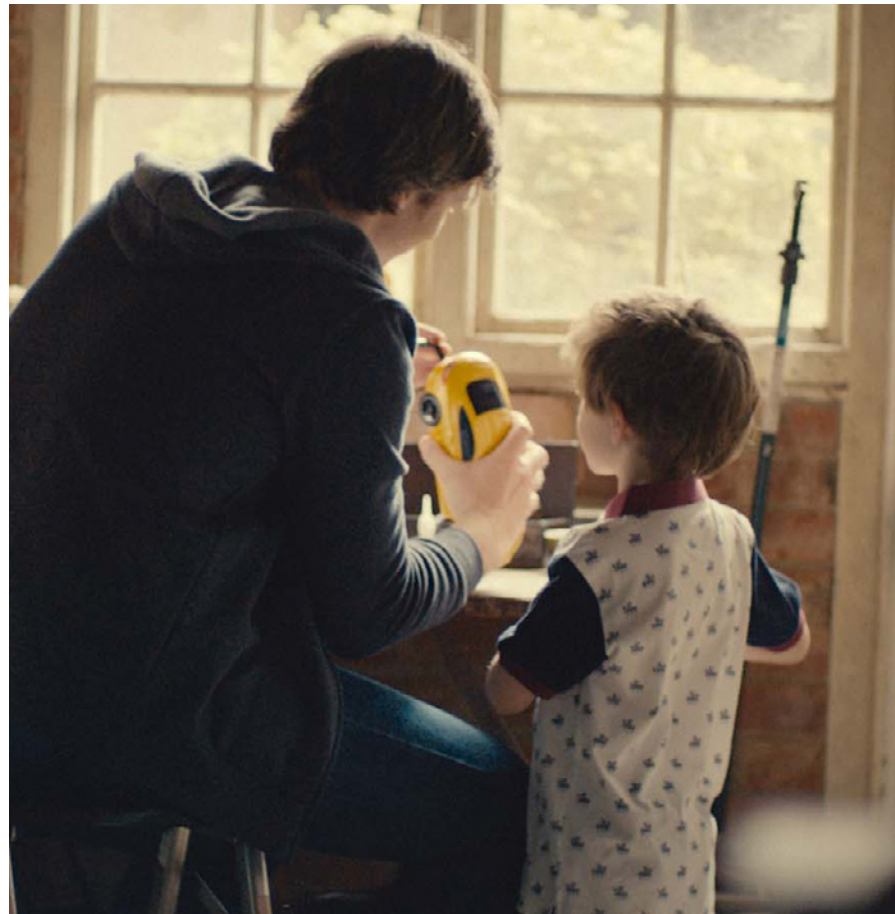





Effective from January 2022 Production. Information correct at time of publication 01.04.2022  
Prices and specifications are subject to change without prior notice.  
MBC167PL/0422 MY802.5

