

PAJERO



love that car



LOVE THAT CAR

Here at Mitsubishi, we love our cars. We love their superior quality, what they stand for, and what they're capable of. And we want you to feel the same way. It's why we strive for the highest standards in everything we do, and it's why we back all our vehicles with our Mitsubishi Diamond Advantage, Australia's Best New Car Warranty, Capped Price Servicing and Customer Care.

Mitsubishi delivers the latest and greatest in 4WD technology, style, sophistication and unquestionable reliability, giving you the confidence to go anywhere and take on almost anything. Whether you need a tough workhorse, serious off-roader or a more premium luxury model, Mitsubishi's leading range of rally-proven vehicles has the 4WD for you. Without a doubt we believe the Mitsubishi Pajero will make all other 4WDs seem second best.



OUR PROMISE

When you buy a Mitsubishi Pajero or any vehicle from our range, you're buying a vehicle that's backed by world-class research, technical innovation, and leading performance. In every area of our business we're continually focussed on four key values, we never fail to create superior vehicles that people love.



STREET PRESENCE



We'll design attention-grabbing vehicles with real street presence and genuine performance.

ADVANCED TECHNOLOGY



We'll continue to develop ground-breaking technology that focuses on better control, performance and lifestyle. This includes innovations such as our MIVEC engine technology, our intercooler-turbocharged diesel engine and our leading Mitsubishi Multi Communication System.

DRIVER CONFIDENCE



We're committed to raising the bar in terms of safety, which gives peace of mind to all occupants. Our Mitsubishi Reinforced Impact Safety Evolution (RISE) body design remains at the heart of our vehicle safety philosophy.

SUPERIOR VALUE



We'll constantly strive to deliver the ultimate customer experience at all times. This is reflected by the Mitsubishi Diamond Advantage, Australia's best new car warranty, capped price servicing and customer care, by our feature-packed vehicles, and our ongoing commitment to making our vehicles more cost effective and fuel efficient.

ADVENTUROUS PAJERO

The Mitsubishi Pajero has been part of Australia's greatest adventures since 1983. From Uluru to the Bungle Bungles, and, more importantly, back again.

The Pajero boasts advanced, powerful, fuel-efficient engines through a 3.8 litre MIVEC petrol and a powerful 3.2 litre Common Rail turbo diesel.

All Pajeros are equipped with MATT™ (Mitsubishi All Terrain Technology), and a multitude of advanced driver confidence systems.

Pajero also boasts a tough RISE (Reinforced Impact Safety Evolution) monocoque body design for outstanding protection plus the availability of safety features such as side and curtain SRS airbags, reversing sensors and reversing camera.

Every innovation has been developed so you can enjoy a better driving experience; from the hard-working GL and GLX, the stylish GLS, to the sporty VRX, and the luxury of the premium Exceed model, every Pajero delivers high levels of advanced technology and driver confidence systems.



STATE OF THE ART INTERIOR

Take a look at the luxury interior of the Pajero and ask yourself if this isn't how you want to enjoy your next on-road-off-road adventure. Everything is at your fingertips.

And your passengers will be more comfortable too, with state of the art entertainment and climate control to make long trips more enjoyable. For everyone.



MULTI-MEDIA SYSTEM

Long family drives just got shorter with a 9" full-colour panoramic screen, which includes two infrared cordless headphones so your rear passengers can watch a DVD and not bother other passengers. They can even plug into an auxiliary jack that is compatible with multi-media devices such as game consoles and digital cameras.



SPORTS INSTRUMENTATION

The Pajero boasts stylish blue illuminated dials that are aeronautically inspired.



MULTI FUNCTION DISPLAY

MITSUBISHI MULTI COMMUNICATION SYSTEM INCLUDING SATELLITE NAVIGATION AND REVERSING CAMERA

AUTO AIR CONDITIONING FRONT AND REAR CONTROLS

HEATED SEATS



ROCKFORD ACOUSTIC DESIGN™ PREMIUM AUDIO



ACTIVE
STABILITY CONTROL

PARKING SENSORS

AUDIO CONTROLS

VOICE COMMAND
CONTROLS

CRUISE CONTROL

FRONT AND REAR
POWER WINDOWS

POWER AND PERFORMANCE

The people, the journey. These are our inspiration, our driving force for the latest and greatest technology. Every next-generation innovation has been developed so that both driver and passengers enjoy an improved Pajero driving experience.

With a choice of two powerful, efficient engines, Pajero has never been better equipped for your off-road and on-road adventures.

COMMON RAIL TURBO DIESEL ENGINE

The very latest in diesel engine technology delivers power without compromise. The 3.2 litre Common Rail turbo-charged diesel yields not only next generation quietness, smoothness, fuel efficiency and emission reduction through an advanced common rail system, but delivers 147kW of power and 441Nm of grunty torque.

MIVEC ENGINE

The 3.8 litre V6 MIVEC engine (Mitsubishi Innovative Valve timing and lift Electronic Control) offers the latest technology with a lighter engine and intelligent valve timing technology to deliver improved fuel efficiency and lower emissions, while providing improved driveability. The MIVEC engine matches your driving style to minimise fuel consumption at lower revs while increasing air flow at high revs for greater performance up to an awesome 184kW.

TOWING CAPACITY

Pajero's impressive power and torque ensure you can tow your boat, caravan or trailer with supreme confidence thanks to a mammoth 3000kg* towing capacity.

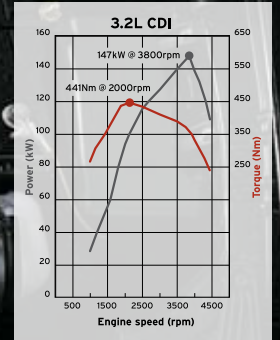

* Subject to state regulations and towbar designs. A Weight Distribution Hitch (WDH) is recommended for towball downloads exceeding 135kg. For further information, please refer to the Pajero Owner's manual.

ADVANCED TRANSMISSIONS

Pajero offers a choice of intelligent transmissions perfectly matched to your preferred driving style. A smooth-shifting 5-speed, all synchromesh manual gearbox available on the turbo diesel delivers ultimate hands-on driving experience.

Or if you prefer automatic, the INVECS II 'Smart Logic' 5-speed automatic transmission with Sports Mode mated up to the 3.8 litre V6 or the turbo diesel will be sure to provide the control you need.



MANUAL TRANSMISSION



SPORTS MODE AUTOMATIC TRANSMISSION

Sports Mode allows you to manually shift gears without using a clutch. The advantage is that this clutch-free operation reduces rev and torque loss usually associated with engaging gears, maintaining precious momentum in off-road situations.

COMPARISON OF SHIFT RESPONSE

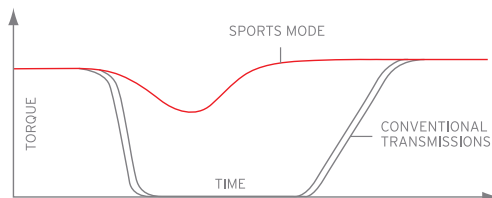

5-SPEED AUTOMATIC WITH INVECS II 'SMART LOGIC'

To provide smoother shifting, the INVECS II 'Smart Logic' transmission system's on-board computer learns and adapts to each driver's preferences by recording engine and foot braking data. The control logic then adapts the gearshift timing to suit the driver's style. You'll have effortless acceleration and a more predictable ride.

ADAPTIVE SHIFT CONTROL DURING ACCELERATION

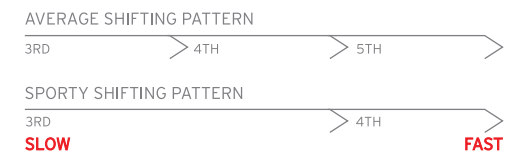

MATT: MITSUBISHI ALL TERRAIN TECHNOLOGY

All Pajero models are equipped with Mitsubishi's MATT™ (Mitsubishi All Terrain Technology) – the latest in superior 4WD technology.

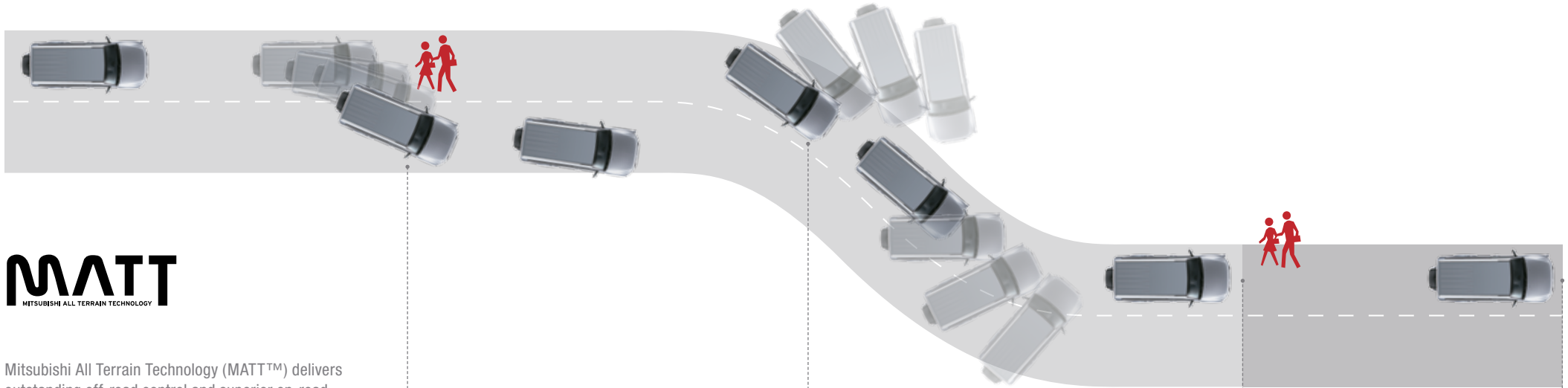

MATT
MITSUBISHI ALL TERRAIN TECHNOLOGY

Mitsubishi All Terrain Technology (MATT™) delivers outstanding off-road control and superior on-road safety and handling. MATT™ operates using intelligent sensors which constantly monitor your vehicle's wheel speeds, g-forces and yaw rates. Pajero's computer then processes this data and matches it to driver intentions via steering wheel and throttle sensors to provide optimum driving performance.

MATT™ incorporates the following advanced systems to enhance your driving control:

- Active Stability Control (ASC)
- Active Traction Control (ATC)
- Engine Brake Assist Control (EBAC)
- Super Select 4WD II
- Multi-mode Anti-lock Braking System (ABS)
- Electronic Brakeforce Distribution (EBD)
- Rear diff lock (optional)
- Mitsubishi Body Optimised Suspension (MBOS)

MULTI-MODE ANTI-LOCK BRAKING SYSTEM (ABS)

Pajero's intelligent 4-channel, 4-sensor braking system monitors wheel speeds and activates brakes to individual wheels to allow superior manoeuvring around objects under heavy braking conditions.

ACTIVE STABILITY CONTROL (ASC)

Automatically recognises under-steer and over-steer, and applies braking to the diagonal wheel to maintain stability and control through corners.

ELECTRONIC BRAKEFORCE DISTRIBUTION (EBD)

Stopping distances are reduced as EBD detects when you are carrying heavier loads and automatically increases rear-braking force.

STOPPING DISTANCE WITHOUT EBD

ACTIVE TRACTION CONTROL (ATC)

ATC prevents driving wheels from spinning by sensing loss of traction in an independent wheel and applying braking force to that wheel and sending extra power and torque to other wheels.



ENGINE BRAKE ASSIST CONTROL (EBAC)

EBAC gives you superior control on steep descents because you won't be losing engine braking and traction due to slipping wheels. This system works automatically when descending slopes in 4LLc mode.

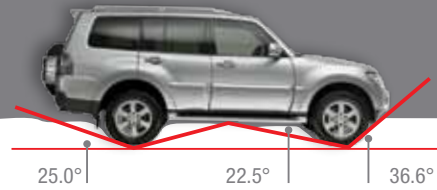

FORDING DEPTH 700mm



SUPER SELECT 4WD II

Pajero lets you alternate between 2WD and 4WD modes – the choice of around town fuel efficiency and off-road traction. You can change between modes at speeds of up to 100 kilometres per hour on any surface.



REAR DIFF LOCK

Pajero has optional rear diff lock providing superior traction for heavy duty four wheel driving. With the rear diff locked, both rear wheels receive the same amount of driving force regardless of surface to provide the maximum possible traction.

INDEPENDENT MULTI-LINK REAR SUSPENSION

Pajero boasts independent multi-links with coil springs combined with increased suspension travel and track. The result is maximum tread contact on rough terrain and a reduction in understeer.

FRONT SUSPENSION

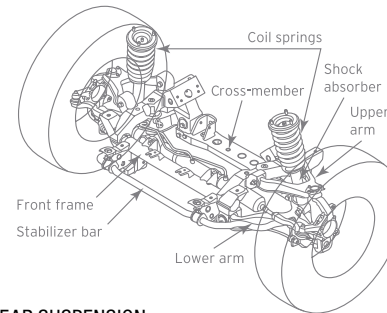

REAR SUSPENSION

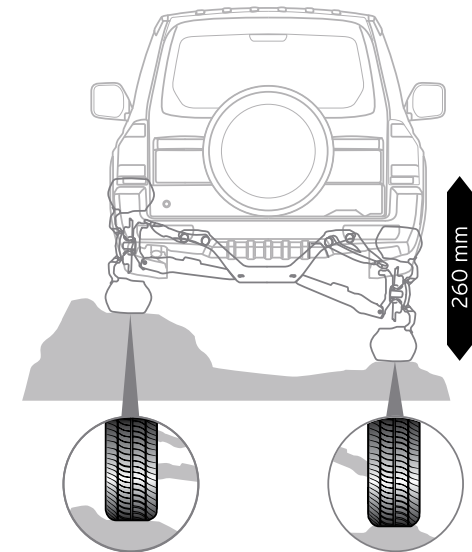
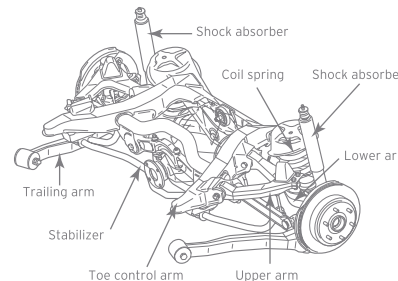

2H (2WD HIGH RANGE)

2H shifts you into rear-wheel drive for fuel-efficient performance.



4HLC (4WD HIGH RANGE WITH LOCKED CENTRE DIFFERENTIAL)

In rugged or slippery conditions, 4HLC distributes power equally to all four wheels to meet off-road challenges.



4LLC (4WD LOW RANGE WITH LOCKED CENTRE DIFFERENTIAL)

Switch to 4LLc when you need tractor-like crawling power. Maximised low-end torque pulls you through the roughest terrain.



4H (FULL-TIME 4WD)

Get added traction in 4H mode. The dynamic front/rear torque split adjusts between 33:67 and 50:50 for greater control in high-speed driving.



FOUR WHEEL VENTILATED DISC BRAKES

Large disc brakes provide better stopping power, and, combined with 17" or 18" alloy wheels, enable true off-road capability.

NEXT GENERATION TECHNOLOGY

Next-generation communications and entertainment technology have been incorporated inside the cabin to enhance your Pajero journey. Sit back and enjoy.

MITSUBISHI MULTI COMMUNICATION SYSTEM (MMCS)

MMCS gives you total control over everything you need, all in one place and all easily accessible via the 7" full colour in-dash touch screen. It really is the ultimate total control system, with:

SATELLITE NAVIGATION

Always find your way with the easy touch screen satellite navigation system. You can store frequently used addresses and search for points of interest like local restaurants, hotels or service stations.

REVERSING CAMERA

The driver's rear field of view can be seen on screen when the reverse gear is engaged. Combined with reversing sensors, it makes parking a breeze.

IPOD INTEGRATION*

While your iPod is charging in the glovebox, you can access and control all of its music through the MMCS touch screen's iPod interface.

DVD PLAYER

As you drive, the rear passengers can watch a DVD which is controlled from MMCS. When the car is stationary, DVDs can be viewed from both the front and rear seats.

AUDIO INTEGRATION WITH ROCKFORD ACOUSTIC DESIGN™ PREMIUM AUDIO SYSTEM

Getting the sound just right is easy with pre-set equaliser styles like rock, pop and jazz; you can also set your own. There are even surround sound modes to create effects such as cinema, live, club and studio for a superior audio experience.

BLUETOOTH® HANDS-FREE PHONE CONNECTIVITY

Pajero has the latest hands-free phone system technology. Bluetooth® phone connectivity is streamed through the vehicle's audio system so you can make and receive calls at the touch of a button while staying focused on the road.



*iPod device not included

ROCKFORD ACOUSTIC DESIGN™ PREMIUM AUDIO SYSTEM

Delivering a massive 860 watts with 12 surround-sound Dolby 5.1 channel speakers and an integrated 10" subwoofer which can be controlled from the steering wheel. Pajero has the sound to match its looks.

BLUETOOTH® 2.0 MUSIC STREAMING

Bluetooth® 2.0 is also integrated through the audio system and allows the driver to stream music wirelessly.



VERSATILITY



MULTI-FUNCTION DISPLAY

Actively monitoring your journey, Pajero's multi-function display can provide endless information about your environment. A barometer to help track weather conditions and keep you comfortable, an altimeter to show you how high you've climbed, a compass to point you in the right direction and average vehicle speed and fuel consumption calculations to name a few.



REAR-ENTERTAINMENT DVD SYSTEM

Why should the driver have all the fun? Pajero rear-seat passengers can enjoy sophisticated in-car entertainment with their very own DVD player and 9" full-colour screen. Game console compatible, it includes two infrared cordless headphones. As passengers watch a DVD, the rest of the car can listen to music, or simply tune out and take in the surrounding scenery.

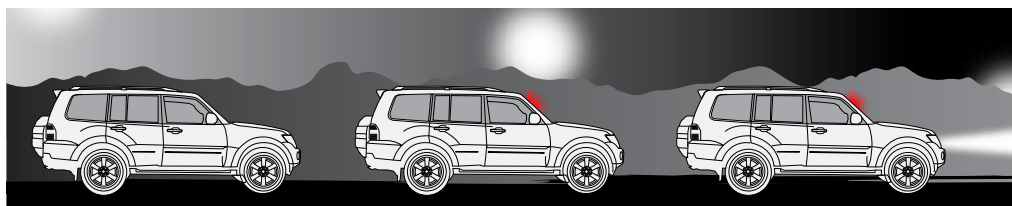

DUSK SENSING HEADLAMPS

Pajero boasts dusk sensing headlamps, which help you stay focused on the road at all times. A sensor on the windscreen automatically sends a signal to your lights and they will turn on when it gets dark or when you're travelling through a tunnel.



AUTO RAIN SENSING WIPERS

Pajero also comes equipped with premium technology like rain sensing wipers. A sensor automatically detects moisture on the windscreen and according to the amount of rain present the system will activate the wipers at the appropriate speed.

FLEXIBLE SEATING

Pajero comfortably seats seven people. The third row seats can be completely removed, or simply fold and store under the rear floor, providing greater rear cargo storage.



TECHNOLOGY DESIGNED TO SAVE LIVES

Pajero is designed with both driver and passenger safety front of mind.

RISE MONOCOQUE BODY

Mitsubishi's RISE (Reinforced Impact Safety Evolution) monocoque body system with integrated chassis is a highly rigid one-piece shell that has come through the punishing ups and downs of the world's toughest rally. In the event of an accident, the super-strength cabin's impact-absorbing crushable zones minimise impact to passengers. Reinforced critical points increase stability for handling and the RISE body also provides strength for recovery and towing.

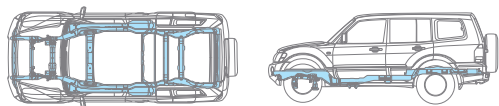

MONOCOQUE BODY INCORPORATING STRAIGHT FRAMES WITH LARGE CROSS SECTIONS

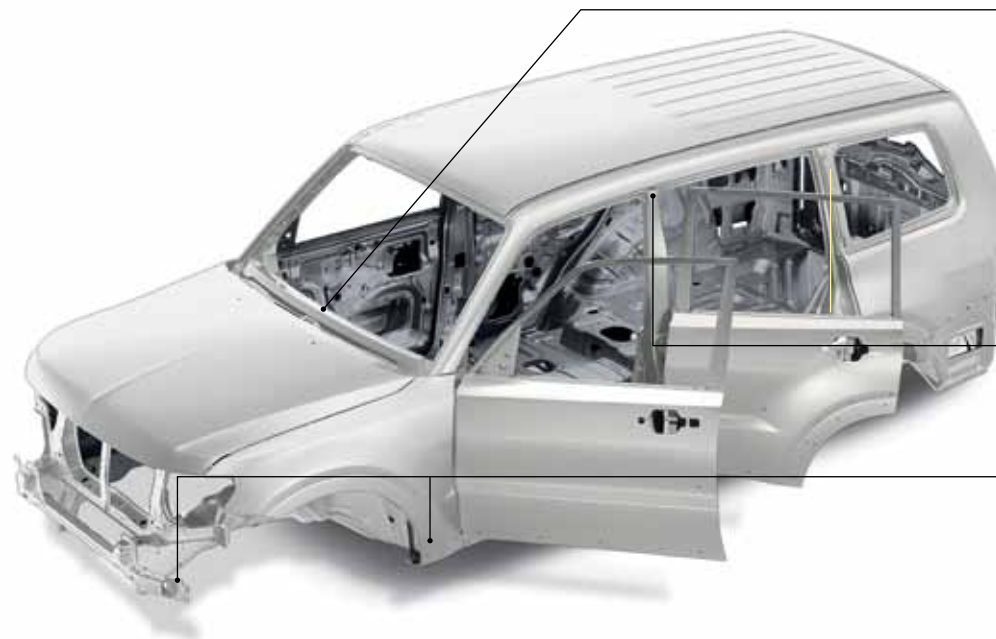

HIGH RIGIDITY DECK

The highly rigid construction of the A-pillars and deck minimises backward movement of the steering column, reducing injury to the driver.

REAR STRAIGHT FRAMES

Rear straight frames absorb energy combined with the highly rigid tailgate area to protect passengers in the rear.

LARGE BODY JOINT REINFORCEMENTS

Large reinforcements to each body joint significantly increases rigidity of joints.

CRUSHABLE ZONES

Two crushable zones in front and behind the engine absorb and dissipate collision energy.



OVERSEAS MODEL SHOWN

DRIVER AND PASSENGER SRS AIRBAGS

Standard Supplementary Restraint System (SRS) airbags on all models provide essential protection in the event of a frontal collision.

SIDE AND CURTAIN AIRBAGS

For optimal protection of driver and passengers – front and back – in the event of a side-on collision. The side airbags inflate from the side of the seat and the curtain airbags activate from the roof.

VISIBILITY CONCEPT

Mitsubishi's visibility concept combines many features to give you greater visibility while ensuring other drivers are aware of your Pajero on the road.



REVERSING CAMERA

Part of the Mitsubishi Multi Communication System, Pajero's reversing camera supports the driver's rear field of view, automatically appearing on screen when the reverse gear is engaged. It makes parking easy and offers increased safety and peace of mind when you're backing in or out of driveways.



CENTRALLY MOUNTED SPARE WHEEL

The spare wheel is centred and in a lowered position providing greater rearward visibility. Reversing sensors and a reversing camera give you confidence when reversing.



SIDE INDICATOR LIGHT

Integrated turn indicators on large exterior rear view mirrors provide greater visibility and clear indications to other road users of your actions.



HIGH INTENSITY DISCHARGE HEADLAMPS

Pajero takes visibility to the next level with High Intensity Discharge (HID) headlamps providing optimal night time visibility with a wide view and a bright, daylight-type illumination. Headlamp washers ensure maximum visibility is maintained.

MITSUBISHI DIAMOND ADVANTAGE
AUSTRALIA'S

BEST NEW CAR WARRANTY AND CUSTOMER CARE

WHEREVER YOUR ROAD TAKES YOU, WE'LL BE RIGHT THERE WITH YOU.
IT'S PART OF OUR COMMITMENT TO ENSURING YOU ENJOY COMPLETE DRIVING
PLEASURE WHENEVER YOU GET BEHIND THE WHEEL OF YOUR MITSUBISHI.
NOTHING DEMONSTRATES THIS COMMITMENT BETTER THAN OUR

UNIQUE DIAMOND ADVANTAGE CUSTOMER CARE PACKAGE.

10 | **5**
YEAR | YEAR
**MITSUBISHI
DIAMOND
ADVANTAGE**
AUSTRALIA'S BEST
NEW CAR WARRANTY!
CAPPED PRICE SERVICING
AND CUSTOMER CARE*

WARRANTY 10/5YR	CUSTOMER ASSIST 24/7	5YR ROADSIDE ASSIST	CAPPED PRICE SERVICING	GENUINE SERVICE	GENUINE PARTS	200+ DEALER NETWORK	FINANCE	INSURANCE
Mitsubishi Motors Australia Limited offers a 10 year/160,000km (whichever comes first) non-transferable Powertrain Warranty, a 5 year/130,000km (whichever comes first) New Vehicle Warranty and a 5 year Perforation Corrosion Warranty on all Mitsubishi cars and light commercial vehicles. Service conditions apply. See your dealer for details.	We're here to help, 24 hours a day, seven days a week. So just call Mitsubishi Motors Australia Customer Assistance Centre on 1300 13 12 11 if you have any questions, or for the location of your nearest Mitsubishi Dealer.	Peace of mind is guaranteed anywhere in Australia with our free 5 year/130,000km (whichever comes first) Roadside Assist, 24 hours a day, 365 days a year. Our fast, comprehensive roadside service offers assistance, repairs, towing and storage. Our Premium Roadside Assist clients also enjoy the added benefits of accommodation, medical and transport facilities. Service conditions apply.	Enjoy 'no surprises' certainty when you book your Mitsubishi in for its regular service requirements. Your servicing costs will be capped for the first 4 years or 60,000km of driving, whichever occurs first up to the first four Regular Services and eight Regular Services for Ralliart and Lancer Evolution vehicles. Conditions apply.	Mitsubishi offers one of Australia's best service intervals of 12 months/15,000 km (whichever comes first). Regular scheduled servicing ensures the long-term reliability and safety of your Mitsubishi and our Scheduled Service Program also helps protect your car's resale value.	Your Mitsubishi will be serviced regularly by skilled Mitsubishi-trained technicians. Only genuine Mitsubishi parts are fitted to your car during scheduled servicing – parts that have been fully tested and meet Mitsubishi's stringent quality control. All these parts carry the Mitsubishi Genuine Parts 12 months/20,000 km (whichever comes first) guarantee.	With a network of more than 200 dealers, Mitsubishi is never too far away.	Take the burden out of financing your new Mitsubishi vehicle with our competitive range of finance products, developed by Mitsubishi Motors Australia Limited and St. George Motor Finance Limited.	With the sound backing of Swann Insurance and Mitsubishi Motors Australia Limited, Mitsubishi owners can choose between vehicle and personal protection solutions including motor vehicle, gap cover and loan protection insurance as well as a range of tailored warranty policies.



†10 year or 160,000km Powertrain Warranty (whichever comes first) (non transferable). 5 year or 130,000km New Vehicle Warranty (whichever comes first).
^5 year or 130,000km Roadside Assist (whichever occurs first). Service conditions apply. *4 year or 60,000km Capped Price Servicing (whichever comes first).
Conditions apply. See your Dealer for full details.

11MY December 2010

mitsubishi-motors.com.au

Specifications and features may vary by model. Please refer to the Specifications Booklet enclosed or mitsubishi-motors.com.au for full information.
As features can change without notice, confirm the equipment level of your vehicle with your Mitsubishi dealer. paj1103. MIT4148.



PAJERO

SPECIFICATIONS & FEATURES



love that car



MITSUBISHI PAJERO – KEY FEATURES BY MODEL



Pajero GL

Engine

3.2L High Power Common Rail Direct Injection Diesel

Mechanical

5 speed manual transmission
5 speed Sports Mode automatic transmission (optional) with INVECS II Smart Logic
Super Select 4WD II (Full Time 4WD including selectable 2WD mode)
Centre differential with viscous coupling unit
Synchronised auto front free wheeling differential
Power steering
Front & rear recovery points
Front skid plate
Fuel tank protector

Exterior

17" steel wheels
Body coloured wheelarch flares
Body coloured bodyside and tailgate cladding
Rear fog lamp
Secure sports spare wheel cover
Front and rear mud guards

Interior

Carpet floor covering

Comfort

Climate control air conditioning with digital display
Rear seat heater ducts
Pollen filter
Tilt adjustable steering column
Side and rear window demisters
Cabin mood lighting

Convenience

Cruise Control
Central locking (including tailgate) with remote keyless entry

Power windows – front and rear (driver auto-down function)
Power door mirrors with fold control
Variable intermittent windscreen wipers
Intermittent rear wiper and washer
Accessory power sockets (3)
Front map lamps
Cargo room lamp
Rear passenger reading lamps
High-rise front centre armrest with forward adjustable slide position
Retractable passenger assist handles (6)
Sunvisor with ticket holder and vanity mirror
Remote fuel filler release

Storage

Glove box with shelf – illuminated and lockable
Centre storage console with upper and lower compartments
Door pockets – front and rear
Cup holders (6)
Sunglass pocket
Luggage tie-down hooks (4)
Seat back pocket – passenger
Underfloor storage compartment

Seating

Fabric seat trim
Front & rear seats fold flat
Front seats
Slide, recline and dual height adjuster for driver's seat
Height and tilt adjustable headrests
Access support grips (2)
Second row seats
60:40 split folding function
Centre armrest with cupholders
Height adjustable headrests

Audio & Media

Electronic tune AM/FM radio/CD/MP3 player
6 speakers
Audio input jack
Multi-function display – trip computer, compass, altimeter, barometer, outside temperature, date and time

Safety

Driver and passenger SRS airbags
Side and curtain SRS airbags
Active Stability Control (ASC)
Multi-mode Anti-lock Braking System (ABS) with Electronic Brakeforce Distribution (EBD)
Active Traction Control (ATC)
Engine Brake Assist Control (EBAC)
Reinforced Impact Safety Evolution (RISE) body
Side door impact beams
Front seatbelt pretensioners & force limiters
Child proof rear door locks
Child restraint anchor points (3)
High mount stop lamp on rear door
Seatbelt warning buzzer

Security

Theft protection alarm
Anti-theft encrypted engine immobilisation
Auto relock function for central door locking
Cabin illumination on unlock and key removal
Diamond Advantage Roadside Assistance – 5 years

Options

Rear diff lock



Pajero GLX (Features Additional to GL)

Exterior

17" 7-spoke alloy wheels
Roof rails

Interior

Leather bound steering wheel
Leather bound gearshift knob, transfer lever, and park brake lever

Convenience

Steering wheel audio controls

Audio & Media

USB input

Seating

Third row seats
Front facing reclining bench seat (3rd row seats)
Folding stow away function – folds flat into underfloor compartment
Removable and height adjustable headrests

Options

Rear diff lock



Pajero GLS (Features Additional to GLX)

Engine

3.2L High Power Common Rail Direct Injection Diesel
or
3.8L V6 MIVEC engine

Mechanical

5 speed manual transmission (Diesel only)
5 speed Sports Mode automatic transmission (optional)
with INVECS II Smart Logic

Exterior

Body coloured door mirrors
Body coloured door handles
Front fog lamps
Chrome grille
Side steps
Privacy glass

Interior

Titanium look power window switch surrounds
Chrome inner door handles

Comfort & Convenience

Front and rear zone air conditioning controls
Rear mounted air conditioning ducts
Sunvisor with extensions and illuminated vanity
mirrors with lid (driver side ticket holder)

Audio & Media

In-dash 6 CD changer
Bluetooth® hands free phone connectivity with
voice command¹
Bluetooth® 2.0 wireless data transfer²

Safety & Security

Auto dimming rear-view mirror
Reverse parking sensors
Retractable cargo blind

Options

Rear diff lock (Diesel only)
Rear seat entertainment package with remote control
and headphones (1 set)
Rear seat entertainment package + rear diff lock



Pajero VRX (Features Additional to GLS)

Exterior

18" 6-spoke alloy wheels
Body coloured door mirrors with integrated indicator light
Front skid plate silver
Front grille with chrome accents
Rear roof spoiler

Interior

Aluminium print decoration panel and air conditioning
outlets
Sports style high contrast binnacle
Aluminium sports pedals

Seating

Sports cloth and leather seat trim
Power driver seat with 8-way adjustment and lumbar
adjustment
Power passenger seat with 4-way adjustment
Heated seat warmers

Audio & Media

Rockford Acoustic Design™ premium 860 Watt audio
12 speakers including subwoofer
Rear seat entertainment system with remote control
and 2 headphones

Safety

Exterior rear view mirror demister
High Intensity Discharge (HID) headlamps with
automatic levelling
Headlamp washers
Dusk sensing headlamps
Rain sensing wipers

Options

Mitsubishi Multi Communication System (MMCS)²
– includes satellite navigation, reversing camera
and iPod control.

Adventure Pack (Diesel only)
17" alloy wheels and rear diff lock

Adventure Navigation Pack (Diesel only)
17" alloy wheels and rear diff lock
Mitsubishi Multi Communication System (MMCS)²
– includes satellite navigation, reversing camera
and iPod control.



Pajero Exceed (Features Additional to VRX)

Exterior

18" 10-spoke alloy wheels
Chrome door mirrors with integrated indicator light
Chrome door handles
Chrome side protection moulding strips
Chrome grille
Chrome fog lamp bezels

Interior styling

Wood and leather steering wheel
Walnut woodprint panel
Matching carpet mats

Storage

Glovebox compendium

Seating

Leather seat facings (leather look on 3rd row seats)

Audio

iPod control

Media

Mitsubishi Multi Communication System (MMCS)²
– includes satellite navigation and reversing camera

Safety

Reversing camera (included in MMCS)

Security

Premium security sensor alarm with siren
Diamond Advantage Premium Roadside Assistance
– 5 years

Options

Electric sunroof with slide and tilt (rear seat
entertainment system and sunglass pocket deleted)

Adventure Pack (Diesel only)
17" alloy wheels and rear diff lock

¹Bluetooth® phone connectivity depends on your phone compatibility.

²When MMCS is fitted, USB input, 6 CD changer, and Bluetooth® 2.0 wireless data transfer functionality is deleted. Navigation voice recognition commands replace Bluetooth® voice recognition commands.

PAJERO SPECIFICATIONS

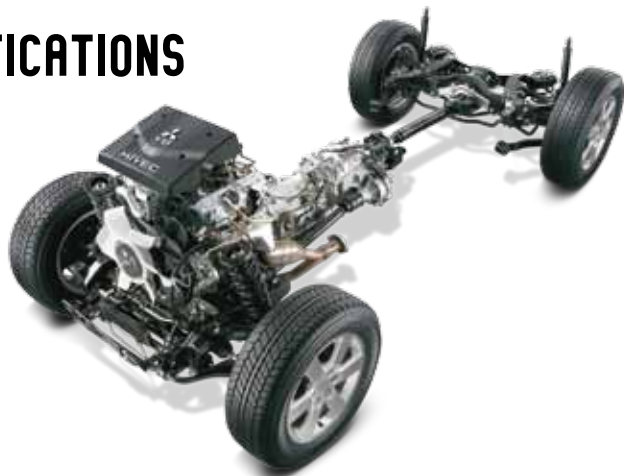

	Engine – Petrol	Engine – Diesel	
Type	3.8L V6 SOHC 24-valve MIVEC	3.2L CDI DOHC 16-valve intercooled turbo diesel	
Bore x Stroke	95.0mm x 90.0mm	98.5mm x 105.0mm	
Capacity	3,828cm ³	3,200cm ³	
Compression ratio	9.8:1	16.0:1	
Fuel system	ECI multi-fuel injection – LPG compatible	Electronic direct injection fuel pump / Turbocharger with intercooler	
	A/T	M/T	A/T
Maximum power	184kW @ 6000rpm	147kW @ 3800rpm	147kW @ 3800rpm
Maximum torque	329Nm @ 2750rpm	441Nm @ 2000rpm	441Nm @ 2000rpm

Engine Electrical		
	3.8L V6	3.2L CDI
Battery	75D23L	80D26L
	520 CCA/118 RC	622 CCA/159 RC
Voltage	12V	12V
Alternator	120 AMP	120 AMP
Starter motor	1.4kW	2.2kW

Brakes	
Front brakes	Ventilated discs
Rear brakes	Ventilated discs
Suspension	
Front	Independent – double wishbone coil spring and stabiliser bar
Rear	Independent – multi-link coil spring and stabiliser bar
Mechanical	
Manual clutch	Single dry plate with hydraulic actuation
Automatic clutch	3 element torque converter with lock-up

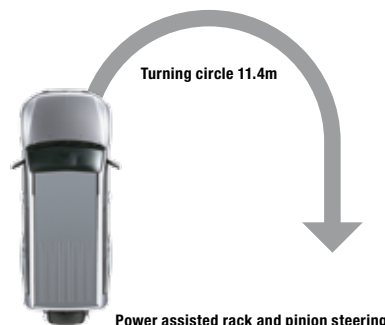

Transmission			
5-speed manual transmission			
5-speed automatic transmission with "Sports Mode" sequential style shift change and INVECS II 'Smart Logic'			
	3.8L V6 A/T	3.2L CDI M/T	3.2L CDI A/T
Gear ratio			
– first	3.789	4.234	3.520
– second	2.057	2.238	2.042
– third	1.421	1.398	1.400
– fourth	1.000	1.000	1.000
– fifth	0.731	0.760	0.716
– reverse	3.865	3.553	3.224
Transfer ratio			
– high	1.000	1.000	1.000
– low	1.900	1.900	1.900
Final drive gear ratio	4.300	3.917	3.917

Fuel Consumption ¹	
(ADR81/02) (Litres per 100 kms) combined	
3.8L A/T	13.5
3.2D M/T	8.4
3.2D A/T	9.0
Fuel tank capacity (L)	88

Four Wheel Drive Clearances	
Ground clearance	225mm
Fording depth	700mm
Approach angle (°)	36.6°
Ramp breakover angle (°)	22.5°
Departure angle (°)	25.0°
Climbing angle (°)	35.0°

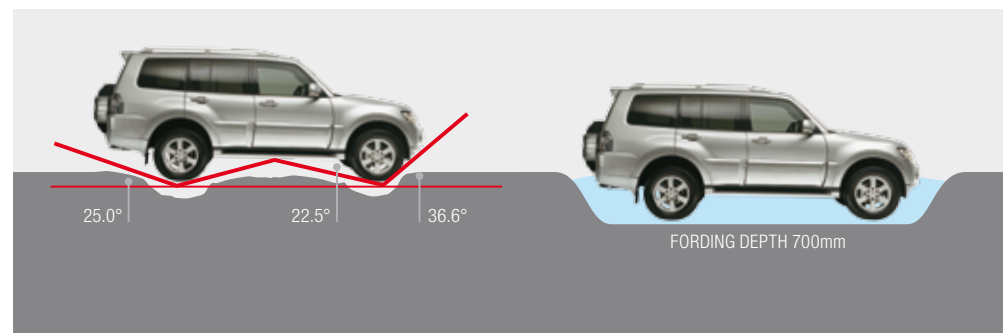

Models	Wheels	Tyres ²
GL	17" x 7.5" steel wheels	265/65R-17 112H
GLX / GLS	17" x 7.5" 7-spoke alloy wheels	265/65R-17 112H
VRX	18" x 7.5" 6-spoke alloy wheels	265/60R-18 110H
Exceed	18" x 7.5" 10-spoke alloy wheels	265/60R-18 110H
All models	Matching spare wheel with wheel lock nut	

PAJERO SPECIFICATIONS



Seating capacity: Up to 7

Capacities	GL	GLX	GLS	VRX	EXCEED
Gross Vehicle Mass (kg)					
3.8L V6 A/T	–	–	2,920	2,920	2,920
3.2L CDI M/T	3,030	3,030	3,030	–	–
3.2L CDI A/T	3,030	3,030	3,030	3,030	3,030
Kerb Mass (kg)					
3.8L V6 A/T	–	–	2,226	2,226	2,252
3.2L CDI M/T	2,280	2,283	2,331	–	–
3.2L CDI A/T	2,270	2,273	2,331	2,324	2,350
Payload³ (kg)					
3.8L V6 A/T	–	–	694	694	668
3.2L CDI M/T	743	747	699	–	–
3.2L CDI A/T	753	757	699	706	680

Luggage Area (mm)	
Length – 2nd row seat folded and 3rd row seat stowed	1,430
Length – 2nd row seat upright and 3rd row seat stowed	850
Length – 2nd and 3rd row seat upright	170
Width	1,395
Width at wheel arches	1,030
Luggage area floor height	1,110
Load floor height (from ground)	740
Cargo load space 2nd/3rd row flat	1,789 (Exceed 1,758) litres
Cargo load space 3rd row flat	1,081 (Exceed 1,050) litres

Front	955
2nd row	916
3rd row headroom	860
Front	895
2nd row	820
3rd row	750

Exterior Dimensions (mm)	
Overall height	1,900
Overall length	4,900
Overall width	1,875
Track – front	1,570
Track – rear	1,570
Wheelbase	2,780



Gross Combination Mass (kg)	
3.8L V6 A/T	5,920
3.2L CDI M/T	6,030
3.2L CDI A/T	6,030
Maximum Front Axle Load (kg)	
3.8L V6	1,300
3.2L CDI	1,330
Maximum Rear Axle Load (kg)	
All models	1,780
Maximum Roof Load (kg)	
All models	100

Maximum Towing Capacity ⁴	
With trailer brakes (kg)	3,000
Without trailer brakes (kg)	750
Maximum towball download (kg) when towed weight is greater than 2,500kg	180
Maximum towball download (kg) when towed weight is 2,500kg or less	250

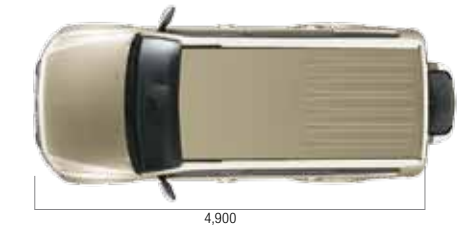

¹ These figures are obtained from controlled laboratory tests conducted by Mitsubishi Motors to Australian Design Rule ADR81/02 and are provided to assist you in comparing the fuel consumption of Pajero with other vehicle's. The actual fuel consumption you achieve will depend, however, on many factors, including your driving habits, the prevailing conditions and your vehicles equipment, condition and use.

² The tyres fitted to Pajero as standard equipment are designed primarily for use on sealed roads. If your Pajero is to be driven primarily on unsealed roads, please consult your Mitsubishi dealer for advice on suitable tyre choices.

³ Payload includes occupants, fuel and fitted options (if any). The weight of these must be deducted from payload to determine actual load carrying capacity. Front and/or rear axle loads must not be exceeded.

⁴ Subject to state regulations and towbar designs. A Weight Distribution Hitch (WDH) is recommended for towball downloads exceeding 135kg. For further information, please refer to the Pajero owner's manual.

STYLE YOUR PAJERO

Colours



COOL SILVER (M)



WHITE



BLACK (P)



GRAPHITE GREY (M)



SAPPHIRE (P)



RED (M)



CHAMPAGNE (M)



IRONBARK (M)



WARM WHITE (P)

Trims



GL/GLX/GLS – FABRIC



VRX – SPORTS CLOTH & LEATHER



EXCEED – DAKAR LEATHER



EXCEED – PARIS LEATHER

	GL	GLX	GLS	VRX	EXCEED	
	FABRIC	FABRIC	FABRIC	SPORTS CLOTH & LEATHER	DAKAR LEATHER	PARIS LEATHER
COOL SILVER (M)	✓	✓	✓	✓	✓	–
WHITE	✓	✓	✓	✓	✓	✓
BLACK (P)	✓	✓	✓	✓	✓	✓
GRAPHITE GREY (M)	✓	✓	✓	✓	✓	–
CHAMPAGNE (M)	✓	✓	✓	✓	✓	✓
RED (M)	–	–	✓	✓	✓	–
IRONBARK (M)	–	–	✓	✓	✓	✓
SAPPHIRE (P)	–	–	–	✓	✓	–
WARM WHITE (P)	–	–	–	✓	✓	✓

Metallic (M) and pearlescent (P) paints are optional extra.

10 **MITSUBISHI**
DIAMOND
ADVANTAGE **5**
AUSTRALIA'S BEST
NEW CAR WARRANTY,
CAPPED PRICE SERVICING
AND CUSTOMER CARE

NOW INCLUDING CAPPED PRICE SERVICING*
WARRANTY 10/5 YEAR ♦ **5 YEAR ROADSIDE ASSIST** ♦ **CUSTOMER ASSIST 24/7** ♦ **200+ DEALER NETWORK**
♦ **GENUINE SERVICE** ♦ **GENUINE PARTS** ♦ **INSURANCE** ♦ **FINANCE** ♦ **PRE-OWNED VEHICLES**

*10 year or 160,000km Powertrain Warranty (whichever comes first) (non transferable). *5 year or 130,000km New Vehicle Warranty (whichever comes first). *5 year or 130,000km Roadside Assist (whichever occurs first). Service conditions apply. †4 year or 60,000km Capped Price Servicing (whichever comes first) Covers all items specified under the standard 'Maintenance for Normal Operating Conditions' schedule detailed in the Service and Warranty Booklet. Additional service/repair items (if required) are at additional cost. Excludes Government and Rental Fleet Customers. See your Dealer for full details.



Always consult your authorised Mitsubishi Dealer for the latest details on specifications, options, prices, availability and conditions on New Vehicle Warranty. All product illustrations and specifications referred to herein are believed to be correct at the time of publication approval. Subject to any applicable Federal, State or Territory Laws or ordinances, which may apply from time to time, Mitsubishi Motors Australia Limited reserves the right, without notice, or obligation, to discontinue or make changes to designs, specifications, colours and materials of the options and products referred to herein at any time without incurring any liability to any purchaser thereof. ©Mitsubishi Motors Australia Limited. ABN 53 007 870 395. paj1012. MIT3879.

11 MY December 2010

PAJERO

GENUINE ACCESSORIES



PAJERO

love that car



PERSONALISE YOUR VEHICLE

From the alloy nudge bar to the rear seat entertainment system, Mitsubishi has the accessories to suit your individual needs.

Mitsubishi Genuine Accessories go through an extensive program of design, development and testing to ensure they meet all applicable government standards as well as Mitsubishi's own rigorous engineering specifications and performance targets.

Using Mitsubishi Genuine Accessories will ensure you get the best quality accessories that are both as durable and reliable as you should expect.

Ask your Mitsubishi dealer for the complete list and pricing of accessories available for your new Pajero.



Bonnet Protector - Also Available Tinted



Headlamp Protector

Sun Shades



Alloy Nudge Bar



Front Skid Plate



Fog Lamps



Fog Lamp Protector



Bumper Protector



Steel Front Protection Bar



Alloy Front Protection Bar



Water Craft Carrier

Chrome Mirror Covers

Bike Carrier

Bonnet Protector

Sports Mesh Grille

Side Step Illumination

Bumper Protector

Fog Lamps

Fog Lamp Protectors

Headlamp Protector



Weathershields

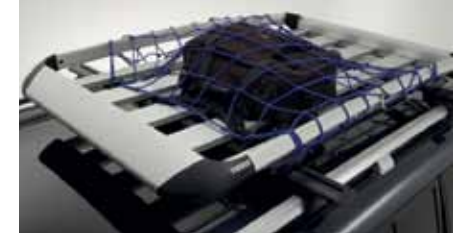

Luggage Carrier & Net



Luggage Pod



Roof Rack Cross Bars



Ski Carrier



Chrome Exhaust Tip



Rear Spoiler



Rear Reversing Mirror



Rear Dust Deflector



Side Steps

INTERIOR



MMCS With Optional Reversing Camera



Reversing Mirror/Camera



MMCS With Satellite Navigation



Ipod Adapter For MMCS



Additional Headsets



Rear Seat Entertainment

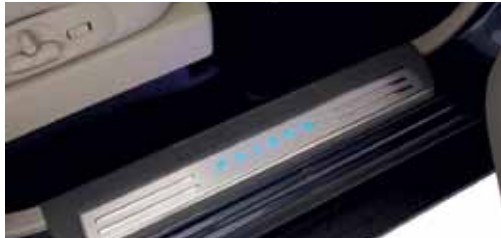

Outer Scuff Plates (Illuminated) – Front



Outer Scuff Plates – Rear



Alloy Sports Pedals



Towbar Hitch Cover Plate



Bluetooth® Hands Free Kit



Seat Covers (Neoprene)



Boot Flap Scuff Guard



Carpet Mats



Dash Mat



Rear Cargo Blind



Cargo Carpet Mat



Half Cargo Liner



Cargo Liner



Cargo Barrier



Cargo Net & Cargo Mat



Non Slip Boot Grip Net

When Genuine Accessories are fitted to your new vehicle at the time of delivery, they are covered by the Mitsubishi 3 year/130,000km (whichever comes first) Accessory Warranty. When they are fitted after purchase of your new vehicle they are covered for the remainder of the Accessory Warranty or for 12 months/20,000km, whichever is the longer. In the case of Diamond Spectrum Accessories the warranty is 12 months/20,000km (whichever comes first). ^Diamond Spectrum Accessories. Pictures shown for illustration purposes and may not be product specific. Please check with your Mitsubishi dealer for specific model applications. apaj1009 MIT3878

11MY August 2010

DIAMOND
GENUINE PARTS
ADVANTAGE