

do™ one
better

LIBERTY
2018



SUBARU



Do one better.
Find out more at www.subaru.com.au/liberty



Liberty 3.6R

do one better

The new Subaru Liberty is made to make you feel good. Your island amid a sea of chaos. Sink into super comfortable seats, switch on the ignition and begin each day with precision performance.

Sophisticated and spacious, the new Liberty is a smooth ride. Unwind while winding your way to work, with sharp cornering and responsive handling. Mute your commute in a quiet and comfortable cabin, or turn up the volume with Apple CarPlay™ and Android Auto™ connectivity¹.

The new Liberty makes you look good too. It's armed with charm, 18" alloys and updated Euro styling.

1. Compatible Apple or Android device required.



Liberty 2.5i

do the smart sedan

Getting to work won't feel like work, with Subaru's much envied world-class engineering, incredible handling and intuitive technology.

Enjoy superb grip, supreme confidence and another pair of eyes on the road with Subaru's cutting edge EyeSight® Driver Assist technology, which includes Lane Keep Assist. Add a reverse camera and power folding mirrors and you've got one smart sedan.

The Subaru Liberty 2.5i is the sedan for modern living. Everything is easy. A large touchscreen, seamless connectivity, extra charging ports in the back and dual zone climate control.

Stay ahead of the curve with Symmetrical All-Wheel Drive, rain-sensing windscreen wipers and LED daytime running lights. Smarter, classier, better.

Liberty 2.5i features

Performance

- + 2.5-litre horizontally-opposed Boxer petrol engine
- + Lineartronic™ CVT with manual mode
- + Maximum power output: 129kW@5800rpm
- + Maximum torque: 235Nm@4000rpm
- + SI-Drive – 2 modes

Interior

- + Air-conditioning – dual zone climate control with rear vents
- + Cloth seat trim – choice of black or ivory
- + Leather¹ gear shift and steering wheel
- + Manual seat height lifter – driver
- + One touch lane change indicator
- + 60/40 split folding rear seats
- + USB charge port – rear passengers (x2)
- + Sports pedals

Exterior

- + 18" alloy wheels with full size spare
- + Door mirrors with indicators – power folding
- + LED daytime running lights and front fog lights
- + Halogen headlights with auto off (dusk-sensing)
- + Rain-sensing windscreen wipers
- + Rear door and rear quarter privacy glass

Entertainment/Technology

- + Multi-Information Display unit (MID)
- + Integrated infotainment system with 6.5" LCD touchscreen
- + Bluetooth®² wireless technology
- + Rear view reverse camera
- + Auto door lock/unlock

- + Auxiliary jack and USB connection
- + Apple CarPlay™ and Android Auto™ connectivity³
- + EyeSight® Driver Assist system featuring:
 - + Adaptive Cruise Control
 - + Brake Light Recognition
 - + Lane Departure Warning
 - + Lane Keep Assist
 - + Lane Sway Warning
 - + Lead Vehicle Start Alert
 - + Pre-Collision Brake Assist
 - + Pre-Collision Braking System
 - + Pre-Collision Steering Assist
 - + Pre-Collision Throttle Management

1. Some parts of the seating or trim are not full natural leather. 2. Bluetooth® is a registered trademark of Bluetooth SIG Inc. System operation ability is subject to Bluetooth® wireless technology specification of individual device. 3. Compatible Apple or Android device required.

well to do

Live life in the class lane with a larger 8" touchscreen, heated front leather¹ seats and more safety features. The Subaru Liberty 2.5i Premium includes satellite navigation, an electric sunroof and Steering Responsive Headlights. It also comes with a Side View Monitor, Front View Monitor and Adaptive Driving Beam as part of Subaru's Vision Assist technology.

Liberty 2.5i Premium features

Performance

- + 2.5-litre horizontally-opposed Boxer petrol engine
- + Lineartronic™ CVT with manual mode
- + Maximum power output: 129kW@5800rpm
- + Maximum torque: 235Nm@4000rpm
- + SI-Drive – 2 modes

Interior

- + Air-conditioning – dual zone climate control with rear vents
- + Leather¹ seat trim – choice of black or ivory
- + Leather¹ gear shift and steering wheel
- + 8-way power seats – driver and front passenger (driver with dual memory)
- + One touch lane change indicator
- + 60/40 split folding rear seats
- + Electric lumbar support – driver
- + USB charge port – rear passengers (x2)
- + Sports pedals
- + Smart key and push-start ignition

- + Auto-dimming rear view mirror
- + Heated front seats

Exterior

- + 18" alloy wheels with full size spare
- + Door mirrors with indicators – heated and power folding
- + Self-levelling LED headlights with auto off (dusk-sensing)
- + LED daytime running lights and front fog lights
- + Rain-sensing windscreen wipers
- + Rear door and rear quarter privacy glass
- + Electric sunroof
- + Steering Responsive Headlights (SRH)

Entertainment/Technology

- + Multi-Information Display unit (MID)
- + Integrated infotainment system with 8" LCD touchscreen
- + Satellite navigation
- + Bluetooth^{®2} wireless technology
- + Rear view reverse camera

- + Auto door lock/unlock
- + Auxiliary jack and USB connections (x2)
- + Apple CarPlay™ and Android Auto™ connectivity³
- + EyeSight[®] Driver Assist system featuring:
 - + Adaptive Cruise Control
 - + Brake Light Recognition
 - + Lane Departure Warning
 - + Lane Keep Assist
 - + Lane Sway Warning
 - + Lead Vehicle Start Alert
 - + Pre-Collision Brake Assist
 - + Pre-Collision Braking System
 - + Pre-Collision Steering Assist
 - + Pre-Collision Throttle Management
- + Siri[®] compatibility
- + Vision Assist featuring:
 - + Adaptive Driving Beam (ADB)
 - + Blind Spot Monitor (BSM)
 - + Front View Monitor (FVM)
 - + Lane Change Assist (LCA)
 - + Rear Cross Traffic Alert (RCTA)
 - + Side View Monitor (SVM)

Well to do.

Explore the range at www.subaru.com.au/liberty

1. Some parts of the seating or trim are not full natural leather. 2. Bluetooth[®] is a registered trademark of Bluetooth SIG Inc. System operation ability is subject to Bluetooth[®] wireless technology specification of individual device.

3. Compatible Apple or Android device required.



Liberty 2.5i Premium



Liberty 3.6R

do the superior interior

Treat yourself to the ultimate in luxury and style. More chrome, more stereo and more power. Everything is more fun with an epic six-cylinder Boxer engine, SI-Drive including Sport Sharp (S#) driving mode and 11 harman kardon^{®1} speakers, subwoofer and amplifier.

Liberty 3.6R features

Performance

- + 3.6-litre horizontally-opposed Boxer petrol engine
- + Lineartronic[™] CVT with manual mode
- + Maximum power output: 191kW@6000rpm
- + Maximum torque: 350Nm@4400rpm

Interior

- + Air-conditioning – dual zone climate control with rear vents
- + Leather² seat trim – choice of black or ivory
- + Leather² gear shift and steering wheel
- + 8-way power seats – driver and front passenger (driver with dual memory)
- + One touch lane change indicator
- + 60/40 split folding rear seats
- + Electric lumbar support – driver
- + USB charge port – rear passengers (x2)
- + Sports pedals
- + Smart key and push-start ignition
- + Auto-dimming rear view mirror
- + Heated front seats

Exterior

- + 18" alloy wheels with full size spare
- + Door mirrors with indicators – heated and power folding
- + Self-levelling LED headlights with auto off (dusk-sensing)
- + LED front fog lights and daytime running lights
- + Rain-sensing windscreen wipers
- + Rear door and rear quarter privacy glass
- + Electric sunroof
- + Chrome type rear garnish
- + Chrome type side skirt garnish and door handle inserts
- + Dual tail pipes

Entertainment/Technology

- + Multi-Information Display unit (MID)
- + Integrated infotainment system with 8" LCD touchscreen
- + Satellite navigation
- + 11 harman kardon^{®1} speakers with subwoofer and amplifier

- + Bluetooth^{®3} wireless technology
- + Rear view reverse camera
- + Auxiliary jack and USB connections (x2)
- + Apple CarPlay[™] and Android Auto[™] connectivity⁴
- + EyeSight[®] Driver Assist system featuring:
 - + Adaptive Cruise Control
 - + Brake Light Recognition
 - + Lane Departure Warning
 - + Lane Keep Assist
 - + Lane Sway Warning
 - + Lead Vehicle Start Alert
 - + Pre-Collision Brake Assist
 - + Pre-Collision Braking System
 - + Pre-Collision Steering Assist
 - + Pre-Collision Throttle Management
- + Siri[®] compatibility
- + Vision Assist featuring:
 - + Adaptive Driving Beam (ADB)
 - + Blind Spot Monitor (BSM)
 - + Front View Monitor (FVM)
 - + Lane Change Assist (LCA)
 - + Rear Cross Traffic Alert (RCTA)
 - + Side View Monitor (SVM)

1. harman kardon[®] is a registered trademark of HARMAN International Industries, Incorporated. 2. Some parts of the seating or trim are not full natural leather. 3. Bluetooth[®] is a registered trademark of Bluetooth SIG Inc. System operation ability is subject to Bluetooth[®] wireless technology specification of individual device. 4. Compatible Apple or Android device required.

do without nothing

Subaru Liberty puts smart infotainment at your fingertips. Liberty delivers the ultimate in control with an integrated infotainment display that lets you make handsfree calls and play tracks via voice and touchscreen functionality. A rear view reverse camera keeps the family safe, while Liberty 2.5i Premium and Liberty 3.6R feature satellite navigation.



Infotainment system
Liberty 2.5i Premium
and 3.6R



USB connectivity
Liberty 2.5i Premium
and 3.6R



harman kardon^{®1} speakers
Liberty 3.6R



Push-start ignition
Liberty 2.5i Premium
and 3.6R

1. harman kardon[®] is a registered trademark of HARMAN International Industries, Incorporated.



be inspired

Interior

On the inside choose from black or ivory cloth. Sumptuous leather¹ is available on selected variants and in a choice of ivory or black.



Leather
Black



Leather
Ivory



Cloth
Black



Cloth
Ivory

Exterior

The colour you choose for your Subaru makes a bold statement about who you are. So we've made sure you've got lots of ways to express yourself – with a wide range of colours to make your Subaru more... you.

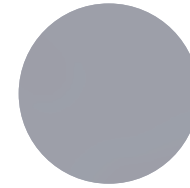

Ice Silver
Metallic

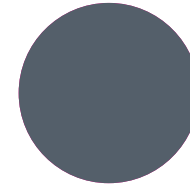

Platinum Grey
Metallic

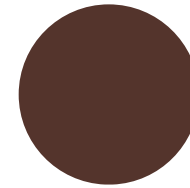

Oak Brown
Pearl

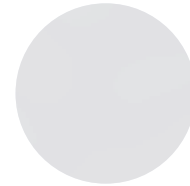

Crystal White
Pearl

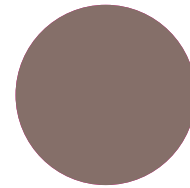

Tungsten
Metallic

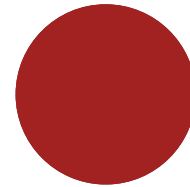

Crimson Red
Pearl

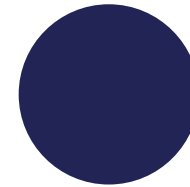

Dark Blue
Pearl

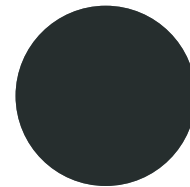

Dark Grey
Metallic

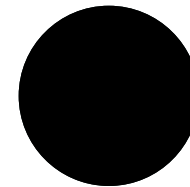

Crystal Black
Silica

1. Some parts of the seating or trim are not full natural leather.

Note: Paint colours are representative only and subject to variation due to the printing process.

why Liberty?

Symmetrical force of power

Our All-Wheel Drive philosophy

Greater balance and control. That's the confidence you get from our unique Symmetrical All-Wheel Drive System, which delivers the drive distribution to all four wheels, all the time. Every Subaru Liberty has an innate sense of balance from the ground up, thanks to a near perfect symmetrical layout.

Boxing clever

Our famous Subaru Boxer engine

While most engines stand vertically, ours lay flat. The famous Subaru Boxer engine delivers handling like no other engine can. Sitting horizontally in the engine bay, it moves like a boxer's fists with a punch and counterpunch action. Lightweight, low and flat, it makes for perfect balance and a much lower centre of gravity. It creates less noise and vibration too. All of this means better on-road handling for you. More stability. More performance. More fun. And a more confident drive.

DataDotDNA®

Every Subaru is fitted with advanced engine immobilisers and the DataDotDNA®¹ Theft Deterrent System. Microscopic dots are laser-etched with each vehicle's unique Vehicle Identification Number – making it a less attractive target for thieves.

Three Year Rebate on Theft Insurance Excess

DataDot Technology (Australia) Pty Ltd will pay your theft insurance excess² (up to a maximum of \$800 including GST) should your new Subaru be stolen and not recovered within 45 days despite the presence of DataDotDNA® and warning labels.

Finest safety

5 star ANCAP safety across the range

With spirit, quality and imagination comes some serious safety innovation. We want every Subaru to be amongst the safest cars on the road. Engineered full of cutting-edge technologies and the most intelligent design features. It's not a Subaru unless it carries the maximum 5 star ANCAP³ safety rating.

Eyes in the back of your head

Rear view reverse camera

Manoeuvring back into a tight side street? Family driveway littered with toys? Reverse with confidence, thanks to our rear view reverse camera technology. The rear view reverse camera is like having eyes in the back of your head. This greatly improves your visibility and reduces the risk of bumps and scrapes. A rear view reverse camera is standard on every Liberty variant.

Efficiency without compromise

Auto Stop Start

We're constantly thinking of ways to help the environment and become more fuel-efficient. That's why we developed Auto Stop Start technology. It saves fuel by immediately cutting the engine when you don't need it, like when you're idling or stopped in heavy traffic. The moment you're ready to move again, the engine restarts in a fraction of a second. Our Auto Stop Start technology is standard on Liberty 2.5i and 2.5i Premium variants.

1. DataDotDNA® is a theft deterrent not a theft prevention mechanism. 2. Vehicles must be registered, comprehensively insured and less than 3 years old. DTA must receive a claim within 45 days of the theft. Terms and conditions apply. 3. The Australasian New Car Assessment Program (ANCAP) gives consumers consistent information on the level of occupant protection provided by vehicles in serious front and side crashes.

Yet another world first

Lineartronic™ CVT

Pushing innovation beyond the bounds, we introduced an automatic transmission called Lineartronic™ CVT (Continuously Variable Transmission). And it's the reason our automatic models drive so smooth. It's the world's first longitudinally mounted system for AWD vehicles. Unlike a conventional automatic transmission – which uses fixed gear ratios – our Lineartronic™ CVT provides infinite variability between the highest and lowest available ratios. So you now experience a smoothness that also optimises the efficiency of the vehicle. For even more excitement, switch to manual mode for greater control to suit your driving style. Lineartronic™ CVT is standard on all Liberty variants.

Intelligently driven

Subaru Intelligent Drive

Heading to the shops? Taking on the Great Ocean Road? Each situation deserves a distinctive driving mode, so we crafted Subaru Intelligent Drive (SI-Drive) technology, available on all Liberty variants, to do just that. Switch from smart, to sporty to even sportier. Intelligent (I) mode – perfect for everyday driving, Sport (S) mode – for enhanced acceleration and all-round sporty performance and on the Liberty 3.6R, Sport Sharp (S#) mode – for a truly thrilling drive.

We're looking out for you

EyeSight® Driver Assist

We were the first car company to exclusively use stereo camera technology to detect objects in our vehicles path. A sign of our future-thinking and our commitment to quality, technology and safety, EyeSight® Driver Assist is like your second pair of eyes, spotting potentially dangerous situations. If EyeSight®

detects certain hazards that might be of danger, it warns you audibly, urging you to take action and brake. EyeSight® is standard on all Liberty variants and now includes a new Lane Keep Assist feature as part of its suite of technologies.

Clever thinking

Vision Assist

Imagine if your wing mirrors could alert you when there's something in your blind spot. Or if your high beams could automatically switch to low beam, when approaching oncoming traffic at night. We made all this happen - and more - with Subaru's Vision Assist.

Our suite of proactive safety technologies including Adaptive Driving Beam, Blind Spot Monitor, Front View Monitor, Lane Change Assist, Rear Cross Traffic Alert and Side View Monitor are always at work to help you feel safer on the road. Subaru's Vision Assist technologies are standard on the Subaru Liberty 2.5i Premium and 3.6R.

Liberty specifications¹

MODEL		2.5i	2.5i Premium	3.6R
Model Variant		Sedan	Sedan	Sedan
Transmission				
Lineartronic™ CVT with manual mode		•	•	•
Engine				
Engine type		Horizontally-opposed Boxer 4-cylinder, petrol engine		Horizontally-opposed Boxer 6-cylinder, petrol engine
Valve mechanism		DOHC 16-valve		DOHC 24-valve
Bore x stroke	mm	94.0 x 90.0		92.0 x 91.0
Capacity	cc	2498		3630
Compression ratio		10.3:1		10.5:1
Fuel tank capacity	litres	60		
Fuel system		Multi point sequential injection		
Fuel requirement (min)	RON	91		
Performance²				
Maximum power output (DIN)	kW/rpm	129kW@5800rpm		191kW@6000rpm
Maximum torque (DIN)	Nm/rpm	235Nm@4000rpm		350Nm@4400rpm
Acceleration 0 – 100 km/h	seconds	9.6		7.2
Electronic Throttle Control system (ETC)		Drive-by-wire		
Fuel consumption (ADR 81/02) For comparison purposes only. Real world results may vary ³ :				
	combined	l/100km	7.3	9.9
	urban	l/100km	9.1	14.2
	extra urban	l/100km	6.2	7.5
CO ₂ emissions (ADR81/02)	combined	(g/km)	166	230
Symmetrical All-Wheel Drive				
Type	Auto	Active Torque Split		

1. Subaru Australia reserves the right to change mechanical specification and equipment levels without notice. 2. All performance data measured using 95RON as required by Australian Design Rule 81/02. Vehicles tested in accordance with ADR 81/02. Acceleration test performed under controlled conditions. 3. Fuel consumption figures quoted are measured in accordance with Australian Design Rule 81/02 and are for comparison purposes only. Real world results may vary based on individual driving circumstances e.g. traffic conditions, driving style, vehicle conditions, fuel quality, climatic conditions etc. Quoted figures may not reflect real world fuel consumption.

Liberty specifications¹

MODEL		2.5i	2.5i Premium	3.6R
Gear ratio	1st	3.600		3.105
	2nd	2.080		1.983
	3rd	1.596		1.454
	4th	1.221		1.057
	5th	0.939		0.779
	6th	0.717		0.542
	7th	0.512		N/A
Gear ratio – reverse		3.687		3.021
Final reduction gear ratio		3.900		4.111
Steering				
Type		Electric power-assisted rack-and-pinion		
Minimum turning circle		m 11.2		
Suspension				
Type		Front	MacPherson struts, lower L-arms, coil springs, stabiliser bar	
		Rear	Double wishbone, coil springs, stabiliser bar	
Brakes				
Type		Front	Ventilated disc brake	
		Rear	Ventilated disc brake	
Brake booster type		Tandem		
ABS		4-channel, 4-sensor ABS with Electronic Brakeforce Distribution		
Wheels and Tyres				
Tyre manufacturer		Dunlop		
Tyres (width, profile, size, load index and speed rating)		225/50 R18 95W		
Rim size		18x7 1/2J		
Wheels		18"		
Spare wheel		18"		

1. Subaru Australia reserves the right to change mechanical specification and equipment levels without notice.

Liberty specifications¹

MODEL		2.5i	2.5i Premium	3.6R
Measurement				
Overall length	mm		4800	
Overall width	mm		1840	
Overall height	mm		1500	
Wheel base	mm		2750	
Front track	mm		1580	
Rear track	mm		1595	
Minimum ground clearance ²	mm		150	
Cargo volume – rear seat up/down	litres		493	
Seating capacity			5	
Kerb weight ³	kg	1552	1577	1659
Tare mass ³	kg	1512	1537	1619
Towing				
With trailer brakes (max)	kg	1500		1800
Without trailer brakes (max)	kg	750		750
Maximum tow ball down load	kg	150		180

1. Subaru Australia reserves the right to change mechanical specification and equipment levels without notice. 2. Ground clearance at kerb weight. 3. Vehicle kerb weight and tare mass varies according to the types of optional equipment included.

Liberty features¹

MODEL	2.5i	2.5i Premium	3.6R
Transmission			
Lineartronic™ CVT with manual mode	•	•	•
Safety Rating			
5 star ANCAP ² safety rating (maximum 5)	•	•	•
Collision Avoidance			
Symmetrical All-Wheel Drive (SAWD)	•	•	•
Vehicle Dynamics Control system (VDC) featuring:	•	•	•
Electronic Stability Control (ESC)	•	•	•
Anti-lock Braking System (ABS)	•	•	•
Electronic Brakeforce Distribution (EBD)	•	•	•
Brake Assist	•	•	•
Traction Control System (TCS)	•	•	•
Active Torque Vectoring system	•	•	•
Vision Assist featuring:		•	•
Adaptive Driving Beam (ADB)		•	•
Blind Spot Monitor (BSM)		•	•
Front View Monitor (FVM)		•	•
Lane Change Assist (LCA)		•	•
Rear Cross Traffic Alert (RCTA)		•	•
Side View Monitor (SVM)		•	•
4-wheel disc brakes	•	•	•
Electronic parking brake	•	•	•
Hill Hold Assist	•	•	•
Rear view reverse camera	•	•	•
Collision Protection			
SRS ³ airbags – dual front, dual front side and curtain	•	•	•
SRS ³ airbags – knee airbag (driver)	•	•	•
Front seat belts with pretensioners and load limiters	•	•	•
3 point A/ELR rear seat belts	•	•	•
Height-adjustable seat belt anchors – driver and front passenger	•	•	•
Seat belt warning lights – all seats	•	•	•

1. Subaru Australia reserves the right to change mechanical specification and equipment levels without notice. 2. The Australasian New Car Assessment Program (ANCAP) gives consumers consistent information on the level of occupant protection provided by vehicles in serious front and side crashes. 3. SRS: Supplemental Restraint System. Effective when used in conjunction with seat belts.

Liberty features¹

MODEL	2.5i	2.5i Premium	3.6R
Rear seat headrests for 3 seating positions	•	•	•
Height and angle-adjustable front seat headrests	•	•	•
Height-adjustable rear seat headrests	•	•	•
Ring-shaped passenger safety cell	•	•	•
Child Safety			
Child seat anchor points (x3)	•	•	•
ISOFIX child seat anchor points (x2)	•	•	•
Rear door child locks	•	•	•
Intelligent Driving Dynamics			
Auto Stop Start	•	•	
Subaru Intelligent Drive (SI-Drive)	2 modes	2 modes	3 modes
EyeSight® Driver Assist system featuring:	•	•	•
Adaptive Cruise Control	•	•	•
Brake Light Recognition	•	•	•
Lane Departure Warning	•	•	•
Lane Keep Assist	•	•	•
Lane Sway Warning	•	•	•
Lead Vehicle Start Alert	•	•	•
Pre-Collision Braking System	•	•	•
Pre-Collision Brake Assist	•	•	•
Pre-Collision Throttle Management	•	•	•
Pre-Collision Steering Assist	•	•	•
Electronic Throttle Control system (ETC)	•	•	•
Exterior			
Body coloured mirrors and door handles	•	•	•
Body coloured rear garnish	•	•	Chrome type
Bonnet with gas struts	•	•	•
Chrome type side skirt garnish			•
Chrome type inserts on door handles			•
Chrome type window sills	•	•	•
Detachable module type windscreen wipers	•	•	•

1. Subaru Australia reserves the right to change mechanical specification and equipment levels without notice.

Liberty features¹

MODEL	2.5i	2.5i Premium	3.6R
Door mirrors with indicators	Power folding	Heated and power folding	Heated and power folding
Dual tail pipes			•
Electric sunroof		•	•
Engine cover			•
Front wipers with de-icer	•	•	•
Full size spare wheel	•	•	•
Rear door and rear quarter privacy glass	•	•	•
Side sill skirts	•	•	•
Tail pipe covers	•	•	•
18" alloy wheels	•	•	•
Lighting – Exterior			
LED daytime running lights	•	•	•
LED front fog lights	•	•	•
Headlights – halogen with auto off	•		
Headlights – dusk-sensing	•	•	•
Headlights – self-levelling LED with auto off		•	•
Rear LED combination lights	•	•	•
Rear LED stoplight	•	•	•
Steering Responsive Headlights (SRH)		•	•
Welcome lighting	•	•	•
Lighting – Interior			
Blue interior door grip illumination	•	•	•
Cabin and cargo area lights	•	•	•
Illuminated ignition ring	•		
Map lights (x2)	•	•	•
Front puddle lamps	•	•	•
Air-conditioning			
Air-conditioning – dual zone climate control with rear vents	•	•	•
Anti-dust filter	•	•	•
Front and side demisters	•	•	•
Floor heater ducts for rear passengers	•	•	•
Rear windscreen demister – electric	•	•	•

1. Subaru Australia reserves the right to change mechanical specification and equipment levels without notice.

Liberty features¹

MODEL	2.5i	2.5i Premium	3.6R
Security			
DataDotDNA ^{®2} security system	•	•	•
Immobiliser security system	•	•	•
Instrumentation and Controls			
Adjustable steering wheel – height and telescopic	•	•	•
Electroluminescent gauges with colour MID	•	•	•
Customisable gauge colours	•	•	•
Instrument cluster	•	•	•
Manual mode	•	•	•
One touch lane change indicator	•	•	•
Paddle gear shifters	•	•	•
Sports pedals	•	•	•
Twin trip meter (switchable)	•	•	•
Steering wheel controls:	•	•	•
Audio	•	•	•
EyeSight [®]	•	•	•
Bluetooth ^{®3}	•	•	•
MID	•	•	•
SI-Drive	•	•	•
Multi-Function Displays			
Multi-Information Display unit (MID) featuring:	•	•	•
Audio display	•	•	•
Auto Stop Start information	•	•	•
Bluetooth ^{®3} phone display	•	•	•
5" LCD screen	•	•	•
Digital speedometer	•	•	•
Eco-gauge display	•	•	•
EyeSight [®] display	•	•	•
Fuel economy and journey information	•	•	•
Outside temperature and clock display	•	•	•
SI-Drive display	•	•	•
Warning display	•	•	•

1. Subaru Australia reserves the right to change mechanical specification and equipment levels without notice. 2. DataDotDNA[®] is a theft deterrent not a theft prevention mechanism. 3. Bluetooth[®] is a registered trademark of Bluetooth SIG Inc. System operation ability is subject to the Bluetooth[®] wireless technology specification of individual device.

Liberty features¹

MODEL	2.5i	2.5i Premium	3.6R
Storage			
Cargo hooks	•	•	•
Centre console box	•	•	•
Cupholders – rear and centre console	•	•	•
Door pockets with integrated bottle holder – front and rear	•	•	•
In-dash console box	•	•	•
Overhead console – sunglass holder	•	•	•
Seat back pocket – driver and front passenger side	•	•	•
Convenience			
12V/120W power jacks (x2)	•	•	•
Auto-dimming rear view mirror		•	•
Auto door lock/unlock	•	•	•
Boot unlock on remote central locking keys	•	•	•
Illuminated sunvisors with vanity mirrors - driver and front passenger	•	•	•
Interior fuel lid lock release	•	•	•
Intermittent variable speed front windscreen wipers	•	•	•
Rain-sensing front windscreen wipers	•	•	•
Power steering, mirrors and windows	•	•	•
Rear seat centre armrest	•	Black with chrome type	Black with chrome type
Remote central locking (keys x2)	•	•	•
Smart key and push-start ignition		•	•
USB charge port - rear passengers (x2)	•	•	•
Interior Trims			
Carpet trim – black	•	•	•
Gear shift surround – gloss black	•	•	•
Leather ² steering wheel and gear shift	•	•	•
Seat trim – black or ivory cloth	•		
Seat trim – black or ivory leather ²		•	•
Side sill plates (front) – stainless	•	•	•
Seating Extras			
60/40 split folding rear seats	•	•	•
8-way power seat with dual memory – driver		•	•
8-way power seat – front passenger		•	•

1. Subaru Australia reserves the right to change mechanical specification and equipment levels without notice. 2. Some parts of the seating or trim are not full natural leather.

Liberty features¹

MODEL	2.5i	2.5i Premium	3.6R
Electric lumbar support – driver		•	•
Heated seats – driver and front passenger		•	•
Manual seat height lifter – driver	•		
Entertainment			
Integrated infotainment system featuring:	•	•	•
Satellite navigation		•	•
AM/FM radio	•	•	•
Single CD player	•	•	•
Apple CarPlay™ and Android Auto™ connectivity ²	•	•	•
6.5" LCD touchscreen	•		
8" LCD touchscreen		•	•
Siri® compatibility		•	•
6 speakers	•	•	
11 harman kardon® ³ speakers, subwoofer and amplifier			•
Bluetooth® ⁴ wireless technology with:	•	•	•
Handsfree mobile communication	•	•	•
Audio streaming ⁵	•	•	•
Voice command recognition	•	•	•
Auxiliary jack – front centre console	•	•	•
USB connection – front centre console	(x1)	(x2)	(x2)
Owner Benefits			
5 Year/Unlimited Km Warranty	•	•	•
5 Year/125,000 Km Capped Price Servicing Program ⁶	•	•	•
12 Month Roadside Assistance Program ⁷	•	•	•

1. Subaru Australia reserves the right to change mechanical specification and equipment levels without notice. 2. Compatible Apple or Android device required. 3. harman kardon® is a registered trademark of HARMAN International Industries, Incorporated. 4. Bluetooth® is a registered trademark of Bluetooth SIG Inc. System operation ability is subject to Bluetooth® wireless technology specification of individual device. 5. There may be restrictions on features available for certain variants that are not fully compliant with the AVCRP. 6. Every eligible Model Year 2018 onward Subaru Liberty comes with Subaru's 5 Year/125,000 Km Capped Price Servicing Program. Available at participating Subaru retailers only and does not apply to rental and some other classes of vehicles. For full Capped Price Servicing Terms and Conditions visit www.subaru.com.au/service/pricing/capped-price-servicing. 7. 12 Month Roadside Assistance Program is standard upon activation with relevant Motoring Club in each state. To receive this benefit the customer must opt into the 12 Month Roadside Assistance program at time of vehicle delivery. Eligible customers are those retail and novated lease customers who purchase a new Subaru on or after 1st June 2013 and have less than 5 vehicles under the Club Membership offer. Customers must provide a valid phone and residential address, as well as date of birth. Fleet, Government and Rental companies are excluded.



Liberty 3.6R

accessories for everything you do

For those who enjoy packing more into every trip, Subaru Liberty has accessories for all the things you love to do. Take all your gear with you and do more with confidence thanks to Liberty's customised accessories.

- + Styling Bring out your distinctive Liberty style with a range of stylish exterior options.
- + Protection Protect your Liberty with a range of products including carpet mat sets, a cargo tray and a rear bumper protector.
- + Cargo To extend your Liberty's carrying capacity we offer a broad range of Subaru and Thule sport and cargo carrier accessories.
- + Security, Convenience and Safety Keep your new wheels secure with a set of wheel lock nuts and make tight parks easy with front corner and reverse parking sensors. New parents will also love a 6-point-harness baby seat that integrates with Subaru Liberty's ISOFIX anchor points.
- + STI Performance Parts Tweak the performance of Subaru Liberty for that extra edge. Bring out the beast with performance parts for optimum handling and control.

Genuine Subaru Accessories are available from your Subaru Retailer, so be sure to ask about the range when buying your new Subaru Liberty.

 To view our complete range of accessories and pricing online visit www.subaru.com.au/liberty/accessories



do™



packs that will inspire you

From action-packed to packing the back, these quality Genuine Subaru Accessory Packs will give you the protection you need and versatility you desire to do more with your Subaru Liberty.

Both stylish and functional, each of our pack accessories have been custom made for a tailored fit to complement your Subaru Liberty and keep it looking good for years to come.

Plus all Genuine Subaru Accessories are protected by our manufacturer's warranty¹.

Protection Pack includes:

a Mud Guards (Front and Rear)

Help protect the sides of your Liberty from nasty stone chips with tailor-made mud guards.

b Carpet Mat Set

Enjoy the comfort with a luxurious Subaru branded quality carpet mat set.

c Cargo Tray

Throw all the gear in the back with a heavy duty mat to protect the cargo area from dust and dirt.

d Weather Shields

Sleekly designed with integrated chrome style mouldings that are tailored to fit onto each door individually.

Explorer Pack includes:

Add a Tow Bar to the Protection Pack to squeeze more out of your everyday.

e Tow Bar

Hook your toys up to a functional and sturdy tow bar engineered specifically for the Australian market.



a

b

c

d

do

1. For full warranty terms and conditions, visit www.subaru.com.au/accessories-information/warranty

protect your investment

Get out and do more while protecting your Liberty from the rough and tumble of daily life. From carpet mats to mud guards, each of the below accessories are tailored for a perfect fit.

ACCESSORY	Part Number	2.5i	2.5i Premium	3.6R
Styling				
1 Front Grille	J1010AL310		•	•
2 Front Grille (with camera cover)	J1010AL310K	•		
3 Alloy Wheel Set 18" – Red	B3110VA500K	•	•	•
4 Alloy Wheel Set 18" – Blue	B3110VA600K	•	•	•
Protection				
5 Headlamp Protectors	J101AAL010		•	•
6 Weather Shields	F0010AL700	•	•	•
7 Mud Guards (Front) ¹	J1010AL001NN	•	•	
8 Mud Guards (Rear)	J1010AL024NN	•	•	•
9 Rear Seat Pet Protector	F4110SG000	•	•	•
10 Carpet Mat Set	J5010AL000	•	•	•
11 Rubber Mat Set	J5010AL100	•	•	•
12 Body Side Moulding	J1010AL600##	•	•	•
13 Body Side Moulding (Non-painted)	J1010AL600NN	•	•	•
14 Liberty Protection Film	SAT2017	•	•	•
15 Bootlip and Bumper Protector	SAT6003	•	•	•

1. Mud Guards (Front) also available for Liberty 3.6R – Part Number J1010AL101NN.
Denotes colour option of your choice.

 To view our complete range of accessories and pricing online visit www.subaru.com.au/liberty/accessories

•

Not Applicable

Applicable

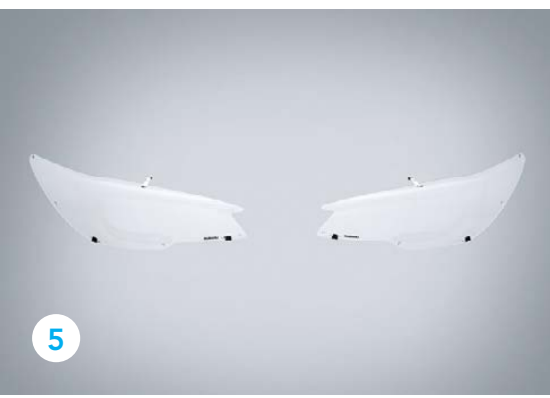

16



17



18



19



20



21

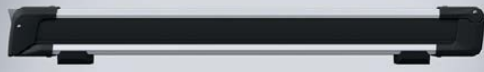

22



23



24



25

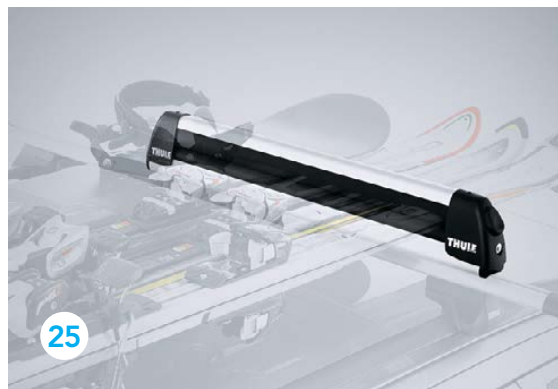

26



27

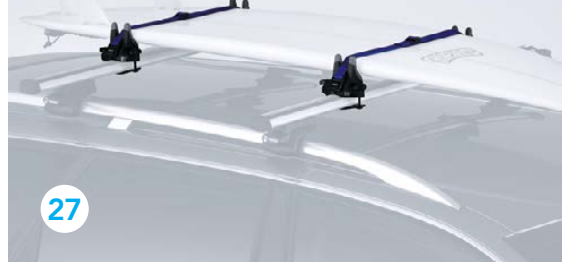

28



29



do all the things you've planned

Tow it, stow it or just pack more into your every day with our range of Liberty compatible cargo options, plus premium Thule sport and cargo carrier accessories.

ACCESSORY	Part Number	2.5i	2.5i Premium	3.6R
Cargo and Tow				
16 Tow Bar	L101AAL012	•	•	•
17 Cargo Tray	J501AAL100	•	•	•
18 Roof Cross Bars	SAT3011	•	•	•
Thule Roof Attachments and Accessories				
19 Xtender 6 Pair Ski Holder	SA1156	•	•	•
20 Deluxe Ski Carrier – 4 Pair	SAT8023	•	•	•
21 Deluxe Ski Carrier – 6 Pair	SAT8024	•	•	•
22 Bicycle Holder – Silver (Upright)	SAT8018	•	•	•
23 Bicycle Holder – Black (Upright)	SAT8019	•	•	•
24 Bicycle Holder (Fork Mounted)	SA1042	•	•	•
25 Ski Holder – 4 Pair	SAT9012	•	•	•
26 Ski Holder – 6 Pair	SAT9013	•	•	•
27 Surfboard Carrier	SA1139	•	•	•
28 Kayak Carrier – Dockglide	SAT9018	•	•	•
29 Thule Paddleboard & Mal Carrier	SAT8016	•	•	•

 To view our complete range of accessories and pricing online visit www.subaru.com.au/liberty/accessories

ACCESSORY		Part Number	2.5i	2.5i Premium	3.6R
Thule Roof Attachments and Accessories					
30	Luggage Pod Touring 100 (Titan Aeroskin) Textured Finish (Small)	SAT5008	•	•	•
31	Luggage Pod Touring 100 (Black Glossy) Smooth Finish (Small)	SAT5008B	•	•	•
32	Luggage Pod Motion XT M (Glossy Silver)	SAT9014	•	•	•
33	Luggage Pod Motion XT M (Glossy Black)	SAT9015	•	•	•
34	Luggage Pod Motion XT XL (Glossy Silver)	SAT9016	•	•	•
35	Luggage Pod Motion XT XL (Glossy Black)	SAT9017	•	•	•
36	Thule Go Box	SAT8005	•	•	•
37	Thule Go Pack Set (4 Bags)	SAT8006	•	•	•
38	Side Up Wheel Step	SAT9004	•	•	•
Tow Bar Attachments (Tow Bar required)					
39	Thule Tow Bar Mounted Bike Carrier (Two Bikes)	SAP925	•	•	•
40	Thule Tow Bar Mounted Bike Carrier (Three Bikes)	SAP927	•	•	•
Security					
41	Wheel Lock Nuts	B327EYA000	•	•	•
Convenience and Safety					
42	Reverse Sensors	H481AAL400##	•	•	•
43	Front Corner Parking Sensors	H481AAL300##	•	•	•
44	Cigarette Lighter	H6710AL010	•	•	•
45	Round Type Ash Tray (Black)	92172AG040	•	•	•

Denotes colour option of your choice.

 To view our complete range of accessories and pricing online visit www.subaru.com.au/liberty/accessories



30



31



32



33



34



35



36



37



38



39



40



41



42



43



44



45

46



47



48



49



50



51



52



53



54



55



56



57



58



59



kick it into overdrive

Show your allegiance with bold, branded accessories to protect and style your new Subaru Liberty.

ACCESSORY	Part Number	2.5i	2.5i Premium	3.6R
Convenience and Safety				
46 First Aid Kit	PR7670	•	•	•
47 Safety Triangle	SAT9007	•	•	•
48 Baby Seat – Kompressor Beyond Midnight	SAC7004	•	•	•
49 Garmin Dash Cam 55	0100175011	•	•	•
50 Magnetic Mount (additional)	0101253000	•	•	•
STI Performance Parts				
51 Front Under Spoiler	ST96020BB050A	•	•	•
52 STI Shift Knob CVT	C1010AL000	•	•	•
53 STI Flexible Tower Bar	E4010AL000	•	•	•
54 STI ENKEI Alloy Wheel Set (4) – 18x7.5 (Silver)	B3110AL031K	•	•	•
55 STI ENKEI Alloy Wheel Set (4) – 18x7.5 (Gun Metal)	B3110AL041K	•	•	•
56 STI ENKEI Alloy Wheel Set (4) – 18x7.5 (Black)	B3110AL051K	•	•	•
57 Wheel Lock Nut Set (Black)	ST28170ST020	•	•	•
58 Security Wheel Nut Set	ST28170ST060	•	•	•
59 Valve Cap Set	ST28102ST030	•	•	•

 To view our complete range of accessories and pricing online visit www.subaru.com.au/liberty/accessories

welcome to the family

There are cars that simply get you from A to B, and then there are cars that empower you. Buying a Subaru is like embracing life with both hands and knowing that nothing is going to stop you. When you buy a new Subaru you

my SUBARU are welcomed into an owner's program that gives you access to a number of benefits.

Subaru New Car Warranty – 5 Year/Unlimited Kilometres

Every new Subaru purchased on or after 1st January 2019 is covered by a 5 Year/Unlimited Kilometre manufacturer's national warranty. Visit subaru.com.au/warranty or ask your Subaru Retailer for more information.

Subaru Capped Price Servicing

With our 5 Year/125,000 Kilometre Capped Price Servicing Program¹, you'll now know the maximum amount you will have to pay for your next scheduled service during the Program period. You'll also have peace of mind knowing that specialist Subaru



technicians will be looking after your pride and joy using only Genuine Subaru Parts.

DataDotDNA[®]

Every Subaru is fitted with advanced engine immobilisers and the DataDotDNA^{®2} Theft Deterrent System. Microscopic dots are laser-etched with each vehicle's unique Vehicle Identification Number – making it a less attractive target for thieves.

Three Year Rebate on Theft Insurance Excess

DataDot Technology (Australia) Pty Ltd will pay your theft insurance excess³ (up to a maximum of \$800 including GST) should your new Subaru be stolen and not recovered within 45 days despite the presence of DataDotDNA[®] and warning labels.

1-Month Health Check and Chat

The 1-Month Health Check and Chat is a free consultation within the first month after delivery

of your new Subaru. It allows our Subaru-trained technicians to provide quick vehicle checks, and one of our Service Advisors will answer any of your questions to help ensure an ongoing, worry-free experience.

Subaru's Map Updates

If your new Subaru is fitted with a factory line fit navigation unit, your unit will be covered by Subaru's Map Update Program⁴ – guaranteeing you'll have access to the latest maps for the first 3 years of ownership.

My Subaru – online owner's destination

The My Subaru owner's portal is an online destination for owners which provides access to exclusive benefits, tailored content, your vehicle's ownership history and much more. Login to My Subaru, the online destination for Subaru owners that will help you get more out of your vehicle, and more out of your life.

Visit my.subaru.com.au

1. Every eligible Model Year 2018 onward Subaru Liberty comes with Subaru's 5 Year/125,000 Km Capped Price Servicing Program. Available at participating Subaru retailers only and does not apply to rental and some other classes of vehicles. For full Capped Price Servicing Terms and Conditions visit www.subaru.com.au/service/pricing/capped-price-servicing. 2. DataDotDNA[®] is a theft deterrent not a theft prevention mechanism. 3. Vehicles must be registered, comprehensively insured and less than 3 years old. DTA must receive a claim within 45 days of the theft. Terms and conditions apply. 4. Subaru's Map Update Program is available on 2018 Subaru Liberty models purchased from 21st February 2018 onwards with the factory line fit Gen3 navigation unit. Subaru's Map Update Program is not available on accessory fit or dealer sourced navigation units. Subaru Australia reserves the right to add and remove eligible vehicles at its discretion. For full terms and conditions of the Subaru Map Update Program visit www.subaru.com.au/owner-experience/benefits/subaru-map-update-program. 3 Year Map Update Guarantee subject to the vehicle having its scheduled services performed at an authorised Subaru Service Centre during the program period.

live life without limits

Subaru Roadside Assistance

Enjoy 12 months of Australia-wide, standard Roadside Assistance when you purchase your new Subaru. In the unfortunate situation where you need that extra helping hand, our Roadside Assistance will help¹ with arranging a tow, battery service, flat tyre service, fuel delivery and lockout service.

Subaru Certified Collision Repairer Network

With a dedicated Certified Collision Repairer² helpline available on 1800 737 179, help is never far away. Available 24-hours a day, 7 days a week, help will always be available when you need it most. Subaru Certified Collision Repairers guarantee that trained specialists will repair your Subaru to strict factory specifications using Subaru Genuine Parts.

Genuine Accessories

Genuine Subaru Accessories are designed to enhance your vehicle, are factory approved by Subaru and are protected by the Genuine Subaru Accessories Warranty. For our full range of Subaru Liberty accessories visit [subaru.com.au/liberty/accessories](https://www.subaru.com.au/liberty/accessories). For warranty information visit [subaru.com.au/warranty](https://www.subaru.com.au/warranty) and click on "Genuine Subaru Accessories Warranty".

Subaru Finance

Subaru Finance³ provides a range of competitive financial solutions to approved customers. Our finance specialists will help you find a finance package to meet your needs conveniently.

Subaru Insurance

It's important to enjoy the freedom of owning a Subaru, but it's also important to protect it. A range of Subaru Insurance⁴ options provides a variety of choices, including: Subaru Comprehensive Motor Vehicle Insurance, Subaru Motor Equity Insurance and Subaru Loan Protection Insurance.

1. 12 month Club Membership and Roadside Assistance Offer is standard upon activation with the relevant Motoring Club in each state. To receive this benefit the customer must opt into the 12 month Club Membership and Roadside Assistance Offer at time of vehicle delivery. Eligible customers are those retail and novated lease customers who purchase a new Subaru and have less than 5 vehicles under the Club Membership offer. Customers must provide a valid phone number and residential address, as well as date of birth. Fleet, Government and Rental companies are excluded. Terms and conditions apply. For a full list of benefits, visit www.subaru.com.au/owner-experience/benefits/program/roadside. 2. Subaru Certified Collision Repairer network not available in all areas. Call 1800 737 179 or visit www.subaru.com.au/retailers to find your closest Subaru Certified Collision Repairer. 3. Finance provided by Macquarie Leasing Pty Limited ABN 38 002 674 982 Australian Credit Licence Number 394925 trading as Subaru Finance. All applications for credit are subject to Macquarie's normal credit approval criteria. Terms and conditions, fees and charges apply. 4. Subaru Insurance products are issued by Allianz Australia Insurance Limited AFS Licence No. 234 708 ABN 15 000 122 850 (Allianz). In arranging this insurance Subaru (Aust) Pty Limited ABN 95 000 312 792 (Subaru) and the authorised dealers act as agents of Allianz and not as your agent. Neither Subaru nor any of its related companies or appointed authorised retailers have any liability in respect of these policies.

Liberty Awards

- 2015 - Australasian New Car Assessment Program 5 star ANCAP safety rating
- 2009 - Australia's Best Cars, Prestige Car, Liberty 3.6R Premium
 - Australasian New Car Assessment Program 5 star ANCAP safety rating
- 2008 - International Engine of the Year Award, 2.0 - 2.5-litre class,
(2.5-litre turbocharged horizontally-opposed Boxer engine)
- 2006 - International Engine of the Year Award, 2.0 - 2.5-litre class,
(2.5-litre turbocharged horizontally-opposed Boxer engine)
- 2005 - Australia's Best Cars, Best Luxury Car under \$57,000, Subaru Liberty 3.0R
- 2004 - Australia's Best Cars, Best Mid-Size Car over \$28,000, Subaru Liberty 2.5i
- 2001 - Australia's Best Cars, Best Mid-Size Car over \$25,000, Subaru Liberty RX
- 2000 - Australia's Best Cars, Best Mid-Size Car over \$25,000, Subaru Liberty RX
 - Which Car, Gold Medal, Medium Car Category, Subaru Liberty
 - Autocar, New Zealand, Car of the Year, Subaru Liberty
 - Autocar, New Zealand, Best Medium Car, Subaru Liberty
 - J.D. Power and Associates/Top Gear U.K. Customer Satisfaction Study,
Gold Award – Subaru Liberty
- 1999 - NRMA/RACV, Best Mid-Size Car – Subaru Liberty RX
- 1998 - Wheels Magazine, Wheels Car of the Year – Subaru Liberty Wagon
- 1994 - Wheels Magazine, Car of the Year – Subaru Liberty

Subaru Australia reserves the right to vary vehicle specifications and standard features in Australia from those detailed in this brochure. Vehicles shown in this brochure may be fitted with accessories available at additional cost. No part of the brochure can be reproduced without written permission from Subaru Australia. Printed in Australia.

subaru.com.au

© Copyright 2018 – Subaru (Aust) Pty Limited. All rights reserved.
Subaru (Aust) Pty Limited ABN 95 000 312 792 (Subaru Australia) PO Box 8311, Norwest NSW 2153 Toll Free: 1800 226 643



SUBARU