

SUBARU
LEVORG
SPORTSWAGON
2019

every moment
is a chance to **do**



SUBARU



Find out more at subaru.com.au/levorg



turbocharge every moment

The 2019 Subaru Levorg Sportswagon has arrived, to make every day faster, better and more fun. With a ground-breaking combination of space, style and performance, this is no ordinary wagon.

With a direct injection, turbocharged horizontally-opposed four cylinder Boxer engine combined with Symmetrical All-Wheel Drive (AWD) and loads of high tech features, the Levorg Sportswagon gives you big value.

Plus – every Levorg Sportswagon has achieved the maximum 5 star ANCAP¹ safety rating, with clever collision protection and advanced proactive safety technologies.

Make the most of every moment, every day, in the new Subaru Levorg Sportswagon.

1. The Australasian New Car Assessment Program (ANCAP) gives consumers consistent information on the level of occupant protection provided by vehicles in serious front and side crashes.



Levorg 1.6 GT AWD

one fun family wagon

The Subaru Levorg 1.6 GT AWD packs incredible value into a stunning Sportswagon. Great driving dynamics, a 1.6-litre turbocharged Boxer engine and 6.5" LCD touchscreen infotainment unit – it's always a joyride.

Features include dual zone air-conditioning, 17" alloy wheels, rear view reverse camera, dusk-sensing headlights, rain-sensing front wipers, heated and power-folding door mirrors, smart key and push-start ignition. Subaru's award-winning EyeSight® Driver Assist technology also comes standard, giving you a second pair of eyes on the road ahead.

Levorg 1.6 GT AWD features

Performance

- + Symmetrical All-Wheel Drive (AWD)
- + 1.6-litre Direct Injection turbocharged horizontally-opposed Boxer engine
- + Lineartronic® CVT transmission
- + Maximum power output: 125kW@4800-5600rpm
- + Maximum torque: 250Nm@1800-4800rpm
- + SI-Drive – 2 modes

Interior

- + 40/20/40 split folding rear seats
- + Air-conditioning – dual zone climate control
- + Cloth seat trim – black
- + Leather steering wheel and gear shift
- + Manual seat height lifter – driver
- + One touch lane change indicator
- + One touch electric folding rear seats
- + Paddle gear shifters
- + Reclining rear seat
- + Retractable cargo blind

- + Silver stitching
- + Smart key and push-start ignition
- + Sports pedals

Exterior

- + 17" alloy wheels
- + Bonnet scoop
- + Door mirrors with indicators – heated and power-folding
- + Dual tail pipes
- + Front fog lights – LED
- + Rear spoiler
- + Self-levelling LED headlights with auto off (dusk-sensing)
- + Shark fin antenna

Entertainment/Technology

- + Bluetooth®¹ wireless technology
- + EyeSight® Driver Assist system featuring:
 - + Adaptive Cruise Control

- + Brake Light Recognition
- + Lane Departure Warning
- + Lane Keep Assist
- + Lane Sway Warning
- + Lead Vehicle Start Alert
- + Pre-Collision Brake Assist
- + Pre-Collision Braking System
- + Pre-Collision Steering Assist
- + Pre-Collision Throttle Management
- + Integrated infotainment system featuring:
 - + 6.5" LCD touchscreen
 - + Apple CarPlay® and Android Auto™ connectivity²
 - + Digital radio³ (DAB+)
- + Multi-Function Display unit (MFD) with 5.9" LCD touchscreen
- + Multi-Information Display unit (MID)
- + Rear view reverse camera
- + USB connection
- + USB charge ports (x4)

1. Bluetooth® is a registered trademark of Bluetooth SIG Inc. System functionality is subject to the Bluetooth® wireless technology specification of individual device. 2. Compatible Apple® or Android™ device required. 3. Digital radio station coverage dependent on vehicle location.

everyday even more epic

The Subaru Levorg 1.6 GT Premium AWD makes every day even more epic with an electric sunroof, smart rear view mirror, a larger 7" LCD touchscreen infotainment unit and satellite navigation. Turbocharge your comfort with heated leather¹ sports bucket seats in the front and an 8-way power adjusted driver's seat, with electric lumbar support.

Bilstein® suspension delivers incredible handling, while Subaru's Vision Assist adds Blind Spot Monitors, Lane Change Assist, Rear Cross Traffic Alert and more.

Levorg 1.6 GT Premium AWD features

Performance

- + Symmetrical All-Wheel Drive (AWD)
- + 1.6-litre Direct Injection turbocharged horizontally-opposed Boxer engine
- + Lineartronic® CVT transmission
- + Maximum power output: 125kW@4800-5600rpm
- + Maximum torque: 250Nm@1800-4800rpm
- + Bilstein® sports suspension
- + SI-Drive – 2 modes

Interior

- + 40/20/40 split folding rear seats
- + 8-way power seat with dual memory – driver
- + Air-conditioning – dual zone climate control
- + Auto-dimming smart rear view mirror
- + Electric lumbar support – driver
- + Heated front seats
- + Leather¹ seat trim – black
- + Leather steering wheel and gear shift
- + One touch electric folding rear seats
- + Paddle gear shifters
- + Smart key and push-start ignition

- + Sports bucket seats – driver and front passenger
- + Sports pedals

Exterior

- + 18" alloy wheels
- + Door mirrors with indicators – heated and power-folding
- + Electric sunroof
- + Front fog lights – LED
- + Rain-sensing front wipers with de-icer
- + Self-levelling LED headlights with auto off (dusk-sensing)

Entertainment/Technology

- + Bluetooth®² wireless technology
- + Integrated infotainment system featuring:
 - + 7" LCD touchscreen
 - + Apple CarPlay® and Android Auto™ connectivity³
 - + Digital radio⁴ (DAB+)
 - + Satellite navigation

- + EyeSight® Driver Assist system featuring:
 - + Adaptive Cruise Control
 - + Brake Light Recognition
 - + Lane Departure Warning
 - + Lane Keep Assist
 - + Lane Sway Warning
 - + Lead Vehicle Start Alert
 - + Pre-Collision Brake Assist
 - + Pre-Collision Braking System
 - + Pre-Collision Steering Assist
 - + Pre-Collision Throttle Management
- + Multi-Function Display unit (MFD) with 5.9" LCD touchscreen
- + Rear view reverse camera
- + USB connections (x2)
- + Vision Assist featuring:
 - + Blind Spot Monitor (BSM)
 - + EyeSight® Assist Monitor
 - + Front View Monitor (FVM)
 - + High Beam Assist (HBA)
 - + Lane Change Assist (LCA)
 - + Rear Cross Traffic Alert (RCTA)
 - + Side View Monitor (SVM)

Everyday even more epic.
Explore the range at subaru.com.au/levorg

1. Some parts of the seating or trim are not full natural leather. 2. Bluetooth® is a registered trademark of Bluetooth SIG Inc. System functionality is subject to the Bluetooth® wireless technology specification of individual device. 3. Compatible Apple® or Android™ device required. 4. Digital radio station coverage dependent on vehicle location.





Levorg 1.6 GT Premium AWD



Levorg 2.0 GT-S AWD

do more power

The Subaru Levorg 2.0 GT-S AWD boasts 197kW of turbocharged power and Active Torque Vectoring technology, which uses the braking system to deliver vice-like grip through corners.

Choose from three distinctive driving modes to turbocharge every journey: Intelligent (I) mode for everyday driving, Sport (S) mode for enhanced acceleration and Sport Sharp (S#) mode for a truly exhilarating drive.

Levorg 2.0 GT-S AWD features

Performance

- + Symmetrical All-Wheel Drive (AWD)
- + 2.0-litre Direct Injection turbocharged horizontally-opposed Boxer engine
- + Bilstein® sports suspension
- + Lineartronic® CVT transmission
- + Maximum power output: 197kW@5600rpm
- + Maximum torque: 350Nm@2400-5200rpm
- + SI-Drive – 3 modes

Interior

- + 40/20/40 split folding rear seats
- + 8-way power seat with dual memory – driver
- + Air-conditioning – dual zone climate control
- + Auto-dimming smart rear view mirror
- + Electric lumbar support – driver
- + Heated front seats
- + Leather¹ seat trim – choice of black or bright pearl
- + Leather steering wheel and gear shift
- + One touch electric folding rear seats
- + Paddle gear shifters
- + Smart key and push-start ignition

- + Sports bucket seats – driver and front passenger
- + Sports pedals

Exterior

- + 18" alloy wheels
- + Door mirrors with indicators – heated and power-folding
- + Electric sunroof
- + Front fog lights – LED
- + Rain-sensing front wipers with de-icer
- + Self-levelling LED headlights with auto off (dusk-sensing)

Entertainment/Technology

- + Bluetooth®² wireless technology
- + EyeSight® Driver Assist system featuring:
 - + Adaptive Cruise Control
 - + Brake Light Recognition
 - + Lane Departure Warning
 - + Lane Keep Assist
 - + Lane Sway Warning
 - + Lead Vehicle Start Alert

- + Pre-Collision Brake Assist
- + Pre-Collision Braking System
- + Pre-Collision Steering Assist
- + Pre-Collision Throttle Management
- + Integrated infotainment system featuring:
 - + 7" LCD touchscreen
 - + Apple CarPlay® and Android Auto™ connectivity³
 - + Digital radio⁴ (DAB+)
 - + Satellite navigation
- + Multi-Function Display unit (MFD) with 5.9" LCD touchscreen
- + Rear view reverse camera
- + USB connections (x2)
- + Vision Assist featuring:
 - + Blind Spot Monitor (BSM)
 - + EyeSight® Assist Monitor
 - + Front View Monitor (FVM)
 - + High Beam Assist (HBA)
 - + Lane Change Assist (LCA)
 - + Rear Cross Traffic Alert (RCTA)
 - + Side View Monitor (SVM)

Do more power.

Explore the range at subaru.com.au/levorg

1. Some parts of the seating or trim are not full natural leather. 2. Bluetooth® is a registered trademark of Bluetooth SIG Inc. System functionality is subject to the Bluetooth® wireless technology specification of individual device. 3. Compatible Apple® or Android™ device required. 4. Digital radio station coverage dependent on vehicle location.

do the ultimate getaway car

The Subaru Levorg 2.0 STI Sport AWD means full on fun, combining 197kW of turbocharged power with specially tuned Bilstein® suspension. It adds a range of exclusive features from Subaru Tecnica International (STI), Subaru's specialist motorsport division that develops performance-tuned handling and adrenaline-charged styling.

Amp up the attitude with larger exhaust pipe tips, red interior stitching, and an exclusive sports kit with 18" alloy wheels, front bumper and front grille.

Levorg 2.0 STI Sport AWD features

Performance

- + Symmetrical All-Wheel Drive (AWD)
- + 2.0-litre Direct Injection turbocharged horizontally-opposed Boxer engine
- + Bilstein® sports suspension with STI coil springs
- + Lineartronic® CVT transmission
- + Maximum power output: 197kW@5600rpm
- + Maximum torque: 350Nm@2400-5200rpm
- + SI-Drive – 3 modes

Interior

- + 40/20/40 split folding rear seats
- + 8-way power seat with dual memory – driver
- + Air-conditioning – dual zone climate control
- + Auto-dimming smart rear view mirror
- + Electric lumbar support – driver
- + Heated front seats
- + Leather¹ seat trim – maroon and black
- + Leather steering wheel and gear shift
- + One touch electric folding rear seats
- + Paddle gear shifters
- + Smart key and push-start ignition

- + Sports bucket seats – driver and front passenger
- + Sports pedals

Exterior

- + 18" alloy wheels – exclusive design
- + Door mirrors with indicators – heated and power-folding
- + Electric sunroof
- + Exclusive front bumper
- + Front fog lights – LED
- + Rain-sensing front wipers with de-icer
- + Self-levelling LED headlights with auto off (dusk-sensing)
- + STI badge – front and rear

Entertainment/Technology

- + Bluetooth² wireless technology
- + EyeSight® Driver Assist system featuring:
 - + Adaptive Cruise Control
 - + Brake Light Recognition
 - + Lane Departure Warning
 - + Lane Keep Assist

- + Lane Sway Warning
- + Lead Vehicle Start Alert
- + Pre-Collision Brake Assist
- + Pre-Collision Braking System
- + Pre-Collision Steering Assist
- + Pre-Collision Throttle Management
- + Integrated infotainment system featuring:
 - + 7" LCD touchscreen
 - + Apple CarPlay® and Android Auto™ connectivity³
 - + Digital radio⁴ (DAB+)
 - + Satellite navigation
- + Multi-Function Display unit (MFD) with 5.9" LCD touchscreen
- + Rear view reverse camera
- + USB connections (x2)
- + Vision Assist featuring:
 - + Blind Spot Monitor (BSM)
 - + EyeSight® Assist Monitor
 - + Front View Monitor (FVM)
 - + High Beam Assist (HBA)
 - + Lane Change Assist (LCA)
 - + Rear Cross Traffic Alert (RCTA)
 - + Side View Monitor (SVM)

Explore the range at subaru.com.au/levorg

1. Some parts of the seating or trim are not full natural leather. 2. Bluetooth® is a registered trademark of Bluetooth SIG Inc. System functionality is subject to the Bluetooth® wireless technology specification of individual device. 3. Compatible Apple® or Android™ device required. 4. Digital radio station coverage dependent on vehicle location.



Levorg 2.0 STI Sport AWD

turbocharged luxury

Subaru's Levorg Sportswagon packs more into everyday – driving tech, luxury and legroom – with plenty of space left over. Not just a high performance model, it's designed for comfort: dual zone climate control air-con, electric lumbar support (on every variant except Levorg 1.6 GT AWD) and extra legroom.

A large LCD touchscreen infotainment unit keeps you entertained and connected, puts music and handsfree calls at your fingertips and pumps it through six speakers. The leather steering wheel with audio, EyeSight® and Bluetooth®¹ controls puts you well and truly in the driver's seat.



Infotainment system
Levorg 1.6 GT AWD



Push-start ignition
All Levorg variants



Heated front seats
Levorg 1.6 GT Premium AWD,
2.0 GT-S AWD and 2.0 STI
Sport AWD



USB charge port - rear (x2)
All Levorg variants



1. Bluetooth® is a registered trademark of Bluetooth SIG Inc. System functionality is subject to the Bluetooth® wireless technology specification of individual device.

be inspired

Interior

On the inside Levorg 1.6 GT AWD features black cloth while Levorg 1.6 GT Premium AWD and 2.0 GT-S AWD both feature black leather¹. Maroon and black leather¹ is standard on the Levorg 2.0 STI Sport AWD.



Cloth
Black



Leather
Black



Leather
Maroon and Black

Exterior

The colour you choose for your Subaru makes a bold statement about who you are. So we've made sure you've got lots of ways to express yourself – with a wide range of colours to make your Subaru more... you.

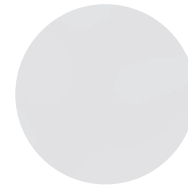

Crystal White
Pearl

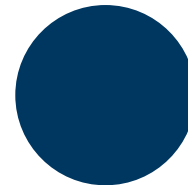

Lapis Blue
Pearl

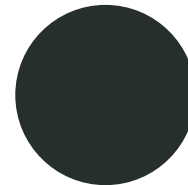

Dark Grey
Metallic

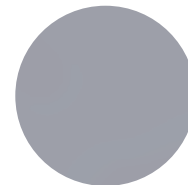

Ice Silver
Metallic (Excluding Levorg
2.0 STI Sport AWD)

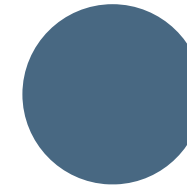

Storm Grey
Metallic

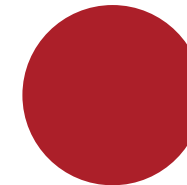

Pure Red

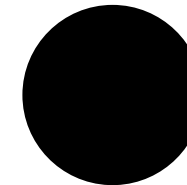

Crystal Black
Silica

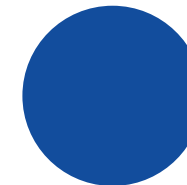

WR Blue
Pearl (Levorg 2.0 STI
Sport AWD only)

**Levorg 2.0
GT-S AWD**

1. Some parts of the seating or trim are not full natural leather.

Note: Paint colours are representative only and subject to variation due to the printing process.

why Levorg?

Symmetrical force of power

Our All-Wheel Drive philosophy

Greater balance and control. That's the confidence you get from our unique Symmetrical All-Wheel Drive (AWD) system, which delivers the drive distribution to all four wheels, all the time. Every Subaru Levorg has an innate sense of balance from the ground up, thanks to a near perfect symmetrical layout.

Boxing clever

Our famous Subaru Boxer engine

While most engines stand vertically, ours lay flat. The famous Subaru Boxer engine helps to deliver better handling. Sitting horizontally in the engine bay, it moves like a boxer's fists with a punch and counterpunch action. Lightweight, low and flat, it makes for perfect balance and a much lower centre of gravity. It creates less noise and vibration too. All of this means better on-road handling for you. More stability. More performance. More fun. And a more confident drive.

DataDotDNA®

Every Subaru is fitted with advanced engine immobilisers and the DataDotDNA®¹ Theft Deterrent System. Microscopic dots are laser-etched with each vehicle's unique Vehicle Identification Number – making it a less attractive target for thieves.

Three Year Rebate on Theft Insurance Excess

DataDot Technology (Australia) Pty Ltd will pay your theft insurance excess² (up to a maximum of \$800 including GST) should your new Subaru be stolen in the first three years of purchase and not recovered within 45 days despite the presence of DataDotDNA®¹ and warning labels.

Finest safety

5 star ANCAP safety across the Levorg range

With spirit, quality and imagination comes some serious safety innovation. We want every Subaru Levorg to be amongst the safest cars on the road. Engineered full of cutting-edge technologies and the most intelligent design features. The Subaru Levorg carries the maximum 5 star ANCAP³ safety rating.

Eyes in the back of your head

Rear view reverse camera and smart rear view mirror

Manoeuvring back into a tight side street? Family driveway littered with toys? Reverse with confidence, thanks to our rear view reverse camera technology. The rear view reverse camera is like having eyes in the back of your head. This greatly improves your visibility and reduces the risk of bumps and scrapes. The rear view reverse camera comes standard across the Levorg range.

For those times when you are travelling with a full boot, our smart rear view mirror with built-in LCD monitor displays images from a camera

1. DataDotDNA® is a theft deterrent not a theft prevention mechanism. 2. Vehicles must be registered, comprehensively insured and less than 3 years old. DTA must receive a claim within 45 days of the theft. Terms and conditions apply. 3. The Australasian New Car Assessment Program (ANCAP) gives consumers consistent information on the level of occupant protection provided by vehicles in serious front and side crashes.

mounted at the rear of the Levorg. This means you can see the traffic behind you, even if you are carrying a full load. This clever tech is available on Levorg 1.6 GT Premium AWD, 2.0 GT-S AWD and 2.0 STI Sport AWD.

Yet another world first

Lineartronic® CVT

Pushing innovation beyond the bounds, we introduced an automatic transmission called Lineartronic® Continuously Variable Transmission (CVT). And it's the reason our automatic models drive so smooth. It's the world's first longitudinally mounted system for AWD vehicles. Unlike a conventional automatic transmission – which uses fixed gear ratios – our Lineartronic® CVT provides infinite variability between the highest and lowest available ratios. So you now experience a smoothness that also optimises the efficiency of the vehicle. For even more excitement, switch to manual mode for greater control to suit your driving style. Lineartronic® CVT is available across the Subaru Levorg range.

Intelligently driven

Subaru Intelligent Drive

Heading to the shops? Taking on the Great Ocean Road? Each situation deserves a distinctive driving mode, so we crafted Subaru Intelligent Drive (SI-Drive) technology to do just that. Switch from smart, to sporty to even sportier. Intelligent (I) mode – perfect for everyday driving, Sport (S) mode – for enhanced acceleration and all-round sporty performance

and on the Levorg 2.0 GT-S AWD and 2.0 STI Sport AWD variants, Sport Sharp (S#) mode – for a truly thrilling drive.

We're looking out for you

EyeSight® Driver Assist

We were the first car company to exclusively use stereo camera technology to detect objects in our vehicles path. A sign of our future-thinking and our commitment to quality, technology and safety, EyeSight® Driver Assist is like your second pair of eyes, spotting potentially dangerous situations. If EyeSight® detects anything that might be of danger, it warns you audibly, urging you to take action and brake. EyeSight® Driver Assist is standard across the Levorg range.

Clever thinking

Vision Assist

Imagine if your side mirrors could alert you when there's something in your blind spot. Or if your high beams could automatically switch to low beam, when approaching oncoming traffic at night. We made all this happen – and more – with Subaru's Vision Assist. Our suite of proactive safety technologies including Side View Monitor, Blind Spot Monitor, Rear Cross Traffic Alert, Lane Change Assist, High Beam Assist and Front View Monitor are always at work to help you feel safer on the road. Subaru's Vision Assist technologies are standard on the Levorg 1.6 GT Premium AWD, 2.0 GT-S AWD and 2.0 STI Sport AWD.





Levorg 2.0 STI Sport AWD

Subaru Levorg specifications¹

MODEL		1.6 GT AWD	1.6 GT Premium AWD	2.0 GT-S AWD	2.0 STI Sport AWD
		Wagon	Wagon	Wagon	Wagon
Transmission					
Lineartronic® CVT		•	•	•	•
Engine					
Bore x stroke	mm	78.8 x 82.0		86.0 x 86.0	
Capacity	cc	1599		1998	
Compression ratio		11.0:1		10.6:1	
Engine type		Direct Injection turbocharged horizontally-opposed Boxer 4-cylinder, petrol engine			
Fuel requirement (min)	RON	95			
Fuel system		Direct injection			
Fuel tank capacity	litres	60			
Valve mechanism		DOHC with Dual AVCS			
Performance²					
CO ₂ emissions (ADR 81/02)	combined	(g/km)	169	201	
Electronic Throttle Control system (ETC)			Drive-by-wire		
Fuel consumption (ADR 81/02) For comparison purposes only. Real world results may vary ³ :					
	combined	l/100km	7.4	8.7	
	extra urban	l/100km	6.5	6.9	
	urban	l/100km	8.8	11.8	
Maximum power output (DIN)		kW/rpm	125kW@4800-5600rpm	197kW@5600rpm	
Maximum torque (DIN)		Nm/rpm	250Nm@1800-4800rpm	350Nm@2400-5200rpm	
Symmetrical All-Wheel Drive (AWD)					
Type	Auto	Active Torque Split		Variable Torque Distribution	
Transmission					
Final reduction gear ratio		3.900			
Gear ratio	1st	3.560		3.505 (S#:3.505)	
	2nd	2.255		2.238 (S#:2.405)	
	3rd	1.655		1.641 (S#:1.855)	
	4th	1.201		1.194 (S#:1.544)	
	5th	0.887		0.880 (S#:1.258)	
	6th	0.616		0.611 (S#:1.032)	
	7th			(S# 0.856)	
	8th			(S# 0.716)	
Gear ratio – reverse		3.667		2.345	

1. Subaru Australia reserves the right to change mechanical specification and equipment levels without notice. 2. All performance data measured using 95RON as required by Australian Design Rule 81/02. Vehicles tested in accordance with ADR 81/02. 3. Fuel consumption figures quoted are measured in accordance with Australian Design Rule 81/02 and are for comparison purposes only. Real world results may vary based on individual driving circumstances e.g. traffic conditions, driving style, vehicle conditions, fuel quality, climatic conditions etc. Quoted figures may not reflect real world fuel consumption.

Subaru Levorg specifications¹

MODEL		1.6 GT AWD	1.6 GT Premium AWD	2.0 GT-S AWD	2.0 STI Sport AWD
		Wagon	Wagon	Wagon	Wagon
Steering					
Minimum turning circle	m	10.8			
Type		Electric power assistance rack and pinion			
Suspension					
Type	Front	MacPherson strut, lower L-arms, coil springs, stabiliser bar	Bilstein® MacPherson strut, lower L-arms, coil springs, stabiliser bar		
	Rear	Double wishbone, coil springs, stabiliser bar	Bilstein® damper, coil springs, double wishbone, stabiliser bar		
Brakes					
ABS		4-channel, 4-sensor ABS with Electronic Brakeforce Distribution and VDC			
Brake booster type		Tandem			
Type	Front	Ventilated disc brakes			
	Rear	Ventilated disc brakes			
Wheels and Tyres					
Rim size		17x7J	18x7.5J		
Spare wheel		Temporary spare wheel			
Tyre manufacturer		Dunlop SP Sport Maxx 050			
Tyres (width, profile, size, load index and speed rating)		215/50R17 91V	225/45 R18 91W		
Wheels		17"	18"		
Measurement					
Cargo volume – rear seat up/down	litres	489/911 (1413 to ceiling)			
Front track	mm	1530			
Minimum ground clearance ²	mm	130	135		
Overall height	mm	1485	1490		
Overall length	mm	4690			
Overall width	mm	1780			
Rear track	mm	1540			
Seating capacity		5			
Tare mass ³	kg	1539	1580	1591	1591
Wheel base	mm	2650			
Towing					
Maximum tow ball down load	kg	80	80	150	120
With trailer brakes (max)	kg	800	800	1500	1200
Without trailer brakes (max)	kg	750			

1. Subaru Australia reserves the right to change mechanical specification and equipment levels without notice. 2. Ground clearance at kerb weight. 3. Vehicle tare mass varies according to the types of optional equipment included.

Subaru Levorg features¹

MODEL	1.6 GT AWD	1.6 GT Premium AWD	2.0 GT-S AWD	2.0 STI Sport AWD
Transmission				
Lineartronic® CVT	•	•	•	•
Safety Rating				
5 star ANCAP ² safety rating (maximum 5)	•	•	•	•
Collision Avoidance				
Symmetrical All-Wheel Drive (AWD)	•	•	•	•
4-wheel disc brakes	•	•	•	•
Auto Vehicle Hold (AVH)	•	•	•	•
Electronic parking brake	•	•	•	•
Rear view reverse camera	•	•	•	•
Vehicle Dynamics Control system (VDC) featuring:	•	•	•	•
Active Torque Vectoring System	•	•	•	•
Anti-lock Braking System (ABS)	•	•	•	•
Brake Assist	•	•	•	•
Electronic Brakeforce Distribution (EBD)	•	•	•	•
Electronic Stability Control (ESC)	•	•	•	•
Traction Control System (TCS)	•	•	•	•
Vision Assist featuring:	•	•	•	•
Blind Spot Monitor (BSM)	•	•	•	•
EyeSight® Assist Monitor	•	•	•	•
Front View Monitor (FVM)	•	•	•	•
High Beam Assist (HBA)	•	•	•	•
Lane Change Assist (LCA)	•	•	•	•
Rear Cross Traffic Alert (RCTA)	•	•	•	•
Side View Monitor (SVM)	•	•	•	•
Collision Protection				
3 point A/ELR rear seat belts	•	•	•	•
Front seat belts with pretensioners and load limiters	•	•	•	•
Height adjustable rear seat headrests for 3 seating positions	•	•	•	•
Height adjustable seat belt anchors – driver and front passenger	•	•	•	•
Height and angle adjustable front seat headrests	•	•	•	•
Ring-shaped passenger safety cell	•	•	•	•
Seat belt warning lights – all seats	•	•	•	•
SRS ³ airbags – dual front, dual front side, dual curtain and driver's knee	•	•	•	•

1. Subaru Australia reserves the right to change mechanical specification and equipment levels without notice. 2. The Australasian New Car Assessment Program (ANCAP) gives consumers consistent information on the level of occupant protection provided by vehicles in serious front and side crashes. 3. SRS: Supplemental Restraint System. Effective when used in conjunction with seat belts.

Subaru Levorg features¹

MODEL	1.6 GT AWD	1.6 GT Premium AWD	2.0 GT-S AWD	2.0 STI Sport AWD
Child Safety				
Child seat anchor points (x3)	•	•	•	•
ISOFIX anchor points (x2)	•	•	•	•
Rear door child locks	•	•	•	•
Intelligent Driving Dynamics				
Auto Stop Start	•	•		
Bilstein® suspension		•	•	With STI coil springs
Electronic Throttle Control system (ETC)	•	•	•	•
EyeSight® Driver Assist system featuring:	•	•	•	•
Adaptive Cruise Control	•	•	•	•
Brake Light Recognition	•	•	•	•
Lane Departure Warning	•	•	•	•
Lane Keep Assist	•	•	•	•
Lane Sway Warning	•	•	•	•
Lead Vehicle Start Alert	•	•	•	•
Pre-Collision Brake Assist	•	•	•	•
Pre-Collision Braking System	•	•	•	•
Pre-Collision Steering Assist	•	•	•	•
Pre-Collision Throttle Management	•	•	•	•
Subaru Intelligent Drive (SI-Drive):	•	•	•	•
Intelligent (I) mode	•	•	•	•
Sport (S) mode	•	•	•	•
Sport Sharp (S#) mode			•	•
Chassis and Mechanism				
Front and rear stabiliser	•	•	•	•
Tie-rod type tandem brake booster system	•	•	•	•
Exterior				
17" alloy wheels	•			
18" alloy wheels		•	•	•
Body coloured mirrors and door handles	•	Silver mirrors	Silver mirrors	Silver mirrors
Bonnet scoop	•	•	•	•
Bonnet with gas struts	•	•	•	•
Chrome type rear garnish and window sills	•	•	•	•
Chrome type inserts on door handles				•
Detachable module type windscreen wipers	•	•	•	•

1. Subaru Australia reserves the right to change mechanical specification and equipment levels without notice.

Subaru Levorg features¹

MODEL	1.6 GT AWD	1.6 GT Premium AWD	2.0 GT-S AWD	2.0 STI Sport AWD
Door mirrors:	•	•	•	•
Body coloured	•	•	•	•
Heated	•	•	•	•
Indicators	•	•	•	•
Power-folding	•	•	•	•
Dual tail pipes with covers	•	•	•	With STI stamp
Electric sunroof		•	•	•
Engine cover	•	•	•	•
Front and rear wipers	•	With de-icer	With de-icer	With de-icer
Rear spoiler	•	•	•	•
Roof carrier brackets	•	•	•	•
Shark fin antenna	•	•	•	•
Side sill skirts	•	•	•	•
Silver brake calipers	•	•	•	•
Lighting – Exterior				
Daytime Running Lights – LED	•	•	•	•
Front fog lights – LED	•	•	•	•
Headlights – self-levelling LED with auto off (dusk-sensing)	•	•	•	•
Rear bumper reflectors	•	•	•	•
Rear fog light	•	•	•	•
Rear combination lights and Rear LED stoplight	•	•	•	•
Steering Responsive Headlights (SRH)	•	•	•	•
Lighting – Interior				
Cabin and cargo area lights	•	•	•	•
Map lights (x2)	•	•	•	•
Air-conditioning				
Anti-dust filter	•	•	•	•
Dual zone climate control	•	•	•	•
Floor heater ducts for rear passengers	•	•	•	•
Front and side demisters	•	•	•	•
Rear windscreen demister – electric with timer	•	•	•	•
Security				
DataDotDNA ^{®2} security system	•	•	•	•
Immobiliser security system	•	•	•	•

1. Subaru Australia reserves the right to change mechanical specification and equipment levels without notice. 2. DataDotDNA[®] is a theft deterrent not a theft prevention mechanism.

Subaru Levorg features¹

MODEL	1.6 GT AWD	1.6 GT Premium AWD	2.0 GT-S AWD	2.0 STI Sport AWD
Instrumentation and Controls				
Adjustable steering wheel – height and telescopic	•	•	•	•
Electroluminescent gauges with colour MID	•	•	•	•
Hazard warning indicators	•	•	•	•
Instrument cluster	•	•	•	•
Manual mode	•	•	•	•
One touch lane change indicator	•	•	•	•
Paddle gear shifters	•	•	•	•
Sports pedals	•	•	•	•
Steering wheel controls:	•	•	•	•
Audio	•	•	•	•
Bluetooth ^{®2}	•	•	•	•
EyeSight [®]	•	•	•	•
MID	•	•	•	•
SI-Drive	•	•	•	•
Twin trip meter (switchable)	•	•	•	•
Multi-Function Displays				
MFD visor with stitching		Blue stitching	Blue stitching	Red stitching
Multi-Function Display unit (MFD) featuring:	•	•	•	•
5.9" LCD screen	•	•	•	•
Air-conditioning and seat belt display	•	•	•	•
Front View Monitor display		•	•	•
Fuel economy and journey information	•	•	•	•
Outside temperature and clock display	•	•	•	•
Preventative Safety display	•	•	•	•
Side View Monitor display		•	•	•
Turbo boost pressure display			•	•
Multi-Information Display unit (MID) featuring:	•	•	•	•
3.5" LCD screen	•	•	•	•
Auto Stop Start information	•	•		
Digital speedometer	•	•	•	•
Eco-gauge information	•	•	•	•
EyeSight [®] display	•	•	•	•
Journey information	•	•	•	•
SI-Drive display	•	•	•	•
Warning display	•	•	•	•

1. Subaru Australia reserves the right to change mechanical specification and equipment levels without notice. 2. Bluetooth[®] is a registered trademark of Bluetooth SIG Inc. System functionality is subject to the Bluetooth[®] wireless technology specification of individual device.

Subaru Levorg features¹

MODEL	1.6 GT AWD	1.6 GT Premium AWD	2.0 GT-S AWD	2.0 STI Sport AWD
Storage				
Cargo hooks	•	•	•	•
Centre console box with sliding armrest	•	•	•	•
Cupholders – centre console (with sliding lid) and rear	•	•	•	•
Door pockets with integrated bottle holder – front and rear	•	•	•	•
Front centre tray	•	•	•	•
Pull-out cargo area tie down points	•	•	•	•
Retractable cargo blind	•	•	•	•
Seat back pocket – driver and front passenger side	•	•	•	•
Convenience				
12V/120W power jacks (x2)	•	•	•	•
Auto-dimming rear view mirror		•	•	•
Boot/tailgate unlock on remote central locking keys	•	•	•	•
Interior fuel lid lock release	•	•	•	•
Intermittent variable speed front windscreen wipers	•	•	•	•
Power mirrors and windows – all with auto function	•	•	•	•
Power steering	•	•	•	•
Rain-sensing front windscreen wipers	•	•	•	•
Rear seat centre armrest	•	•	•	•
Remote central locking keys (x2)	•	•	•	•
Remote central locking – selective unlock	•	•	•	•
Smart key and push-start ignition	•	•	•	•
Smart rear view mirror		•	•	•
Sunvisors with illuminated vanity mirrors – driver and front passenger	•	•	•	•
USB charge port – centre console (x2) and rear passengers (x2)	•	•	•	•
Interior Trims				
Carpet trim – black	•	•	•	•
Leather steering wheel and gear shift	With silver stitching	With blue stitching	With blue stitching	With red stitching
Seat trim – black cloth	•			
Seat trim – black leather ²		•	•	
Seat trim – maroon and black leather ²				•
Shift boot	•	•	•	•
Side sill plates (front) – stainless		With Subaru logo	With Subaru logo	With STI logo
Sports bucket seats – driver and front passenger		With blue stitching	With blue stitching	With red stitching

1. Subaru Australia reserves the right to change mechanical specification and equipment levels without notice. 2. Some parts of the seating or trim are not full natural leather.

Subaru Levorg features¹

MODEL	1.6 GT AWD	1.6 GT Premium AWD	2.0 GT-S AWD	2.0 STI Sport AWD
Seating Extras				
40/20/40 split folding rear seats	•	•	•	•
8-way power seat with dual memory – driver		•	•	•
Electric lumbar support – driver		•	•	•
Heated seats – driver and front passenger		•	•	•
Manual seat height lifter – driver	•			
One touch electric folding rear seats	•	•	•	•
Reclining rear seat	•	•	•	•
Entertainment				
Auxiliary jack – front centre console	•	•	•	•
<i>Bluetooth</i> ² wireless technology with:	•	•	•	•
Handsfree mobile communication	•	•	•	•
Audio streaming ³	•	•	•	•
Integrated infotainment system featuring:	•	•	•	•
6 speakers	•	•	•	•
6.5" LCD touchscreen	•			
7" LCD touchscreen		•	•	•
AM/FM radio	•	•	•	•
Apple CarPlay [®] and Android Auto [™] connectivity ⁴	•	•	•	•
Digital radio ⁵ (DAB+)	•	•	•	•
Satellite navigation		•	•	•
Single CD player	•	•	•	•
Siri ^{®6} compatibility		•	•	•
USB connection/s	x1	x2	x2	x2
Voice command recognition	•	•	•	•
Owner Benefits				
5 Year/Unlimited Km Warranty	•	•	•	•
5 Year/125,000 Km Capped Price Servicing Program ⁷	•	•	•	•
12 Month Roadside Assistance Program ⁸	•	•	•	•

1. Subaru Australia reserves the right to change mechanical specification and equipment levels without notice. 2. *Bluetooth*[®] is a registered trademark of Bluetooth SIG Inc. System functionality is subject to the *Bluetooth*[®] wireless technology specification of individual device. 3. There may be restrictions on features available for certain models that are not fully compliant with AVCRP. 4. Compatible Apple[®] or Android[™] device required. 5. Digital radio station coverage dependent on vehicle location. 6. Requires compatible Siri[®] enabled Apple[®] device to be paired with the infotainment system. 7. Every eligible Model Year 2018 onward Subaru Levorg comes with Subaru's 5 Year/125,000 Km Capped Price Servicing Program. Available at participating Subaru Retailers only and does not apply to rental and some other classes of vehicles. For full Capped Price Servicing Terms and Conditions visit www.subaru.com.au/service/pricing/capped-price-servicing. 8. 12 Month Roadside Assistance Program is standard upon activation with relevant Motoring Club in each state. To receive this benefit the customer must opt into the 12 Month Roadside Assistance program at time of vehicle delivery. Eligible customers are those retail and novated lease customers who purchase a new Subaru on or after 1st June 2013 and have less than 5 vehicles under the Club Membership offer. Customers must provide a valid phone and residential address, as well as date of birth. Fleet, Government and Rental companies are excluded.

do it your way

Turbocharge your everyday your way, with a huge range of Genuine Subaru Accessories designed to fit your Subaru Levorg Sportswagon perfectly. Style it up, spec it up and pack more in.

From action-packed to packing the back, we've got accessories for everything you'll do with your Subaru Levorg.

- + Styling Tailor your Levorg to your personal fit with a range of stylish interior and exterior options.
- + Protection Protecting your Levorg is easy, with tailor-made genuine accessories that fit like a glove. Our range of protection accessories will fend off spills, bumps and scrapes.
- + Cargo Rig up your Levorg with a tow bar package as well as a wide range of quality Thule sport and cargo accessories, bike and kayak mounts.
- + Security, Convenience and Safety Light up your world with our rear tailgate lighting kit. Keep your new wheels secure with a security car alarm system. The compact, windscreen mounted Garmin Dash Cam records sharp video; gives the driver a range of alerts and can be synced to your smartphone.
- + STI Performance Parts Tweak the performance of your Levorg for that extra edge. Bring out the beast with performance parts for optimum handling and control. Or spiff it up with aerodynamic spoilers and STI ENKEI performance alloy wheels.

Genuine Subaru Accessories are available from your Subaru Retailer, so be sure to ask about the range when buying your new Subaru Levorg.

 To view our complete range of accessories and pricing online visit subaru.com.au/levorg/accessories





Levorg 2.0 GT-S AWD



Levorg 2.0 GT-S AWD

packs that will inspire you

From action-packed to packing the back, these quality Genuine Subaru Accessory Packs will give you the protection you need and versatility you desire to do more with your Subaru Levorg.

Both stylish and functional, each Accessory Pack has been custom made for a tailored fit to complement your Subaru Levorg and keep it looking good for years to come.

Plus all Genuine Subaru Accessories are protected by our manufacturer's warranty¹.

Protection Pack includes:

a Carpet Mat Set

Enjoy the comfort with a luxurious Levorg branded quality carpet mat set.

b Cargo Tray

Throw all the gear in the back with a heavy duty mat to protect the cargo area from dust and dirt.

c Cargo Step Panel (Resin)

Grab your gear and go without worrying about scratching the rear top face of the bumper with a tailored resin panel.

d Weather Shields

Sleekly designed and tailored to fit onto each door individually.

Explorer Pack includes:

Add a Tow Bar to the Protection Pack to squeeze more out of your everyday.

e Tow Bar

Hook your toys up to a functional and sturdy tow bar engineered specifically for the Australian market.



1. For full warranty terms and conditions, visit [subaru.com.au/accessories-information/warranty](https://www.subaru.com.au/accessories-information/warranty)

do it up

Make your Subaru Levorg a genuine one-off. Splash out with colour and style options to enhance the cabin and highlight the vehicle's sporty exterior lines.

ACCESSORY	Part Number	1.6 GT AWD	1.6 GT Premium AWD	2.0 GT-S AWD	2.0 STI Sport AWD
Styling					
1 Side Sill Plate (Available in Blue (shown) and Red)	E1010VA200	•	•	•	•
2 Alloy Wheel Set 18" (Available in Blue (shown) and Red)	B3110VA600K	•	•	•	•
3 Front Grille (Mesh Type)	J1010VA300##			•	
4 Front Spoiler ¹	E2410VA210NN	•	•	•	
5 Roof Spoiler ¹ (cannot be fitted with STI Roof End Spoiler)	E7210VA200NN	•	•	•	•
6 Rear Under Diffuser (cannot be fitted with STI Rear Under Spoiler)	E5610VA200	•	•	•	•
7 Rear Under Spoiler (Not applicable with Tow Bar)	E5610VA600##	•	•	•	•
8 Waist Spoiler	J1210VA010NN	•	•	•	•
9 Matte Carbon Dash Panel Interior Trim (Available in Blue (shown) and Bordeaux)	J1310VA070	•	•	•	•
10 Side Stripe (Available in Blue (shown), Red, White and Black)	J1210VA300	•	•	•	•
11 Door Mirror Stripe (Available in Blue (shown), Red, White and Black)	J1210VA360	•	•	•	•

1. Includes painting in RRP Fitted Price.
Denotes colour option of your choice.

To view our complete range of accessories and pricing online visit subaru.com.au/levorg/accessories

	Not Applicable
•	Applicable





protect your investment

Get out and do more while protecting your Subaru Levorg from the rough and tumble of daily life. From our cargo tray to our bumper protector, each accessory is tailored for a perfect fit.

ACCESSORY	Part Number	1.6 GT AWD	1.6 GT Premium AWD	2.0 GT-S AWD	2.0 STI Sport AWD
Protection					
12 Carpet Mat Set	J501AVA300	•	•	•	•
13 Rubber Mat Set	J5010VA100	•	•	•	•
14 Body Side Moulding (Non-coloured)	J1010VA600NN	•	•	•	•
15 Aero Mud Guards (Front)	J1010VA001NN	•	•	•	•
16 Aero Mud Guards (Rear)	J1010VA004NN	•	•	•	•
17 Weather Shields	F0010VA000	•	•	•	•
18 Cargo Step Panel (Stainless)	E7710VA000	•	•	•	•
19 Cargo Step Panel (Resin)	E7710VA010	•	•	•	•
20 Bootlip and Bumper Protector	SAT6003	•	•	•	•
Cargo and Tow					
21 Cargo Tray	J515EVA000	•	•	•	•
22 Cargo Mat – carpet	J5010VA350	•	•	•	•
23 Cargo Room Net (Side x2)	F551EVA000	•	•	•	•

 To view our complete range of accessories and pricing online visit subaru.com.au/levorg/accessories

pack it all in

Tow it, stow it or just pack more into your every day with a wide range of Subaru Levorg compatible cargo options, plus premium Thule sport and cargo carrier accessories.

ACCESSORY	Part Number	1.6 GT AWD	1.6 GT Premium AWD	2.0 GT-S AWD	2.0 STI Sport AWD
Cargo and Tow					
24 Tow Bar ¹	L101AVA010	•	•	•	•
25 Roof Cross Bars	SAT3015	•	•	•	•
26 Roof Cross Bars - Wingbar Edge (Black)	SAT3016	•	•	•	•
Thule Roof Attachments and Accessories (Roof Cross Bars Required)					
27 Bicycle Holder (Fork Mounted)	SA1042	•	•	•	•
28 Ski Holder – 4 Pair	SAT9012	•	•	•	•
29 Ski Holder – 6 Pair	SAT9013	•	•	•	•
30 Surfboard Carrier	SA1139	•	•	•	•
31 Xtender 6 Pair Ski Holder	SA1156	•	•	•	•
32 Deluxe Ski Carrier – 4 Pair	SAT8023	•	•	•	•
33 Deluxe Ski Carrier – 6 Pair	SAT8024	•	•	•	•
34 Kayak Carrier – Dockglide	SAT9018	•	•	•	•
35 Thule Paddleboard & Mal Carrier	SAT8016	•	•	•	•

1. Tow capacity varies across the Levorg range: 1.6 GT AWD and 1.6 GT Premium AWD = 800kgs, 2.0 GT-S AWD = 1,500kgs and 2.0 STI Sport AWD = 1,200kgs. Rear Under Spoiler (E5610VA600##) not applicable with fitment of Tow Bar.

 To view our complete range of accessories and pricing online visit subaru.com.au/levorg/accessories

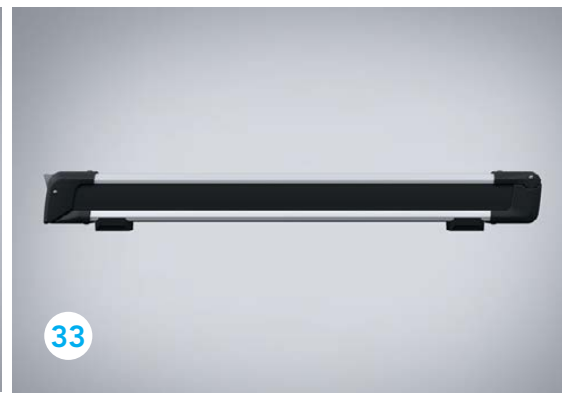
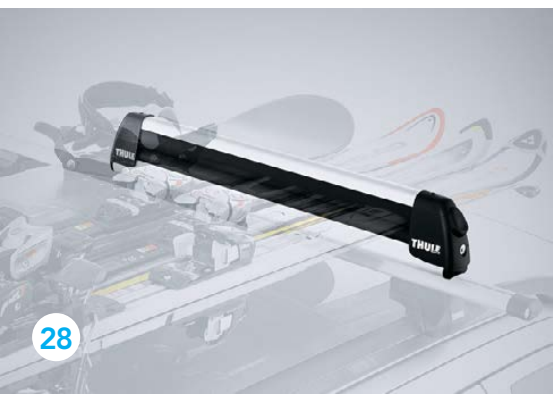

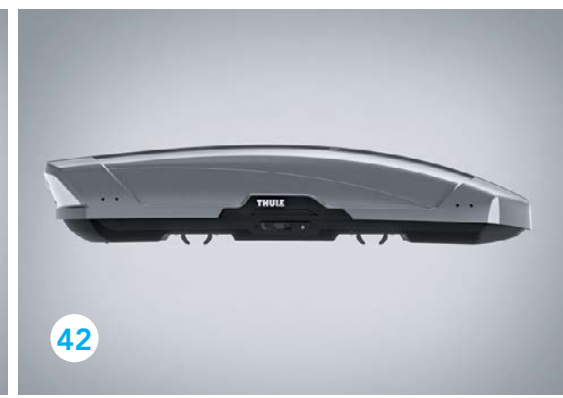

ACCESSORY		Part Number	1.6 GT AWD	1.6 GT Premium AWD	2.0 GT-S AWD	2.0 STI Sport AWD
Thule Roof Attachments and Accessories (Roof Cross Bars Required)						
36	Bicycle Holder – Silver (Upright)	SAT8018	•	•	•	•
37	Bicycle Holder – Black (Upright)	SAT8019	•	•	•	•
38	Luggage Pod Touring 100 (Titan Aeroskin) Textured Finish (Small)	SAT5008	•	•	•	•
39	Luggage Pod Touring 100 (Black Glossy) Smooth Finish (Small)	SAT5008B	•	•	•	•
40	Luggage Pod Motion XT M (Glossy Silver)	SAT9014	•	•	•	•
41	Luggage Pod Motion XT M (Glossy Black)	SAT9015	•	•	•	•
42	Luggage Pod Motion XT XL (Glossy Silver)	SAT9016	•	•	•	•
43	Luggage Pod Motion XT XL (Glossy Black)	SAT9017	•	•	•	•
44	Thule Go Box	SAT8005	•	•	•	•
45	Thule Go Pack Set (4 Bags)	SAT8006	•	•	•	•
46	Side Wheel Step Up	SAT9004	•	•	•	•
Tow Bar Attachments (Tow Bar Required)						
47	Thule Tow Bar Mounted Bike Carrier (Two Bikes) ¹	SAP925	•	•	•	•
48	Thule Tow Bar Mounted Bike Carrier (Three Bikes) ¹	SAP927	•	•	•	•

1. Fitment of Tow Bar required.



To view our complete range of accessories and pricing online visit subaru.com.au/levorg/accessories

relax, we've thought of everything

From the simplest wheel lock nuts, to a rear tailgate lighting kit, you can be sure we have you covered.

ACCESSORY	Part Number	1.6 GT AWD	1.6 GT Premium AWD	2.0 GT-S AWD	2.0 STI Sport AWD
Security					
49 Wheel Lock Nuts	B327EYA000	•	•	•	•
Convenience and Safety					
50 Round Type Ashtray (Black)	92172AG040	•	•	•	•
51 Rear Tailgate Light	H4610VA010	•	•	•	•
52 Cigarette Lighter	H6710FJ000	•	•	•	•
53 Ash Tray Holder	F6010AG010	•	•	•	•
54 First Aid Kit	PR7670	•	•	•	•
55 Safety Triangle	SAT9007	•	•	•	•
56 Garmin Dash Cam 55	0100175011	•	•	•	•
57 Magnetic Mount (additional)	0101253000	•	•	•	•
STI Performance Parts					
58 STI Front Under Spoiler	E2410VA020				•
59 STI Front Under Spoiler	E2410VA040	•	•	•	
60 STI Side Under Spoiler	E2610VA110	•	•	•	•
61 STI Rear Side Under Spoiler	E5610VA500	•	•	•	•

 To view our complete range of accessories and pricing online visit subaru.com.au/levorg/accessories



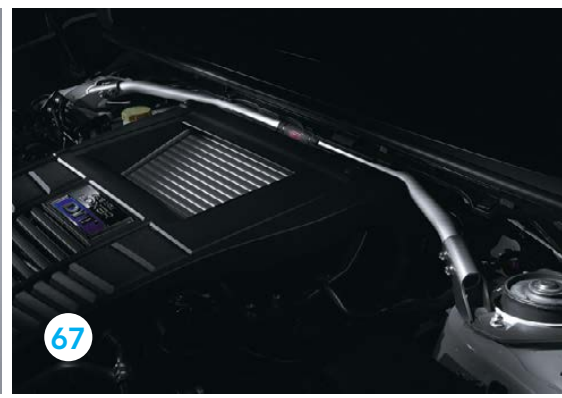

kick it into overdrive

Show your allegiance with bold, branded accessories to protect and style your new Subaru Levorg.

ACCESSORY	Part Number	1.6 GT AWD	1.6 GT Premium AWD	2.0 GT-S AWD	2.0 STI Sport AWD
STI Performance Parts					
62 STI Rear Under Spoiler (cannot be fitted with Rear Under Diffuser)	E5610VA360	•	•	•	•
63 Roof End Spoiler (cannot be fitted with Roof Spoiler)	ST96050VV320	•	•	•	•
64 STI ENKEI Alloy Wheel Set (4) – 18x7.5 (Silver)	B3110AL031K	•	•	•	•
65 STI ENKEI Alloy Wheel Set (4) – 18x7.5 (Gun Metal)	B3110AL041K	•	•	•	•
66 STI ENKEI Alloy Wheel Set (4) – 18x7.5 (Black)	B3110AL051K	•	•	•	•
67 Flexible Tower Bar	ST20502VV030A	•	•	•	•
68 Push-Start Engine Switch (Red)	ST83031ST012	•	•	•	•
69 STI Leather Shift Knob (CVT)	C1010SG101	•	•	•	•
70 Security Wheel Nut Set	ST28170ST060	•	•	•	•
71 Valve Cap Set	ST28102ST030	•	•	•	•
72 Battery Clamp/Holder	ST82182ST000	•	•	•	•
73 High Pressure Radiator Cap	ST4511355010	•	•	•	•
74 Sports Oil Filter	ST15208ST010	•	•	•	•
75 Oil Cap	ST15257ZR010	•	•	•	•

 To view our complete range of accessories and pricing online visit subaru.com.au/levorg/accessories

welcome to the family

There are cars that simply get you from A to B, and then there are cars that empower you. Buying a Subaru is like embracing life with both hands and knowing that nothing is going to stop you. When you buy a new Subaru you



are welcomed into an owner's program that gives you access to a number of benefits.

Subaru New Car Warranty – 5 Year/Unlimited Kilometres

Every new Subaru purchased on or after 1st January 2019 is covered by a 5 Year/Unlimited Kilometre manufacturer's national warranty. Visit subaru.com.au/warranty or ask your Subaru Retailer for more information.

Subaru Capped Price Servicing

With our Subaru 5 Year/125,000 Kilometre Capped Price Servicing Program¹, you'll now know the maximum amount you will have to pay for your next scheduled service during

the Program period. You'll also have peace of mind knowing that specialist Subaru technicians will be looking after your pride and joy using only Genuine Subaru Parts.



DataDotDNA®

Every Subaru is fitted with advanced engine immobilisers and the DataDotDNA^{®2} Theft Deterrent System. Microscopic dots are laser-etched with each vehicle's unique Vehicle Identification Number – making it a less attractive target for thieves.

Three Year Rebate on Theft Insurance Excess

DataDot Technology (Australia) Pty Ltd will pay your theft insurance excess³ (up to a maximum of \$800 including GST) should your new Subaru be stolen in the first three years of purchase and not recovered within 45 days despite the presence of DataDotDNA^{®2} and warning labels.

1-Month Health Check and Chat

The 1-Month Health Check and Chat is a free consultation within the first month after delivery of your new Subaru. It allows our factory-trained technicians to provide quick vehicle checks, and one of our Service Advisors will answer any of your questions to help ensure an ongoing, worry-free experience.

Subaru's Map Updates

If your new Subaru is fitted with a factory line fit navigation unit your unit will be covered by Subaru's Map Update Program⁴ – guaranteeing you'll have access to the latest maps for the first 3 years of ownership.

My Subaru – online owner's destination

The My Subaru owner's portal is an online destination for owners which provides access to exclusive benefits, tailored content, your vehicle's ownership history and much more.

1. Every eligible Model Year 2018 onward Subaru Levorg comes with Subaru's 5 Year/125,000 Km Capped Price Servicing Program. Available at participating Subaru Retailers only and does not apply to rental and some other classes of vehicles. For full Capped Price Servicing Terms and Conditions visit www.subaru.com.au/service/pricing/capped-price-servicing. 2. DataDotDNA[®] is a theft deterrent not a theft prevention mechanism. 3. Vehicles must be registered, comprehensively insured and less than 3 years old. DTA must receive a claim within 45 days of the theft. Terms and conditions apply. 4. Subaru's Map Update Program is available on MY19 Subaru Levorg variants purchased from 30th July 2018 onwards with the factory line fit Gen3.1 navigation unit. Subaru's Map Update Program is not available on accessory fit or dealer sourced navigation units. For full terms and conditions of the Subaru Map Update Program visit www.subaru.com.au/owner-experience/benefits/subaru-map-update-program.

live life without limits

Login to My Subaru, the online destination for Subaru owners that will help you get more out of your vehicle, and more out of your life.

Visit my.subaru.com.au

Subaru Roadside Assistance

Enjoy 12 months of Australia-wide, standard Roadside Assistance when you purchase your new Subaru. In the unfortunate situation where you need that extra helping hand, our Roadside Assistance will help¹ with arranging a tow, battery service, flat tyre service, fuel delivery and lockout service.

Subaru Certified Collision Repairer Network

With a dedicated Subaru Certified Collision Repairer² helpline available on 1800 737 179, help is available when you need it most. Available 24-hours a day, 7 days a week, help is only a phone call away. Subaru Certified Collision Repairers guarantee that trained specialists will repair your Subaru to strict factory specifications using Genuine Subaru Parts.

Genuine Accessories

Genuine Subaru Accessories are designed to enhance your vehicle, help you get more stuff done and have more fun! Our genuine accessories are factory approved by Subaru and are protected by the Genuine Subaru Accessories Warranty. For our full range of Subaru Levorg accessories visit subaru.com.au/levorg/accessories. For warranty information visit subaru.com.au/warranty and click on "Genuine Subaru Accessories Warranty".

Subaru Finance

Subaru Finance³ provides a range of competitive financial solutions to approved customers. Our finance specialists will help you find a finance package to meet your needs conveniently.

Subaru Insurance

It's important to enjoy the freedom of owning a Subaru, but it's also important to protect it. A range of Subaru Insurance⁴ options provides a variety of choices, including: Subaru Comprehensive Motor Vehicle Insurance and Subaru Loan Protection Insurance.

Subaru Certified Used Cars

Every Subaru Certified Used Car has passed a 120-point quality inspection and comes with a one year unlimited kilometre Subaru Assured Warranty⁵ – to complement the balance of a new vehicle warranty or the statutory warranty that remains – from participating Subaru Certified Used Car Retailers.

1. 12 month Club Membership and Roadside Assistance Offer is standard upon activation with the relevant Motoring Club in each state. To receive this benefit the customer must opt into the 12 month Club Membership and Roadside Assistance Offer at time of vehicle delivery. Eligible customers are those retail and novated lease customers who purchase a new Subaru and have less than 5 vehicles under the Club Membership offer. Customers must provide a valid phone number and residential address, as well as date of birth. Fleet, Government and Rental companies are excluded. Terms and conditions apply. For a full list of benefits, visit www.subaru.com.au/owner-experience/benefits/program/roadside. 2. Subaru Certified Collision Repairer network not available in all areas. Call 1800 737 179 or visit www.subaru.com.au/retailers to find your closest Subaru Certified Collision Repairer. 3. Finance provided by Macquarie Leasing Pty Limited ABN 38 002 674 982 Australian Credit Licence Number 394925 trading as Subaru Finance. All applications for credit are subject to Macquarie's normal credit approval criteria. Terms and conditions, fees and charges apply. 4. Subaru Insurance products are issued by Allianz Australia Insurance Limited AFS Licence No. 234 708 ABN 15 000 122 850 (Allianz). In arranging this insurance Subaru (Aust) Pty Limited ABN 95 000 312 792 (Subaru) and the authorised dealers act as agents of Allianz and not as your agent. Neither Subaru nor any of its related companies or appointed authorised retailers have any liability in respect of these policies. 5. The Subaru Assured Warranty product is issued by the selling Subaru Retailer. Subaru Australia has no liability in respect of this warranty.

Subaru Levorg Awards

2016 - Australasian New Car Assessment Program 5 star ANCAP safety rating

Subaru Australia reserves the right to vary vehicle specifications and standard features in Australia from those detailed in this brochure. Vehicles shown in this brochure may be fitted with accessories available at additional cost. No part of the brochure can be reproduced without written permission from Subaru Australia. Printed in Australia.

subaru.com.au

© Copyright 2018 – Subaru (Aust) Pty Limited. All rights reserved.
Subaru (Aust) Pty Limited ABN 95 000 312 792 (Subaru Australia) PO Box 8311, Norwest NSW 2153 Toll Free: 1800 226 643



SUBARU