



The Caravelle 6.1



From accessibility to action.

The hard-wearing Caravelle Trendline is ready to get involved – on the school run, or on the commute to work. Large family? The headroom is the same for all 9 seats. Hot day? The air conditioning system reaches every seat and the tailgate provides shelter from sunshine and rain.



Highlights

- Modular seat configuration
- State-of-the-art driver assistance systems
- Power latching dual sliding doors and tailgate
- Upgraded connectivity
- Proven Volkswagen Quality



Standard equipment Caravelle Trendline.



Design

16-inch 'Clayton' alloy wheels
 H7 halogen headlights
 Radiator grille with two chrome trim strips
 Body colour bumpers, exterior mirror housing and door handles
 Heated electric folding exterior mirrors
 Chrome-coloured "Caravelle" badge next to the side turn signals

Variant

Long wheelbase
 2.0L TDI340 110kW engine
 7-speed DSG transmission
 Front-wheel drive

Cockpit

Dash panel with open stowage compartments, drink holders and lockable glove box
 Height adjust and lumbar support for driver & front passenger seat, height and longitudinal adjustment
 2 USB-C ports
 LED interior lighting with two reading lights in the roof console
 "Quadratic" cloth seat upholstery in Titanium Black
 Carpeted floor
 Sun visors with vanity mirrors

Infotainment and connectivity

"Composition Colour" 6.5" audio system with USB/AUX/SD input, Bluetooth and four loudspeakers
 App-Connect~

Passenger compartment

Sliding door left and right with sliding windows
 Power latching for sliding doors
 2-seater bench seat, 2nd row, with child seat anchors
 2-seater bench seat, 3rd row, with child seat anchors
 3-seater bench seat, 4th row
 LED interior lighting

Luggage compartment

Lifting tailgate with rear heated window and wiper
 Power latching tailgate

Air conditioning and sun protection

"Climatronic" 3-zone air conditioning system
 Sun blinds in passenger compartment
 Heat-insulating windows

Driver assistance systems

Electromechanical steering
 Driver Fatigue Detection*
 Cross Wind Assist*
 Electronic Stability Programme with brake assist system, ABS, traction control system, electronic differential lock and Hill Start Assist*
 Daytime running lights
 Automatic headlights with rain-sensing wipers
 Front Assist with City Emergency Brake (CEB)*
 Blind spot Monitoring (Side Assist) with Rear Traffic Alert*
 Multi Collision Braking System (MCB)
 Front & rear Parking Sensors*
 Rear View Camera*
 Electric childproof lock for sliding doors, lockable from the front cabin

*Safety technologies are designed to assist the driver, but should not be used as a substitute for safe driving practices.

~ App-Connect is compatible for selected apps with the latest smartphone versions of iOS and Android, active data service, optional connection cable (sold separately).



From 4-seater to 9-seater.

The versatile seating combinations in the Caravelle provide maximum flexibility – a selection of possible configurations is shown here. And the Caravelle still provides plenty of room for luggage in a matter of moments.

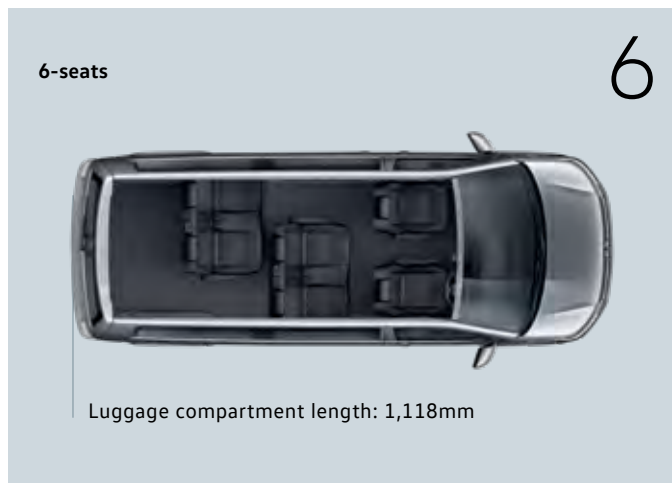
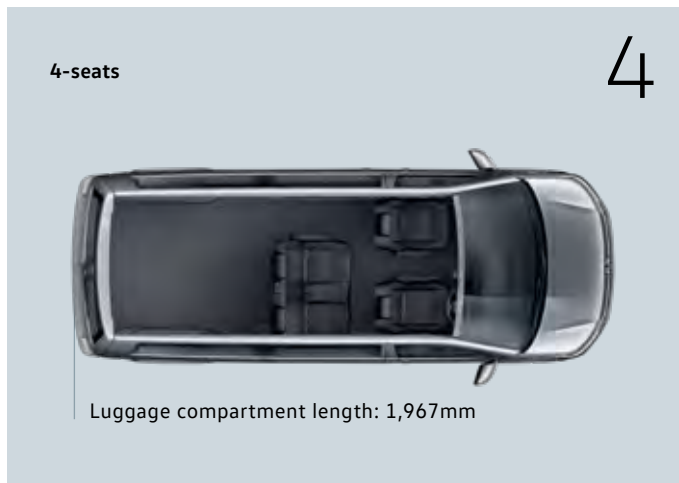
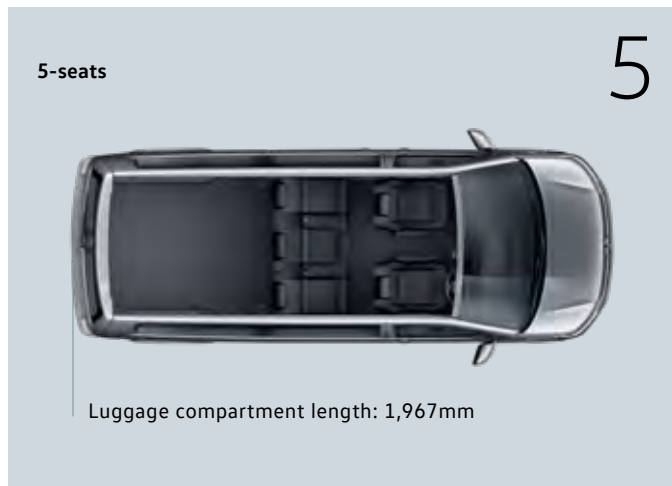



More comfort, more connectivity

The Caravelle 6.1 makes your journey as comfortable as possible with next-generation infotainment systems and a redesigned cab environment. The new infotainment systems are full touchscreen and feature redesigned graphics and App-Connect™ as standard.



01

01 Composition Colour audio system

Fitted as standard, the Composition Colour audio system features a 6.5 inch TFT touch-screen colour display, two USB (type-C) ports, Bluetooth®, SD card slot and four speakers delivering 20 watt output. It also features App-Connect™.

02



03



02 Discover Media satellite navigation system

The optional Discover Media satellite navigation system features an 8 inch colour touch-screen with proximity sensor. The system also includes a 32GB media storage, natural voice control, wireless App-Connect™.

03 Digital cockpit

The optional high-resolution Digital Cockpit immediately impresses with its 26 cm (10.25 inch) display, and operates via the touch screen display of the infotainment system and via the leather-covered multifunction steering wheel. Use the buttons to conveniently scroll through the playlist of your holiday soundtrack or set the safety distance of optional Adaptive Cruise Control*.

Image shows optional Digital Cockpit

*Safety technologies are designed to assist the driver, but should not be used as a substitute for safe driving practices.

- App-Connect is compatible for selected apps with the latest smartphone versions of iOS and Android, active data service, optional connection cable (sold separately).

Arrive Safely.

The modern driver assistance systems.

Driving the Caravelle 6.1 offers high levels of safety and peace of mind, thanks to a host of standard and optional driver assistance systems. Whether you require assistance when parking, driving, changing lanes or towing a trailer, the latest assistants monitor the situation, taking preventative action in critical situations.



Driver Fatigue Detection*. Uses visual and audible warning signals to recommend that the driver takes a break as soon as it registers driving behaviour that indicates fatigue.



Seatbelt warning. Visual warning when the engine is started and an audible warning is emitted, if the driver's seatbelt is not fastened.



Airbags. Driver & passenger front, side and curtain airbags provide the best possible protection in the event of head-on or side impacts.



Cruise Control with speed limiter. At 30km/h and above, the system maintains the set speed throughout uphill and downhill inclines when activated.



Anti-lock Braking System (ABS). Prevents the wheels from locking and thereby maintains manoeuvrability.



Electronic Stabilisation Program (ESP). Standard feature that prevents under- and over-steering through targeted braking of the individual wheels.



Traction Control Systems (TCS). Prevents wheels from spinning excessively.



Electronic Differential Lock (EDL). Distributes the engine torque to the tyres without slippage.

Front Assist with City Emergency Braking*.

Uses a radar system to detect situations where the distance to the vehicle in front is critical and reduces the vehicle's stopping distance. In dangerous situations, the system alerts the driver using visual and acoustic signals, and with a warning jolt of the brakes. | C |

Adaptive Cruise Control (ACC)*.

Automatically adapts the vehicle's speed to that of the vehicle driving in front and maintains the distance set by the driver. | C |

Park Assist*.

Park Assist aids positioning into parking spaces. When reverse is engaged, the vehicle assumes control of the steering. All that's required of the driver is to operate the pedals, whilst keeping a good lookout. | C |

Crosswind Assist*.

The system is a sub-function of the Electronic Stabilisation Program (ESP) that helps dealing with high crosswinds by automatically activating the brakes if needed. | C |

Lane Keep Assist*.

Countersteers if a lane is left unintentionally while alerting the driver at the same time by using a warning tone and information in the multifunction display. | C |

Sensor-Based Side Protection*.

As part of Park Assist, Side Protection monitors the vehicle's sides and alerts you with visual and audible warnings if you're getting too close to other vehicles, pillars, walls or pedestrians. | C |

Multi-Collision Braking.

Triggers braking after a collision, with the aim of preventing secondary crashes, activated when two independent sensors detect an accident. After a short delay, the vehicle begins a phased braking action down to 10 km/h, during which the driver can take over at any time. | C |

Electromechanical power steering.

The speed-dependent steering with active reset improves your driving feeling and safety and achieves steering precision. | C |

Hill Hold Assist.

This prevents the vehicle from rolling back on inclines, making it easier to start off on uphill slopes. | C |

Rear View Camera (RVC)*.

Simplifies parking by showing a limited view of the area behind the vehicle on the display of the radio. Additional guidelines help the driver manoeuvre into the space. | C |

Front and Rear Park Distance Control (PDC)*.

Emits audible warnings when obstacles are detected in front of or behind the vehicle when parking, and also provides a visual display of the vehicle's distance from these obstacles. | C |

Blind Spot Monitoring with Rear Traffic Alert*.

The Blind Spot Monitor with Rear Traffic Alert system supports the driver in assessing and avoiding dangerous situations, especially in critical situations, e.g. city and heavy traffic. The Blind Spot Monitor detects cars and motorcycles in the driver's blind spot and highlights these vehicles via a LED indicator in the door mirror. Rear Traffic Alert warns the driver of approaching traffic at the rear of the car when reversing via an audible warning followed by a visual message in the Optical Parking System (OPS). | C |

Solid paint finishes



Candy White



Ascot Grey



Cherry Red



Pure Grey



Deep Black



Indium Grey



Reflex Silver

Metallic and Pearlescent paint finishes



Starlight Blue



Ravenna Blue



Bay Leaf Green



Mojave Beige



Copper Bronze



Fortana Red

Seat upholstery

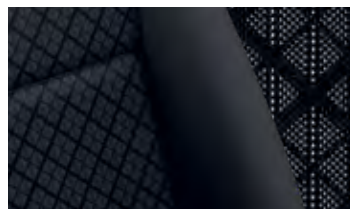

Quadratic
Cloth seat upholstery Titanium Black

Wheels



16" alloy wheel - CLAYTON

Specifications

Engine	2.0 litre TDI340
Type	4 cylinder inline turbocharged direct injection diesel
Max power, kW @ rpm	110 @ 3,250-3,750
Max torque, Nm @ rpm	340 @ 1,500-3,000
Cubic capacity, litres/cc	1,968
Fuel type (recommended)	Diesel DIN EN 590
Fuel tank capacity, L	80
Transmission	7 Speed Direct Shift Gearbox (DSG)
Driven wheels	Front Wheel Drive
BlueMotion Start/Stop system^	●
AdBlue	●
Fuel Consumption **	
Combined, L/100km	6.6

Weights and Capacities

Weights	LWB
	TDI340
Gross Vehicle Weight (GVM), kg	3,080
Unladen Mass ¹ for Standard roof, kg - DSG	2,183
Payload ² maximum for Standard roof, kg - DSG	897
Towing Capacity, kg [‡]	
Braked	2,500
Unbraked	750
Towbar Load Limit, kg	100

Dimensions

Dimensions in mm

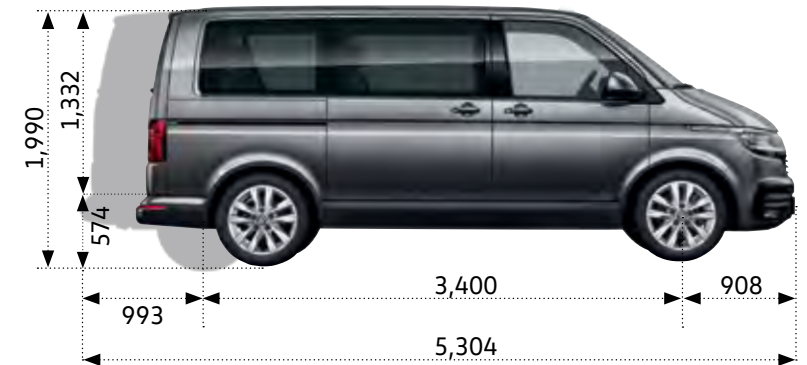
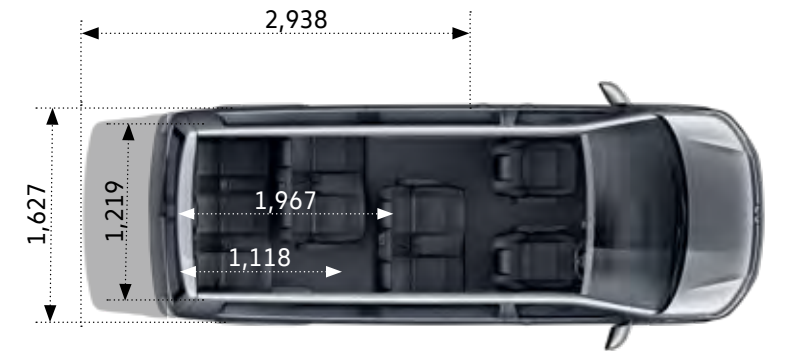

Images shown are for illustration purposes only. Dimensions shown are for Caravelle Long wheelbase only. Short wheelbase is not available.

Full vehicle specifications are available at www.volkswagen.com.au

[^]The Start/Stop system is designed to reduce fuel consumption and CO2 emissions. It achieves this by automatically switching off the engine while the vehicle is stationary and then starting it again automatically when the driver wants to drive off. There are certain operating conditions where the Start/Stop system is deactivated (e.g. during engine warm-up), please refer to the owner's manual for full operating information.

^{**}Fuel consumption figures according to ADR 81/02 derived from laboratory testing. Factors including but not limited to driving style, road and traffic conditions, environmental influences, vehicle condition and accessories fitted, will in practice in the real world lead to figures which generally differ from those advertised. Advertised figures are meant for comparison amongst vehicles only.

1. The Unladen Mass (UM) includes 10L of fuel, vehicle fluids and no occupants. Figures quoted are for base model vehicles only.

2. Payload figures determined by subtracting 'Unladen Weight' from total 'Gross Vehicle Mass' (GVM). A vehicle's final payload, given the different configurations, can only be determined by weighing the individual vehicle and comparing to the known GVM. Figures quoted are for base model vehicles only.

[‡]When fitted with Volkswagen Genuine Tow Bar. Towing capacities are applicable to Volkswagen Genuine Accessory Tow Bar. Towing capacity figures are maximum figures and actual towing capacity depends on factors including the laden mass of the vehicle, driving conditions and fitment of any accessories. Volkswagen Group Australia does not endorse or will not be held liable for any claim, loss or damage arising from the use or fitment of electronic trailer brakes.



5 years Unlimited Kilometre Warranty

At Volkswagen, we pride ourselves on the highest quality standards that come with German engineering.

We back this commitment with a 5 year unlimited kilometre warranty on all new Volkswagen vehicles¹.



1 year Roadside Assist

Every new Volkswagen comes with a 1 year Roadside Assist membership².

That's 24 hour roadside assistance, emergency accommodation, car rental and towing as well as property and other assistance, all included for added peace of mind.



Volkswagen Care Plans

Volkswagen Care Plans³ have you covered for your first 3 or 5 scheduled services, providing you savings off the total Assured Service Pricing RRP. It's convenient, hassle-free scheduled servicing easily available for purchase at your local Volkswagen Dealer.



Assured Service Pricing

Assured Service Pricing⁴ gives you the transparency of knowing how much your service will cost up front.

Our Volkswagen Dealers have access to the latest diagnostic equipment and tools. Plus, they use Volkswagen Genuine Parts[®] to ensure your Volkswagen stays a Volkswagen.

You're in safe hands at your Volkswagen Dealer when it comes to servicing.

1. Conditions and exclusions apply, see <https://www.volkswagen.com.au/en/owners-service/warranty.html>. Your rights under this warranty are provided in addition to, and in some cases overlap with, consumer guarantees under the Australian Consumer Law and do not limit or replace them.

2. Volkswagen Roadside Assist membership is provided by AWP Australia Pty Ltd ABN 52 097 227 177 trading as Allianz Global Assistance. Whenever you request roadside vehicle assistance under your membership, you will be making that request to Allianz Global Assistance, who will provide the services under an arrangement with Volkswagen Group Australia Pty Limited ABN 14 093 117 876. The terms and conditions contain exclusions and limitations, please visit <https://www.volkswagen.com.au/en/owners-service/roadside-assist.html>.

3. Volkswagen Care Plans are available for purchase at <https://www.volkswagen.com.au/en/owners-service/care-plans.html> or from participating authorised Volkswagen Dealers for Eligible Vehicles and covers standard items as contained in each scheduled service interval only. The service intervals occur every 15,000 KM/12 months (whichever occurs first) for all models except MY18 to current Crafter vehicles and MY21 onwards Amarok vehicles, which are scheduled to occur every 20,000 km/12 months (whichever occurs first). These Care Plans can only be purchased prior to the first scheduled service and up to 22,500 km/15 months (whichever occurs first) for all models except MY18 to current Crafter vehicles and MY21 onwards Amarok vehicles which is 30,000 km/15 months (whichever occurs first). The timeframe takes effect from when the vehicle is first reported in our system as 'sold'. Discount structure varies by model. For details of what is not included in a scheduled service, please refer to the program terms and conditions.

4. Assured Service Pricing applies to the first 5 standard scheduled services of your vehicle which are scheduled to occur at every 15,000 km/12 month interval (whichever occurs first) or for MY18 to current Crafter vehicles and MY21 onwards Amarok vehicles only, 20,000kms/ 12 month interval (whoever occurs first). Volkswagen will publish the maximum price for a specified Scheduled Service on 1st February each year (or first business day after this date), and pricing will remain fixed for 12 months only. For more details on the Eligible Model's, pricing, items not included and for full terms and condition, please see <https://www.volkswagen.com.au/app/locals/service-pricing-guide>.

Volkswagen Choice[^]

Guarantee the minimum future value of your Volkswagen

Naturally we understand that your Volkswagen represents a valuable investment, so we understand that you want to maintain it in premium condition. Volkswagen Choice[^] is a finance program tailored to the requirements of Volkswagen owners by providing assurance around your Volkswagen's future value[^], whilst offering simple monthly instalment financing options.

Whether you are selecting your new Volkswagen for business or personal use, you can choose the contract term that best suits your requirements. Enjoy the confidence that comes from having locked in a minimum value up front to be attributed to your vehicle at the end of your contract[^]. There are also no account keeping fees with a fixed interest rate.

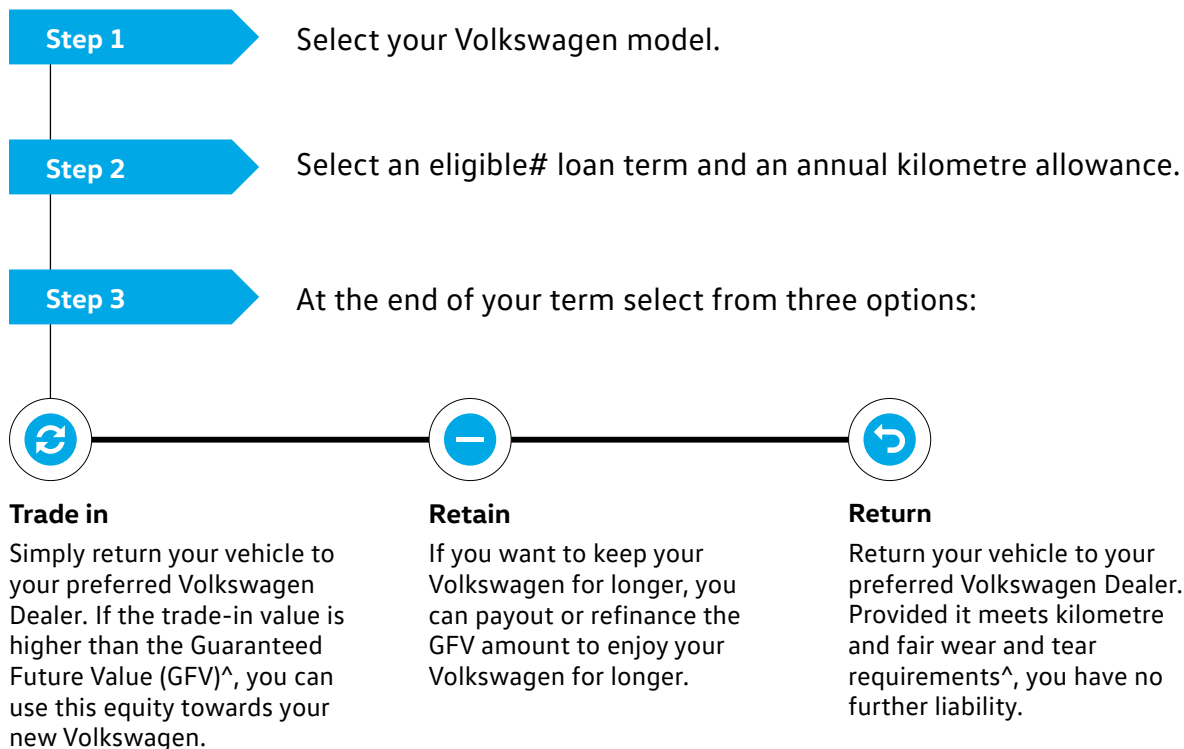

[^]Volkswagen Guaranteed Future Value consists of an option to return your vehicle to Volkswagen Financial Services (VFS) ABN 20 097 071 460, Australian Credit Licence 389344, at the end of the term and requires VFS to purchase the vehicle at an agreed price determined by VFS, known as the Guaranteed Future Value (GFV). #Eligible loan terms include 12-60 months, vary by model and are subject to change, ask dealer for more information. At the end of the term, you can elect to: (1) trade-in; (2) return; or (3) retain the vehicle by paying the GFV, which is a lump sum owed to VFS at the end of the loan term after all repayments have been made. You will be liable for any loan contract deficit and additional charges if you exceed the nominated kilometre allowance and/or the vehicle is not in an acceptable condition. Available on new and demonstrator Volkswagen vehicles for selected models. Contact your Official Volkswagen Dealer to verify eligible vehicles for this program. Fleet, government, rental buyers, hire car and chauffeur companies excluded.

The Caravelle 6.1

Volkswagen Group Australia Pty Ltd
24 Muir Road Chullora NSW 2190
ABN 14 093 117 876

Printed in Australia
December 2021
www.volkswagen.com.au

Publication: VWCCAR6.1MY22

Your Volkswagen Dealer.

Important information

Apple CarPlay® is a registered trade mark of Apple Inc. Android Auto™ is a registered trade mark of Google Inc. MirrorLink® is a registered trade mark of Car Connectivity Consortium LLC. Bluetooth® is a registered trade mark of Bluetooth SIG Inc.

Volkswagen is distributed by Volkswagen Group Australia Pty Ltd (ABN 14 093 117 876) of 24 Muir Road Chullora, NSW 2190. Specifications are as planned at December 2021, for Model Year 2022 and are subject to change without notice or obligation. All information in this brochure are correct at the time of publication, however variations may occur from time to time and Volkswagen, in so far as it is permitted by law to do so, shall not be liable in any way as a result of any reliance by any person on anything contained in this brochure. Authorised Volkswagen Dealers will provide up-to-date information on model application, design feature, prices, and availability on request.